

LINCOLN

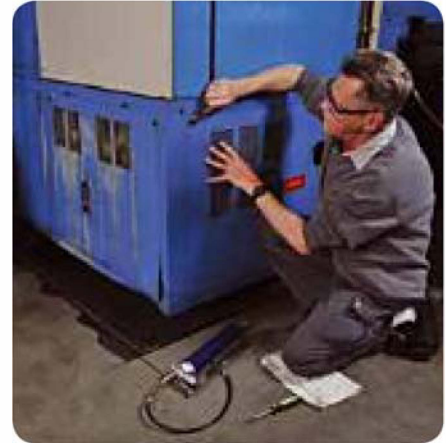


Automatic lubrication systems for industrial applications



SKF

Manual lubrication pitfalls

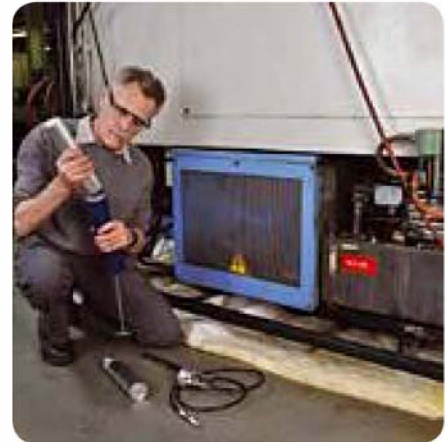


A bearing failure costs much more than the replacement cost of the bearing:

- Loss of production due to downtime.
- Labour for repair.
- Replacement bearings and related materials.
- Production labour cost.
- Missed customer deliveries.
- Increased safety risks when repairing machinery.

Issues with manual lubrication:

- Many machines are dangerous to lubricate while running.
- Safety is an issue when lubricating hard-to-reach bearings.
- Lock-out and tag-out procedures are time consuming and result in lost production.
- Over lubrication can cause product spoilage, bearing seal damage and cleanup issues.
- Under lubrication will cause bearing damage and premature failure.



Labour cost for manual lubrication can be significant:

- Today's machinery has guards and covers that make access to lubrication points difficult or impossible while machinery is operating.
- Removing guards and covers is time consuming.

Why bearings fail

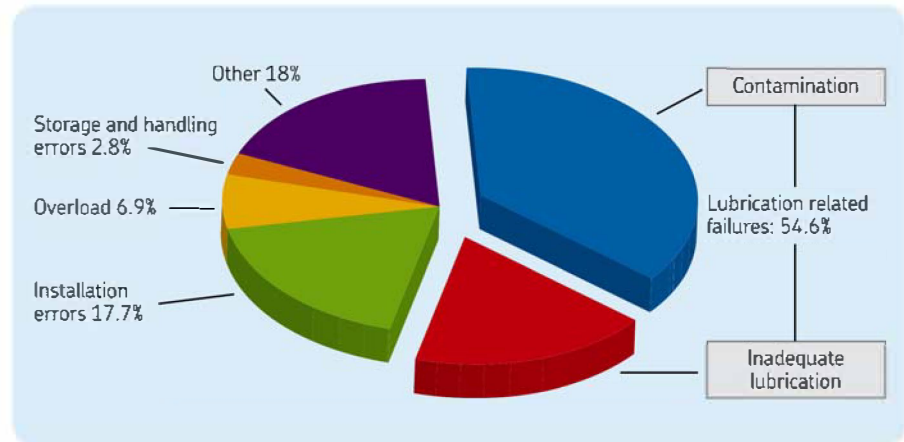
Lincoln systems can eliminate up to 50 percent of bearing failures in many applications

- 54 percent of bearing failures are attributed to inadequate lubrication or contamination.
- Too little grease, too much grease and not greasing often enough can impact bearing life significantly.

Why Lincoln automatic lubrication systems?

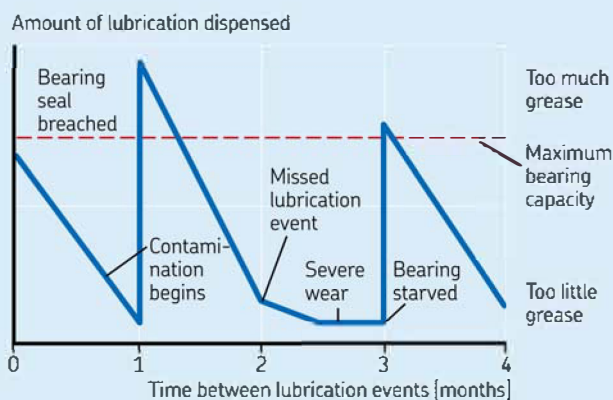
- Manual lubrication typically produces inconsistent lubrication. The uneven lubrication cycle leads to wasted lubricant and allows contaminants to enter the bearing – producing premature wear.
- Consistent lubrication (small, precise amounts applied frequently) extends bearing life and prevents unplanned downtime.

Small, frequent amounts of lubricant while the bearing is in motion will increase the bearing life.

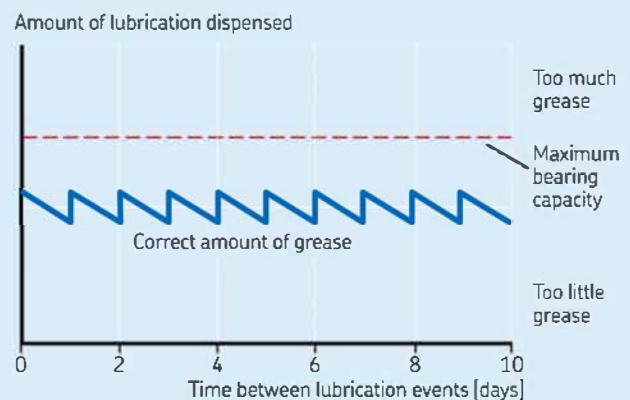


Source: TAPPI 1995 Engineering Conference

Manual lubrication cycles



Automatic lubrication cycles



What is an automatic lubrication system for bearings?

A typical automatic system (grease or oil) includes a pump, controller/timer, lubricant supply line, metering devices and lubricant feed lines. Many of Lincoln's pumps integrate the reservoir, controller and fault monitor capability in one unit for design simplicity and reduced installation cost.

During a lubrication cycle, the pump delivers lubricant through a supply line to

the metering devices (typically injectors or divider valves). A small, preset amount of lubricant is dispensed from a positive-displacement metering device to each bearing through feed lines. A lubrication cycle can be initiated by a programmable logic controller (PLC), machine function or by an integrated timer.

Depending on the type of Lincoln system, it is possible to monitor for proper system operation, blocked line detection and low-reservoir level. Alarm signals can be connected to a PLC, light or horn for remote notification. Injector systems (Centro-Matic) have adjustable output for each point.



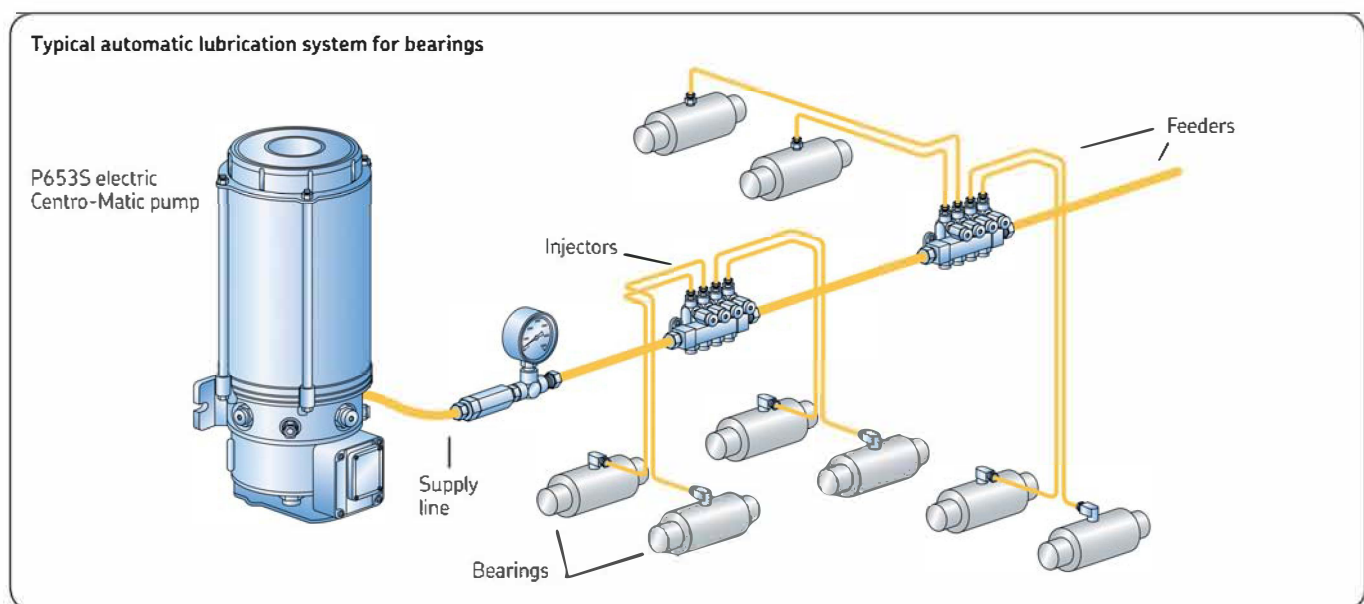
Pump, reservoir and controller



Metering device – injector or divider valves



Bearing



Reasons to consider automatic lubrication

Benefits you can expect from a Lincoln automatic lubrication system

Lower maintenance cost

- Bearing, gear and chain life are increased by applying small, measured amounts of lubricant frequently, while the machine is operating.
- Labour for manual, point-by-point lubrication is virtually eliminated – no more lock-out and tag-out and no removing guards and covers to access manual lubrication points.
- Labour for repair is reduced due to fewer bearing failures.

Increased production

- Reduces lost production due to required machine shut down (lock-out and tag-out procedures) for manual lubrication.

Improved safety

- Helps prevent accidents that can occur during manual lubrication.

Lower energy cost

- Improved lubrication for bearings, gears and chains translates to lower friction and lower energy cost.

Environmental improvements

- Lincoln systems measure the exact amount of lubricant required. Waste, product contamination and house-keeping issues are substantially reduced.

Today's reality

In many plants, maintenance departments are downsizing, yet there are still the same number of production machines and lubrication points that require manual lubrication. Due to competitive demands, most industries are under increased pressure to be more efficient and improve uptime.

Increased regulations that focus on the environment and safety (lock-out and tag-out procedures) require plant maintenance managers and personnel to follow time-consuming tasks.

With our extensive experience in lubrication equipment and systems, we have the unique capability and system solutions to address these important issues. These universal challenges will not go away.

Manual lubrication is not consistent with pro-active maintenance strategies and a goal of lowering overall cost.

CAUTION

For all systems described in this brochure, see important product usage information on the back cover.

Applications: Single-machine bearing lubrication

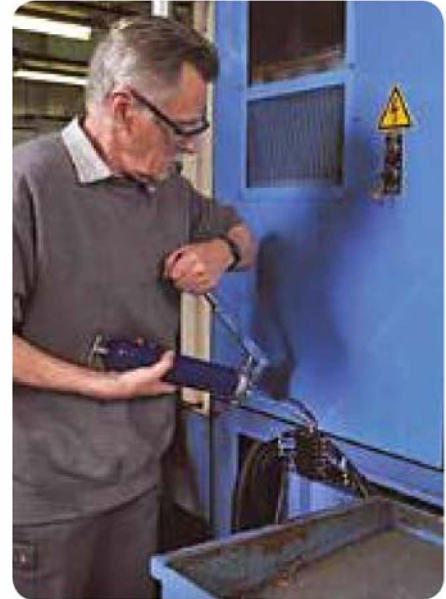


This Centra-Matic automatic electric pump and injectors are lubricating bearings in a very abrasive and dusty environment.

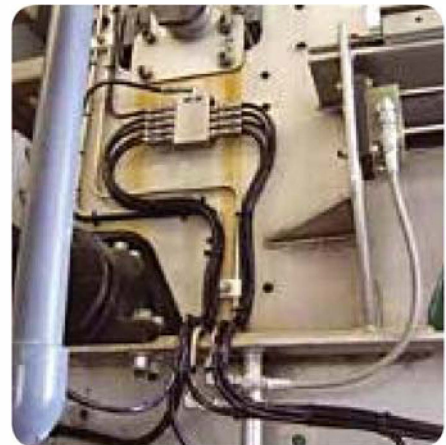
Lincoln manufactures and designs automatic lubrication systems for a wide range of machines and industries. Our Centra-Matic, Quickclub and Modular Lube product lines offer integrated pump packages that include a reservoir, controller and fault monitoring. From food, beverage, paper, metal forming, power generation, automotive and general manufacturing, Lincoln systems (both grease and oil) are designed to handle the harshest environments, including high heat and corrosive environments. These system packages are for individual machines for any application.



This Lincoln Quickclub QLS oil system virtually eliminates manual lubrication on bearings and gears for this printing press. Lubricating on-the-fly improves productivity.



This single-point metering valve enables this technician to lubricate ten bearings without removing any guards or shutting down the production line.



In this corrosive environment, a stainless steel Lincoln Quickclub system is lubricating and purging 32 points on a belt press in a wastewater plant.

Applications: Multiple or large machine lubrication



A maintenance technician is adjusting injector output to one bearing on a roll forming machine. More than 100 points are being lubricated from one pump without shutting down the machine.



These Lincoln pumps deliver grease directly from a 400 lb. (181 kg) drum to 200 SL-V injectors located approximately 250 ft. (61 m) away in a steel mill.

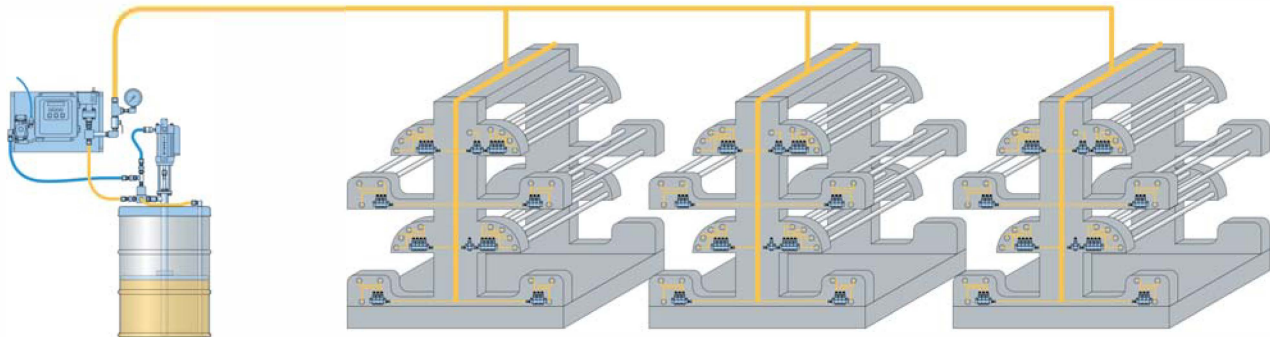


These SL-V injectors operate in a harsh steel mill environment that includes high heat and abrasive contamination. Purging the bearings, replacing the grease film frequently and increased safety are key benefits of this system.

For larger machines and production lines, Lincoln offers systems to lubricate hundreds of bearings that pump directly from refinery drums or bulk tanks. Examples include paper machines, packaging, assembly and food processing lines, steel mills and groups of machines. These systems are capable of pumping long distances, and the adjustable metering valves (injectors) help to ensure

each bearing receives the correct amount of lubricant. Additional lubrication points can be added for future expansion. Lincoln also offers zoning valves that lubricate only the operating machines.

Large drum pump systems can service hundreds of bearings



Applications: Chains

Effective and clean lubrication for chains is an issue for many maintenance managers. Lincoln has the answer with three types of systems – brush, precision spray and metered squirt. Chain life is significantly increased, and chain stretch is significantly reduced when lubricated with a Lincoln automatic system.

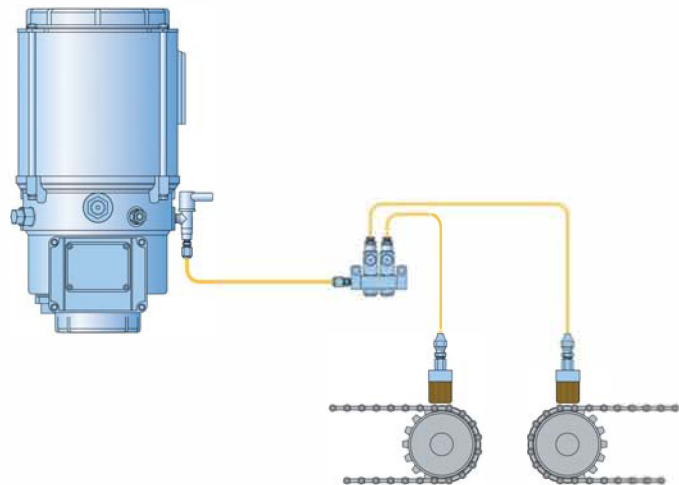
Lincoln offers the latest technology in chain lubrication. Our unique systems deliver the precise amount of oil required to effectively lubricate all types of chains without contaminating product. Each system is custom designed for the

application. Typical chain applications include power and free conveyors, paint lines, ovens – anywhere that a precise amount of oil is required.



Lincoln automatic brush-style systems are both an effective and a low-cost solution.

Automatic brush system
No air required

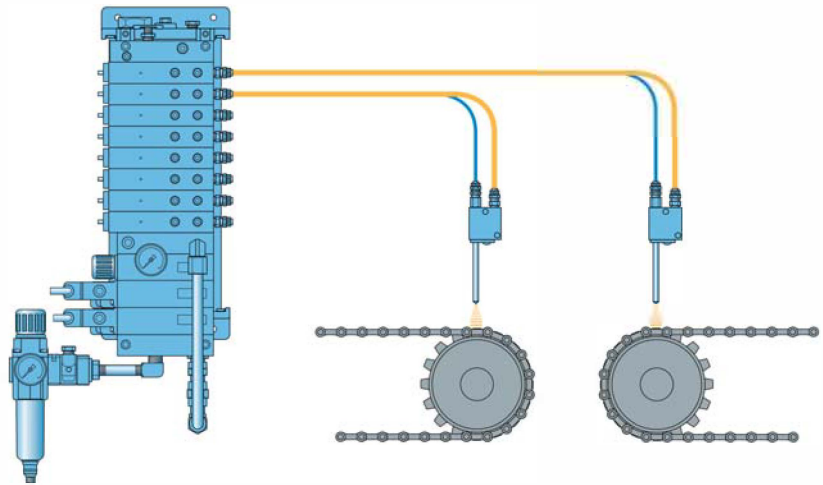


Lincoln offers three solutions for chain/oil applications



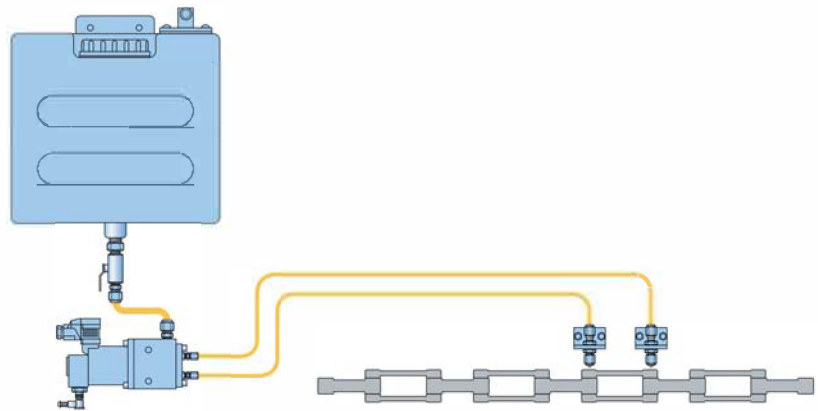
An Orsco VSR system lubricates a conveyor chain on an oven application in a food plant.

Automatic Orsco spray system
Air required

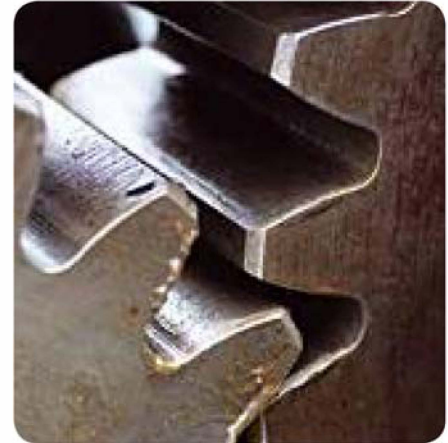


The PMA solenoid pump is designed for contact-free oil lubrication of the chain. The exact metered amount of oil is applied to the chain pins only.

PMA metered squirt system
No air required



Applications: Bull and pinion gears



Large and expensive gears found on kilns, ball mills, rod mills, coal pulverizers and other rotating vessel and machine applications require consistent, frequent lubrication to protect them from premature gear wear.

Lincoln offers three ways to lubricate large gears with grease – air-assisted spray, airless grease spray and lubricating pinion greaser. These Lincoln systems are simply the most efficient means to apply most of the latest tacky bull gear lubricants.

Airless spray system

The Lincoln airless spray system warms the grease to eliminate freeze-ups and will operate in a wide range of temperatures. Unlike air-assisted spray, the airless spray system is more consistent, has less overspray and offers a wider range of spray patterns. By applying lubricant only to the wear side of the gear, lubricant consumption and cleanup is reduced. Both air-assisted spray and airless spray systems are designed to pump from a drum or bulk tank that is remote from the spray panel or spray box.



Airless grease spray systems

This expensive gear on a rotary kiln is protected by Lincoln's airless spray system. Note the spray box is mounted on an access door to the enclosed gear for inspection purposes. The pump is located one level below.



Pinion lubricator (for slower moving gears)

Lincoln's new lubricating pinion greaser is mated to the bull gear and helps to ensure each gear tooth receives a film of lubricant. The lubricating pinion is typically connected to a Lincoln injector or divider valve that meters the grease.

The Lincoln lubricating pinion has been designed especially to reduce the wear on the tooth flanks, where material stress is highest.

An optimum lubricant film is achieved thanks to the special design of its tooth profile. Models are available for specific size gears.

Your Lincoln representative can explain which applications work best with this type of system.

Centro-Matic



P653 electric automatic pump with an 2.1 gallon (8 liter) reservoir and integrated controller (available in AC or DC voltages)

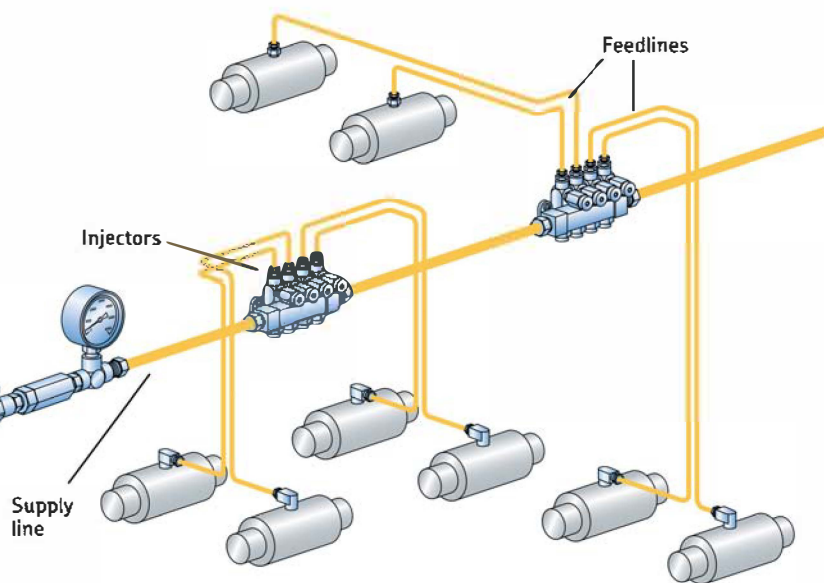
System features

- Extremely flexible
 - Easy to add or subtract lubrication points.
- Adjustability
 - Injector outputs are adjustable – down to 0.001 cubic inches (0,016 cm³).
- System monitoring
 - Alarm systems are available to monitor pressure, low reservoir level and the flow of lubricant at the bearing (System Sentry).
- Capable of pumping long distances
 - More than 300 ft. (91,4 m) with grease, pressures up to 6 000 psi (414 bar) depending on the injector and pump models.
- Large number of bearings
 - Over 500 lubrication points (depending on bearing size).
- Excellent in harsh conditions
 - Injectors are available for high heat, up to 350 °F (177 °C), and corrosive environments (stainless steel models available).
- Wide range of pumps
 - Pneumatic, hydraulic, electric and manually operated.
- Wide range of pump reservoirs
 - From 1 to 400 lb. (0,45 to 181 kg) drums or bulk tanks.

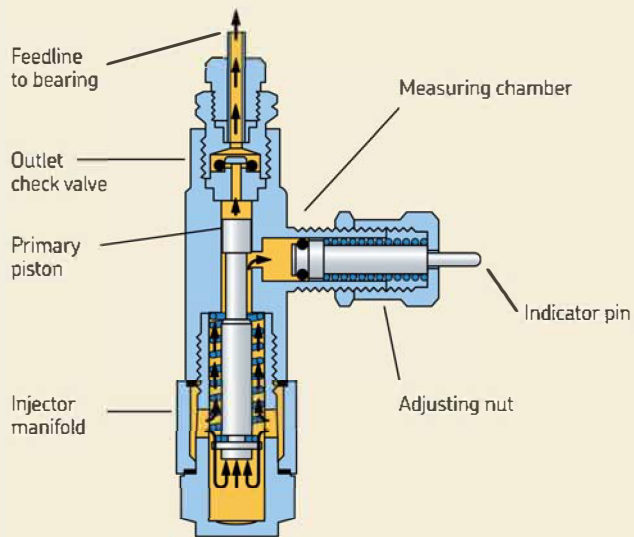
System overview

A pump automatically develops lubricant pressure through a single supply line to the injectors. Each injector services one lubrication point and may be accurately adjusted to deliver the precise amount of grease or oil required for each bearing. Both oil and grease injectors are available in various output ranges, in stainless steel and in high-heat models.

Pneumatic integrated Centro-Matic pump
Electric, hydraulic, and manual pumps are available.



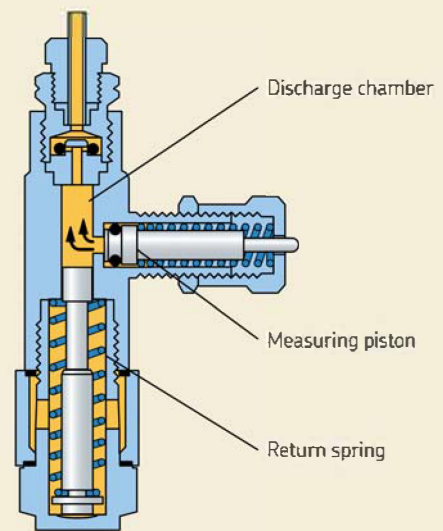
How the Centro-Matic injector series (SL-32, 33, 42 and 43) works



Stage 1 – pressurised

Incoming lubricant, under pressure from the pump, moves the primary piston forward.

The primary piston forces a pre-charged amount of lubricant from the discharge chamber through the outlet check valve through the feed line to the bearing. Simultaneously, lubricant fills the measuring chamber and pushes the indicator pin out.



Stage 2 – relieved (vented)

When the system is vented (pressure relieved), the primary piston returns to the rest position, allowing the measuring piston to transfer lubricant to the discharge chamber for the next cycle.

Top-adjusted injector models operate on a different principle with similar features



Stainless steel SL-32 grease injectors are used here to prevent corrosion from daily wash-down maintenance practices at this food plant.



Injectors are typically mounted in manifolds. The number of grease or oil injectors in a manifold ranges from one to 15 depending on the series.

Quicklub

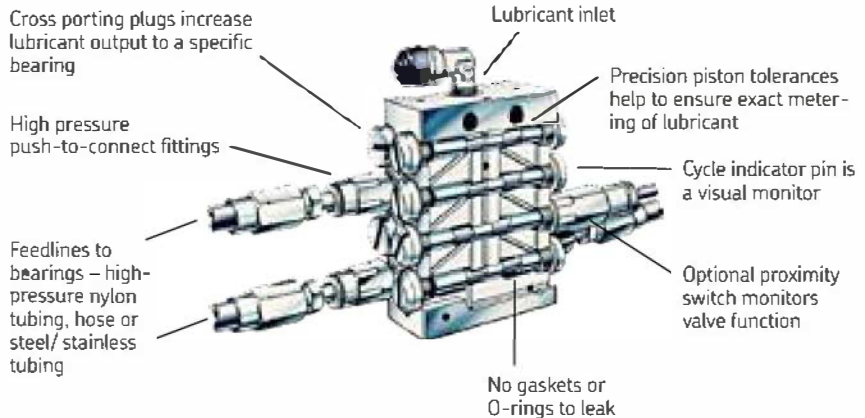
System overview

A pump (grease gun or automatic) delivers lubricant to a Quicklub valve(s) that incorporates a series of metering pistons which accurately dispenses lubricant from each outlet. The metering valve can be cross ported to supply a variety of bearing sizes. Quicklub valves work with grease or oil.

Valve features

- Quicklub metering valves use positive displacement to help ensure accurate delivery of lubricant.
- Valves are made of solid steel, one-piece construction; no seals, O-rings or springs to wear out and leak.
- Verify operation with visual indicator pins.
- Operating temperature from -22 to $+212$ °F (-30 to $+100$ °C)
- Capable of detecting a blocked line or bearing.
- Valves can be cross ported to deliver more lubricant to a larger bearing.
- Valve outlets range up to 18.
- Stainless steel Quicklub valves are available.

Lincoln Quicklub SSV metering valve



Pump features

- No air required
 - Available in 12 and 24 V DC and 120 and 240 V AC models.
- Wide range of reservoir sizes
 - From 34 oz. to 4 gallon (1 to 15 liter), grease or oil.
- Integrated alarm options
 - For low reservoir and blocked lubrication line detection.
- Flexible control options
 - Integrated controls or PLC-compatible models.
- Wide range of lubricants
 - Pumps are capable of handling most industrial greases or oils.
- High-pressure capabilities
 - Quicklub pumps can develop up to 4 000 psi (276 bar), which provides lubricant delivery to each bearing.
- Data logging
 - Pump models are available that store system operation history.
- Manual override fitting
 - You never lose the ability to lubricate your machine, even if the pump requires service.



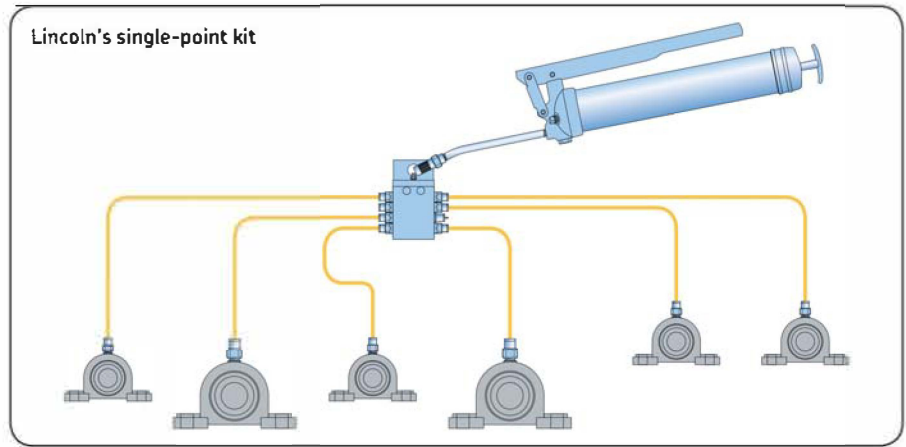
QLS electric pump with 34 oz. (1 liter) reservoir



Model 233 2 gallon (8 liter) data logging pump and SSV metering valves

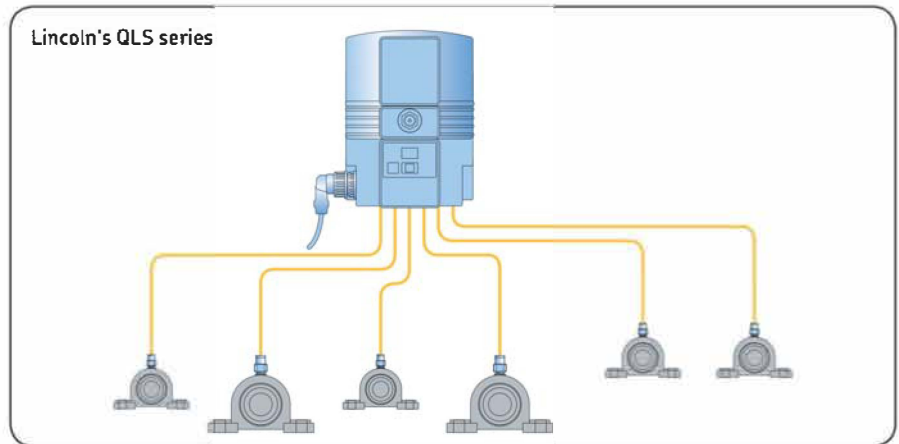
Manual single-point kits

- Lubricate bearings from one easily accessible location on a machine (up to 18 bearings from one divider valve).
- Metering piston provides each bearing with the correct amount of grease.
- Valve can accommodate various bearing sizes.
- Easily upgrades to an automatic system.
- Inexpensive and easy to install – includes all hardware: tubing and push-to-connect fittings.



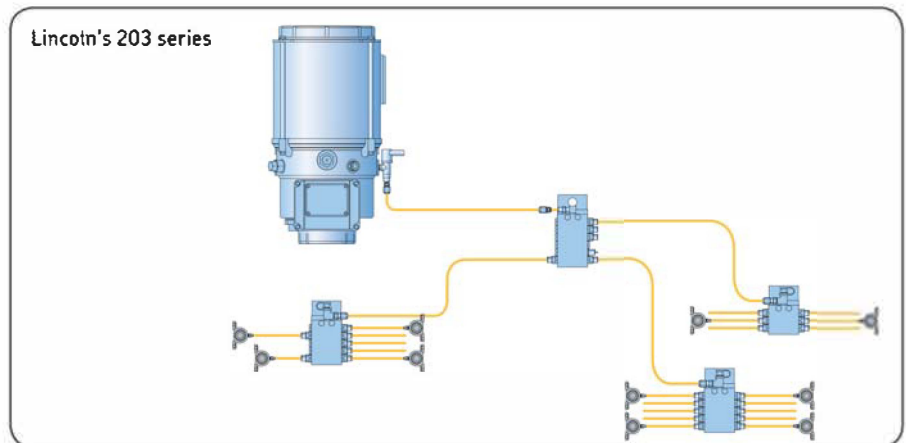
Automatic – low cost QLS systems

- Complete lubrication system "in a box" – just add tubing and fittings.
- Automatically lubricates up to 25 points (depending on the bearing size and pump model).
- Timer, reservoir and metering valve are integrated – AC and DC voltage models.
- Push-to-connect fitting makes installation quick and easy.
- System fault-monitoring capability.
- Manual override fitting allows for lubrication if the pump needs service.
- Grease or oil systems available – 34 oz. (1 liter) reservoirs.



Automatic – larger 203 and 233 series system

- Capable of handling more than 50 bearings (depending on their size).
- Many pump configurations offered – AC and DC models.
- Reservoirs range from 68 oz. to 4 gallon (2 to 15 liter).
- Flexible timer options or PLC-controlled.
- System monitoring – blocked line and optional reservoir level.
- Manual override fitting allows for lubrication if the pump needs service.
- Data logging capability available.
- Grease or oil systems available.
- Capable of pumping grease long distances.
- Push-to-connect fitting makes installation quick and easy.



Orsco chain lubrication

System overview

Lincoln's Orsco system is state-of-the-art technology for chain lubrication. The major difference between the Orsco oil lubrication system and other lubrication technologies is the use of a continuous, ultra-fine, non-misting delivery of lubricant.

In applications where cleanliness is critical, the Orsco system achieves exceptional performance. The Orsco system has the capability to spray one drop of oil continuously for more than one minute. Each system is custom designed for the application.

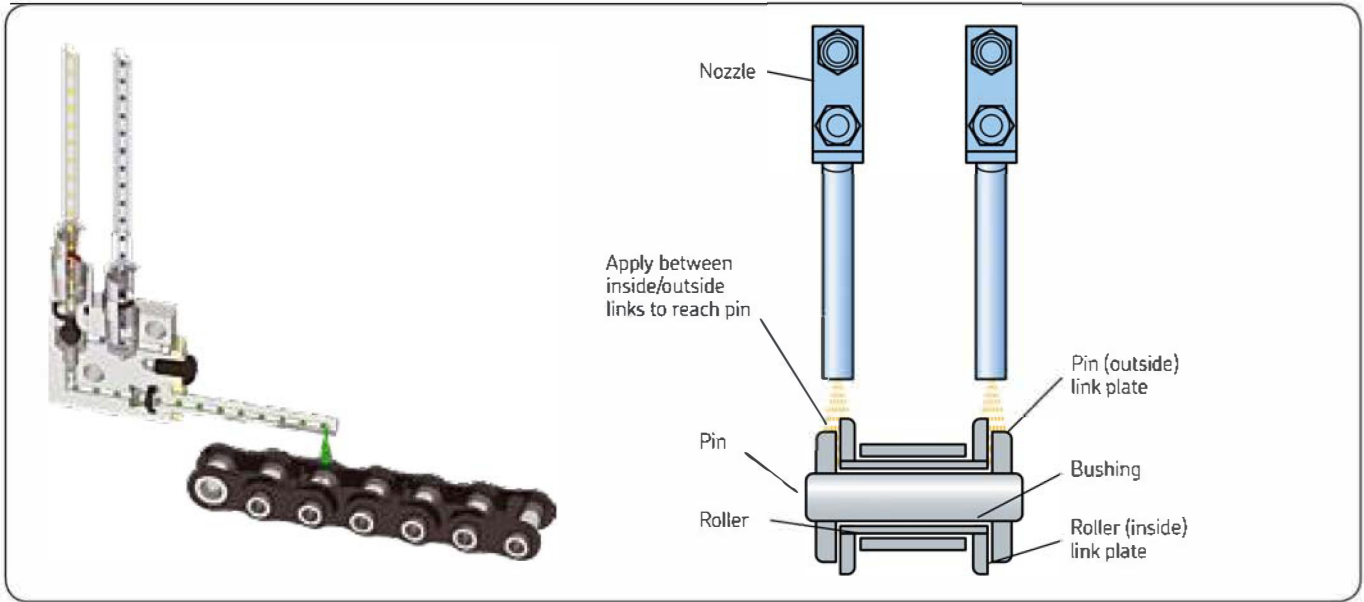
Typical chain applications include power and free conveyors, paint lines, ovens – anywhere that precision chain lubrication is required.

How the Orsco system works

An Orsco or customer-supplied controller cycles the air-operated injectors that deliver small metered amounts of oil through tubing to the nozzles. The nozzles mix the oil with air and create a consistent, continuous spray that will not mist and become airborne. For larger chain and other applications, the Orsco system can be designed to spray intermittently (*image 1*).

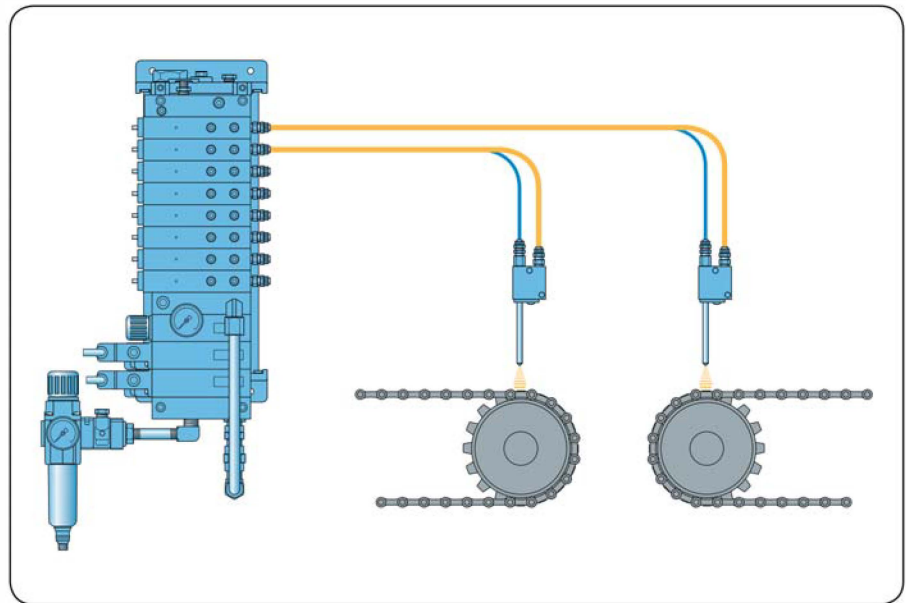


Image 1. Both the chain pins and wheel bearings on this overhead conveyor are being lubricated with four nozzles. A proximity switch times the intermittent spray to only lubricate the wear points.



Features and benefits

- Increases chain life
 - Applies minute quantities of oil continuously between the inside and outside link plate and other wear points.
- Saves lubricant
 - Applies only the required amount of oil with virtually no waste.
- Improves safety
 - Keeps personnel away from potentially hazardous equipment and will not create slippery areas due to over lubrication.
- Reduces power consumption
 - Optimizes the application of oil applied to the chain. Friction is reduced which translates to lower energy costs.
- Reduces chain stretch
 - Through improved lubrication and less friction and wear.
- Cuts downtime
 - Virtually eliminates lock-out and tag-out procedures for scheduled manual lubrication and frequent chain replacement.



Specialty application systems



Modular lubrication systems and box lubricators

Lincoln offers a comprehensive line of high-pressure oil lubrication systems found primarily in the petrochemical and natural gas processing industries.

Other applications include rubber batch mixers, refrigeration compressors and small oil recirculation packages.





Systems and replacement components for heavy-duty process equipment

Steel, cement, paper, chemical, automotive, glass and other heavy industries use lubrication systems that come from many countries. Lincoln offers a wide line of systems and products that are a direct replacement for these components. This includes dual line grease systems, pump-to-point systems and recirculating oil systems.

Specialty chain applications requiring grease

Lincoln's Cobra system is designed to lubricate the rollers of large conveyors and power-free chains while they are in operation.

The Cobra system delivers a metered amount of lubricant to the roller's grease fitting and pumps from a refinery pail or drum. These systems are typically found in cement, steel, automotive and other industries with heavy-duty conveyors.



General lubrication equipment

Overview – manual lubrication

There will always be some necessity to perform manual lubrication. Lincoln offers a wide range of lubrication tools and systems including battery-operated grease guns, transfer pumps, hose reels, meters, in-plant lubrication trucks, bulk tank systems, waste oil systems and fluid inventory control systems.



Lincoln offers six models of battery-powered grease guns



Lincoln offers a wide variety of transfer pumps ranging from diaphragm, piston and manual



Transferring fluid lubricants and grease from bulk tanks is both cost effective and environmentally sound. These bulk tank systems help to eliminate drum disposal and the meters will track the volume of lubricant that is dispensed for each product.



In-plant lubrication trucks take all the important fluid lubricants to the machinery. This electric cart even includes a waste oil evacuation system.

Solutions for all applications

	Centro-Matic	Quicklub	Modular Lube	Box lubricators	Orsco	Grease spray	PMA system
Bearings	X	X	X	X			
Slides	X	X	X	X			
Gears	X	X	X		X	X	
Chains	X	X	X		X		X
Cams	X	X	X	X	X		X

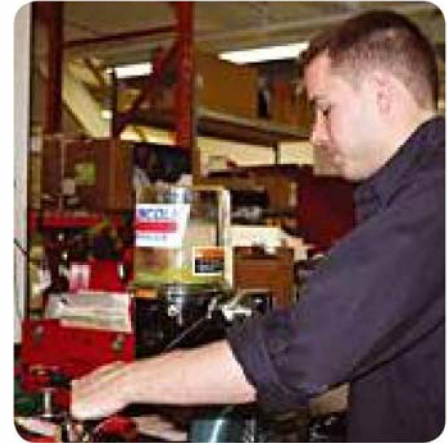
Frequently asked questions

- How can you tell if a Lincoln grease system is not working properly?
 - Many of the Lincoln systems offer monitoring capabilities to indicate if the system is malfunctioning, has a blocked line or if the reservoir level is low. The alarm signal can be connected to a light, horn or PLC.
- How do I get my Lincoln systems installed and serviced, if required?
 - Authorized Lincoln systems house distributors have the capability to install, design and service all of the Lincoln automatic lubrication systems. Visit www.lincolnindustrial.com to find the nearest systems house distributor.
- How far can I pump grease in a lubrication system, and how many bearings can I lubricate with one system?
 - Depending on the system design, ambient temperature and grease viscosity, our Centro-Matic systems can pump more than 300 ft. (92 m) and lubricate more than 500 bearings (depending on their size).
- Does Lincoln offer stainless steel and high-heat capable lubrication systems?
 - Yes. Lincoln offers many stainless steel metering valves/injectors. We have special heat-resistant injectors and divider valves that are capable of operating in temperatures up to 350 °F (177 °C).
- Do I need to use a special grease in the Lincoln automatic lubrication systems?
 - No. Lincoln grease systems are capable of pumping most NLGI 1 or 2 greases sold for industrial applications. Contact your local Lincoln systems house distributor for details.
- Can I use my machine PLC to control the lubrication system?
 - Yes. Lincoln offers many pumps without built-in controllers just for this situation.
- What is the coldest temperature a Lincoln system can handle?
 - In most cases, the limiting factor is the lubricant. We have systems operating in -40 °F (-40 °C). Consult your local Lincoln systems house distributor for details and recommendations on the system design.
- How do I adjust my system if more or less lubricant is required at one point or all points?
 - Most Lincoln systems have an adjustable timer that allows you to control how often the system will cycle. The Centro-Matic system offers lubricant output adjustability for each bearing, on grease or oil systems.

Lincoln distribution support



Our systems house distributors offer turn-key solutions and aftermarket support. They are factory trained and maintain local inventory of system components and repair parts.



Lincoln systems house distributor capabilities include:

- Application design and system recommendations.
- Turn-key installations and custom kits.
- In-plant service and repair.
- Training.
- Warranty support.
- System maintenance contracts.
- Plant surveys.
- Return-on-investment (ROI) analysis.



Ask your local Lincoln systems house distributor for a lubrication system plant audit

- Learn about your hidden lubrication-related costs.
- Know the return on investment of automating your plant's lubrication requirements – for each application.
- Understand the safety and environmental improvement potential.
- Create a customized plan to reduce cost and improve productivity, safety and the environment.

Return-on-investment (ROI) calculator

Many Lincoln automatic lubrication systems provide a payback in less than a year. Use this return on investment calculator to determine your specific savings and payback. The saving percentage is based on Lincoln's experience and customer feedback. If necessary, adjust these percentages to fit your application or experience.

Contact your local Lincoln systems house distributor to receive a system cost estimate, formal proposal or a return-on-investment report for each application.

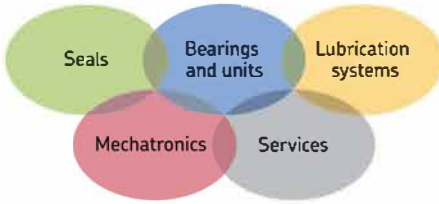
Annual maintenance and lubrication-related cost and payback analysis

Description of annual cost	Cost	Savings %	Savings
Labour for manual lubrication	\$ _____	90%	\$ _____
Labour to repair bearing failure	\$ _____	50%	\$ _____
Replacement bearing material cost	\$ _____	50%	\$ _____
Lost production due to bearing failure(s)	\$ _____	50%	\$ _____
Lost production due to manual lubrication	\$ _____	100%	\$ _____
Grease savings	\$ _____	50%	\$ _____
Safety improvement factor	\$ _____	_____ %	\$ _____
Other _____	\$ _____	_____ %	\$ _____
Other _____	\$ _____	_____ %	\$ _____
Totals	\$ _____	_____ %	\$ _____

System cost \$ _____ Payback: _____ months
 Payback = (System cost/savings) x 12

All savings numbers are rounded off and based on customer estimates. Your particular cost savings may vary.

Your Lincoln district manager or Lincoln systems house distributor can assist in developing a return-on-investment report using your cost numbers.



The Power of Knowledge Engineering

Drawing on five areas of competence and application-specific expertise amassed over more than 100 years, SKF brings innovative solutions to OEMs and production facilities in every major industry worldwide. These five competence areas include bearings and units, seals, lubrication systems, mechatronics (combining mechanics and electronics into intelligent systems), and a wide range of services, from 3-D computer modelling to advanced condition monitoring and reliability and asset management systems. A global presence provides SKF customers uniform quality standards and worldwide product availability.

! Important information on product usage

All products from SKF may be used only for their intended purpose as described in this brochure and in any instructions. If operating instructions are supplied with the products, they must be read and followed.

Not all lubricants are suitable for use in centralized lubrication systems. SKF does offer an inspection service to test customer supplied lubricant to determine if it can be used in a centralized system. SKF lubrication systems or their components are not approved for use with gases, liquefied gases, pressurized gases in solution and fluids with a vapor pressure exceeding normal atmospheric pressure (1 013 mbar) by more than 0,5 bar at their maximum permissible temperature.

Hazardous materials of any kind, especially the materials classified as hazardous by European Community Directive EC 67/548/EEC, Article 2, Par. 2, may only be used to fill SKF centralized lubrication systems and components and delivered and/or distributed with the same after consulting with and receiving written approval from SKF.



Please contact:
SKF USA, Inc.
 One Lincoln Way
 St. Louis, MO 63120 USA
 Tel. +1 (314) 679-4200

This brochure was presented by:



© SKF is a registered trademark of the SKF Group.

© Lincoln, Quicklub, Centro-Matic, System Sentry, Modular Lube and Orsco are registered trademarks of Lincoln Industrial Corp.

© SKF Group 2013

The contents of this publication are the copyright of the publisher and may not be reproduced (even extracts) unless prior written permission is granted. Every care has been taken to ensure the accuracy of the information contained in this publication but no liability can be accepted for any loss or damage whether direct, indirect or consequential arising out of the use of the information contained herein. Any cost savings and revenue increases in this publication are based on results experienced by SKF customers and do not constitute a guarantee that any future results will be the same.

SKF PUB LS/P2 13617 EN · March 2013 · FORM 444055

