

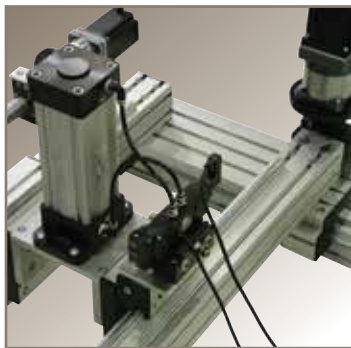

aerospace
climate control
electromechanical
filtration
fluid & gas handling
hydraulics
pneumatics
process control
sealing & shielding



T-Slot Aluminum Framing

Parker Industrial Profile Systems

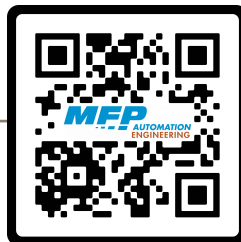

ENGINEERING YOUR SUCCESS.

T-Slot Aluminum Framing Solutions

Everything You Need to Build *Anything*

Parker's extensive line of structural T-slot aluminum extrusions, fasteners, panels, doors, hardware and accessories can be configured to meet any design challenge with a durable, high performance solution.



Cabinets and Storage



Material Handling Systems



Test Station with Granite Top



Factory Lean Solutions

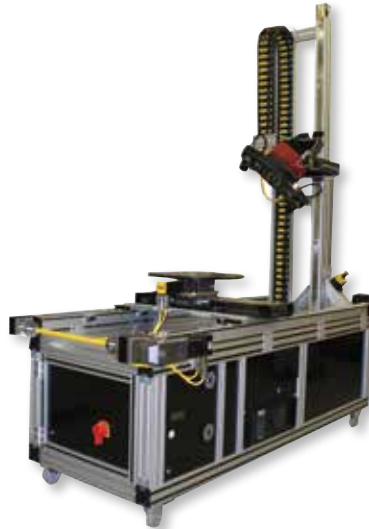

Portable Gantry System



Machine Bases and Frames

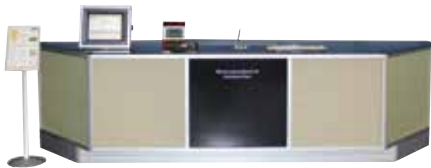

Front Office Reception Desk



Workstations and Tables

NEW!

Factory Lean Solutions

Parker has introduced a series of standard lean factory solutions such as team tracking and communication boards and day by the hour boards using our modular T-slot aluminum framing system. These systems can be ordered as a kit or an assembly.



www.parker.com/FactoryLeanSolutions

Service and Support: When, Where & How You Need It

Customer satisfaction is key to your success, and ours. Our nationwide network of IPS service centers and distributors provide the right level of product and engineering expertise and response to support your needs.



Wadsworth, OH



Rohnert Park, CA



IPS Service Centers

- **Plant locations in Wadsworth, OH and Rohnert Park, CA**
- **Parts, accessories and extrusions in stock**
- **Engineering capabilities for kits and assemblies**
- **Machining services: cutting, tapping, drilling and counter boring**
- **Assembly services**
- **Factory direct customer service support**



Authorized Design Centers

- **Locations across the country**
- **Local inventory of most parts, accessories and extrusions**
- **Engineering capabilities for kits and assemblies**
- **Machining Services: cutting, tapping, drilling and counter boring**
- **Assembly services**
- **Factory trained staff**



Authorized Distributors

- **Locations across the country**
- **Local support**
- **Other value added services**
- **Factory trained staff**

Online Tools

www.parker.com/ips



Parker IPS offers the tools needed to design and develop your assembly solution. Use our website for access to the industry's most comprehensive resource for:

- **Complete selection and specification information on all IPS products available on-line in pdf format**
- **Native SolidWorks® and Inventor® 3D CAD files libraries available for download or on USB for all IPS products**
- **Training materials**
- **Support and downloads**
- **Rapid quote requests**
- **Distributor/Design Center Locator**

Avoid paying too much for an over-engineered solution, contact our applications team today at 800.333.4932 for quick response and help with designing the best solution.

SolidWorks® is a registered trademark of Dassault Systemes Solidworks Corp.
Inventor® is a registered trademark of Autodesk Inc.

Think it. Design it. Build it.

From Concept to Completion.

Turn your brainstorm into an application quote in as little as 24 hours – Parker's IPS network can help!

Are other structural aluminum providers unable to provide the right solution? Are you considering using aluminum over traditional welded steel? We can convert pen or pencil sketches into final drawings and quotes, often saving you time and money.

Parker can also supply engineered kits or sub-assemblies to make your next project flow smoothly. Most quotes can be turned around quickly.

Call **800-333-4932** to discuss your requirements with an applications engineer.

Typical Applications

- Motion systems integration
- Enclosures and guarding
- Machine bases and frames
- Workstations and tables
- Material handling systems
- Lean manufacturing tools
- Clean room applications
- Conveyor frames
- Test equipment
- Tool racks
- Test tables
- Trade show booths
- Store fixtures
- Sound enclosures

Markets Served

- Aerospace
- Automotive
- Educational
- Industrial manufacturing
- Medical
- Packaging
- Pharmaceutical
- Plastics
- Semiconductor
- Textiles
- Tires

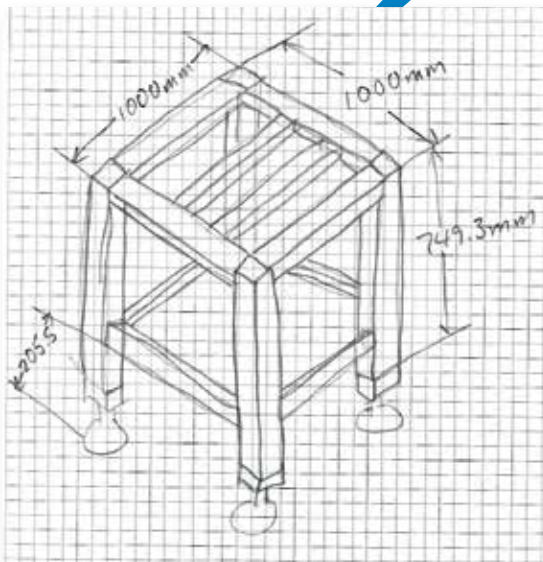
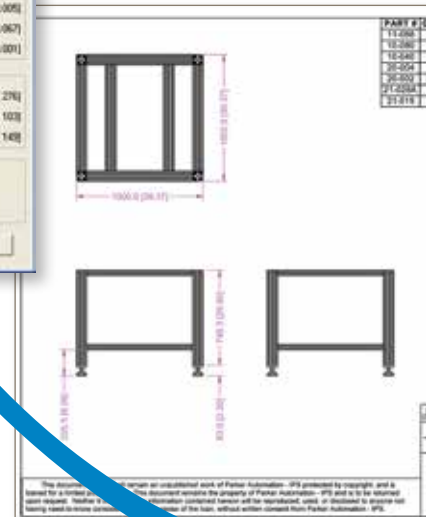
Need a Quote in a Hurry?

Parker IPS has the engineering experience to make ground-up system development quick and easy. Let us assist you in designing your next system from concept to completion.

The IPS team of engineers is available to help design systems to ensure perfect field integration. IPS solutions are custom fabricated and shipped installation ready as a kit or complete assembly.



Machine Services

- Cutting
- Tapping
- Drilling
- Counter boring

Custom services also available by our expert machinists to meet your exact requirements.

Value Added Services

- Metric and Imperial design catalog
- Parker Structural System Designer (PSD) software
- Motion system integration
- Deflection program
- Engineering quotes and drawings
- Quick quote software
- Assembly manuals
- Assemblies, kits and bundles

Parker IPS 138 Quadral Drive, Wadsworth, OH 44281

Customer: _____
 Customer No: _____
 Requestor: _____
 Phone: _____
 Fax: _____

Shipping Address: _____
 Billing Address: _____

Units Quoted: 1 USA

Comments: _____

Part Number	Qty	Length	UOM	Description	Mat. Code	Tap	Flts	Flts	UOM	Unit Price	Line Price	Sub Price	Unit Price	Line Price	Sub Price	Total Qty	Status
1	1	100.0	mm	IPS 100MM X 50MM ALUM	1					100.00	100.00	100.00	100.00	100.00	100.00	1	
2	1	100.0	mm	IPS 100MM X 50MM ALUM	1					100.00	100.00	100.00	100.00	100.00	100.00	1	
3	1	100.0	mm	IPS 100MM X 50MM ALUM	1					100.00	100.00	100.00	100.00	100.00	100.00	1	
4	1	100.0	mm	IPS 100MM X 50MM ALUM	1					100.00	100.00	100.00	100.00	100.00	100.00	1	
5	1	100.0	mm	IPS 100MM X 50MM ALUM	1					100.00	100.00	100.00	100.00	100.00	100.00	1	
6	1	100.0	mm	IPS 100MM X 50MM ALUM	1					100.00	100.00	100.00	100.00	100.00	100.00	1	
7	1	100.0	mm	IPS 100MM X 50MM ALUM	1					100.00	100.00	100.00	100.00	100.00	100.00	1	
8	1	100.0	mm	IPS 100MM X 50MM ALUM	1					100.00	100.00	100.00	100.00	100.00	100.00	1	
9	1	100.0	mm	IPS 100MM X 50MM ALUM	1					100.00	100.00	100.00	100.00	100.00	100.00	1	
10	1	100.0	mm	IPS 100MM X 50MM ALUM	1					100.00	100.00	100.00	100.00	100.00	100.00	1	
11	1	100.0	mm	IPS 100MM X 50MM ALUM	1					100.00	100.00	100.00	100.00	100.00	100.00	1	
12	1	100.0	mm	IPS 100MM X 50MM ALUM	1					100.00	100.00	100.00	100.00	100.00	100.00	1	
13	1	100.0	mm	IPS 100MM X 50MM ALUM	1					100.00	100.00	100.00	100.00	100.00	100.00	1	
14	1	100.0	mm	IPS 100MM X 50MM ALUM	1					100.00	100.00	100.00	100.00	100.00	100.00	1	
15	1	100.0	mm	IPS 100MM X 50MM ALUM	1					100.00	100.00	100.00	100.00	100.00	100.00	1	
16	1	100.0	mm	IPS 100MM X 50MM ALUM	1					100.00	100.00	100.00	100.00	100.00	100.00	1	
17	1	100.0	mm	IPS 100MM X 50MM ALUM	1					100.00	100.00	100.00	100.00	100.00	100.00	1	
18	1	100.0	mm	IPS 100MM X 50MM ALUM	1					100.00	100.00	100.00	100.00	100.00	100.00	1	
19	1	100.0	mm	IPS 100MM X 50MM ALUM	1					100.00	100.00	100.00	100.00	100.00	100.00	1	
20	1	100.0	mm	IPS 100MM X 50MM ALUM	1					100.00	100.00	100.00	100.00	100.00	100.00	1	
21	1	100.0	mm	IPS 100MM X 50MM ALUM	1					100.00	100.00	100.00	100.00	100.00	100.00	1	
22	1	100.0	mm	IPS 100MM X 50MM ALUM	1					100.00	100.00	100.00	100.00	100.00	100.00	1	
23	1	100.0	mm	IPS 100MM X 50MM ALUM	1					100.00	100.00	100.00	100.00	100.00	100.00	1	
24	1	100.0	mm	IPS 100MM X 50MM ALUM	1					100.00	100.00	100.00	100.00	100.00	100.00	1	
25	1	100.0	mm	IPS 100MM X 50MM ALUM	1					100.00	100.00	100.00	100.00	100.00	100.00	1	
26	1	100.0	mm	IPS 100MM X 50MM ALUM	1					100.00	100.00	100.00	100.00	100.00	100.00	1	
27	1	100.0	mm	IPS 100MM X 50MM ALUM	1					100.00	100.00	100.00	100.00	100.00	100.00	1	
28	1	100.0	mm	IPS 100MM X 50MM ALUM	1					100.00	100.00	100.00	100.00	100.00	100.00	1	
29	1	100.0	mm	IPS 100MM X 50MM ALUM	1					100.00	100.00	100.00	100.00	100.00	100.00	1	
30	1	100.0	mm	IPS 100MM X 50MM ALUM	1					100.00	100.00	100.00	100.00	100.00	100.00	1	

Internal Version 4.2
 Copy of Internal Quick Quote v4.2
 1 of 1

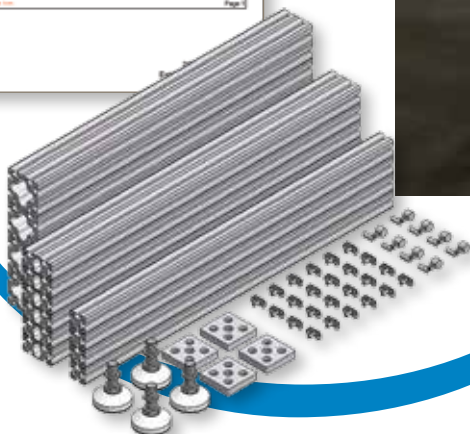

Build Smart with T-Slot Aluminum Framing

Parker IPS materials can create an unlimited variety of machine bases and frames, linear-slide systems, safety guarding, enclosures, worktables, material handling systems, and other industrial structures. Innovative customers use our IPS technology as the foundation for systems that feature industry-leading Parker motion control solutions.

Think Aluminum

Aluminum framing offers numerous benefits over typical welded steel fabrication.

- **Extremely short turnaround time from design to completion**
- **No welding, grinding, cleaning, painting, or distortions**
- **Eliminates costly traditional manufacturing processes**
- **Flexibility to re-configure as requirements change**
- **Lighter**

Profiles

Parker offers a comprehensive offering of metric and inch based profiles:

- **100+ individual high-strength aluminum profiles**
- **All structural profiles are aircraft grade, high strength, mill-certified with metallurgical properties of 6105-T5**
- **Aesthetically appealing extrusions offer best-in-class rigidity, durability, and hardness**
- **Unique T-slot design for reliable connection and easy modification**
- **Metric sizes range from 20 mm to 160 mm; inch sizes range from 1" to 6"**
- **Extensive range of smooth, grooveless profiles**



Lean Solutions

- **Improve your Quality and Lean journey**
- **Tracking and Communication, Day by the Hour boards and more!**
- **Pre-configured, standard part numbers**

Fasteners & Accessories

- **T-slots, end caps, fasteners, and covers**
- **Gussets, plates and brackets**
- **Handles and hinges**
- **Panels, sliding doors and gate hardware**
- **Feet and casters**
- **Work station accessories**
- **Slide blocks and bushings**
- **Rollers and slide bearings**
- **Belt and pulley assemblies**



Panels and Wire Mesh

Panels and wire mesh are available in full sheets or to specified cut-to-size dimensions. Standard panel choices include:

- **Lexan®**
- **Trespa®**
- **Expanded PVC**
- **PVC coated wire mesh**
- **Aluminum composite**

Specialty panels of any material can be ordered for any project.

Machining Services

Standard machining options include cutting, tapping, drilling, and counter boring. Additional custom machining by our expert machinists ensure that your design is complete and to your exact requirements.

Choose What Suits Your Needs

Choose a level of service to suit your needs from a completely assembled structure to a bundle of uncut profiles:

Assemblies



Parker IPS offers complete assembled solutions that are designed, custom fabricated, and shipped in as little as seven business days. (Lead times may vary and are application dependent.)

Kits



Profiles are cut and machined to order, fasteners and accessories are included based on a parts list, and the entire order is packaged and shipped for final assembly at your location.

Bundles



Our entire product line can be ordered as bundles of uncut or cut-to-length profiles, with packages of fasteners and accessories.

ing Components

Profiles

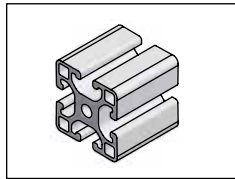

40, 30, 28, 20 Series
Metric

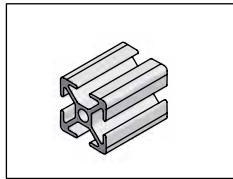

1.5", 1" Series
English



1/4 Round Profiles
30, 40, 1.5" Series

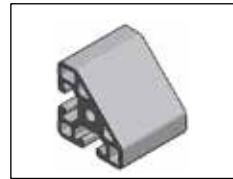

Angled Profiles
28, 40 Series

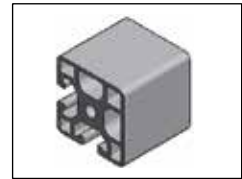

Closed Face Profiles
40, 30, 28, 20, 1.5" Series



Radius Profiles
40 Series

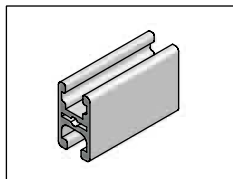

32x18 Frame Profile

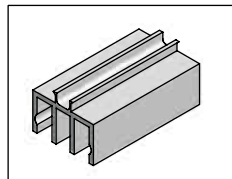

Door Guide Profiles

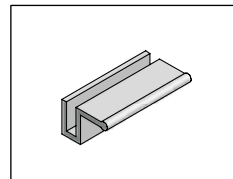

Panel Profiles

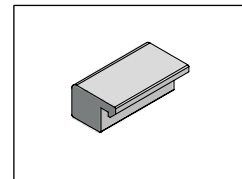

Clamp Profiles

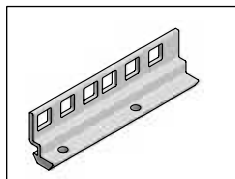

Rack Angle Profiles

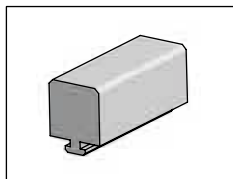

UHMW Profiles

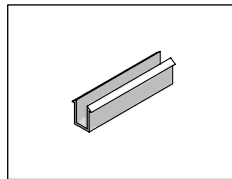

Gaskets,
Profile Covers

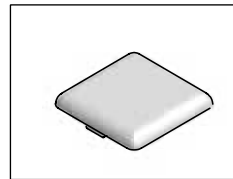

End Caps

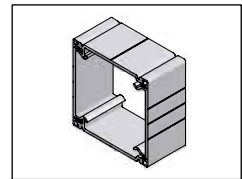

Conduit Profiles

Fasteners

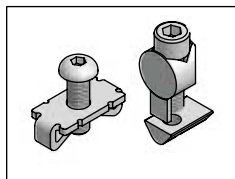

Fasteners

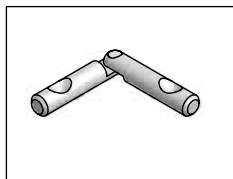

Miter Connectors

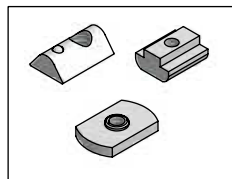

T-Nuts

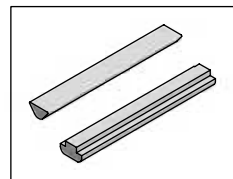

T-Slot Bars



Anodize Breaker

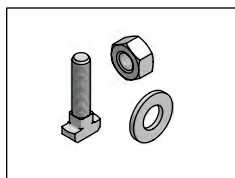

Bolts, Nuts
& Washers

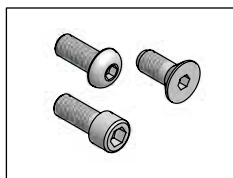

Screws

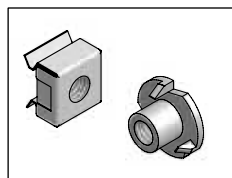

Clip & High Cycle
Nuts

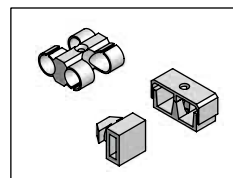

T-Clips &
Cable Holders

Modular Framing Components

Brackets, Gussets & Plates

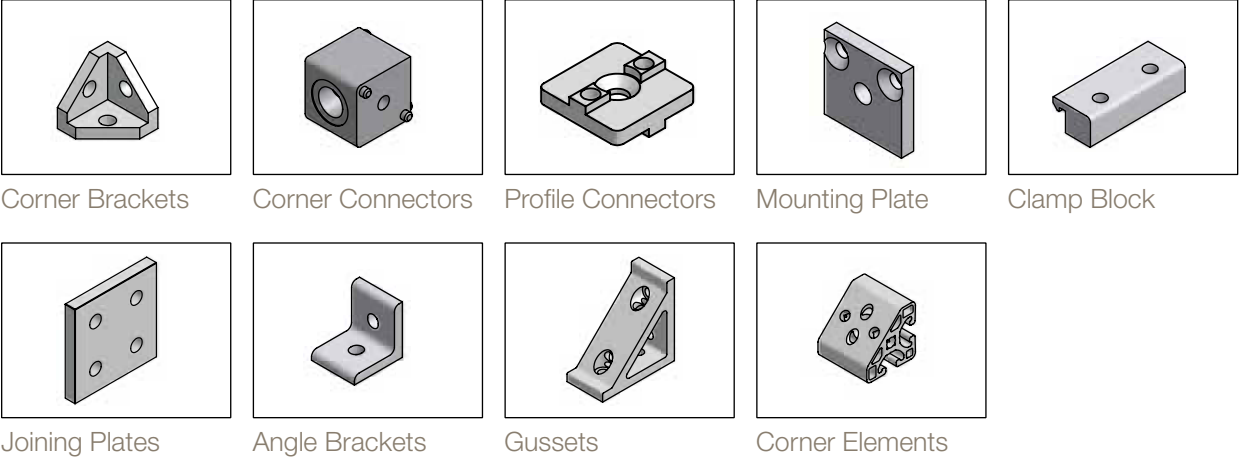

Panels & Doors

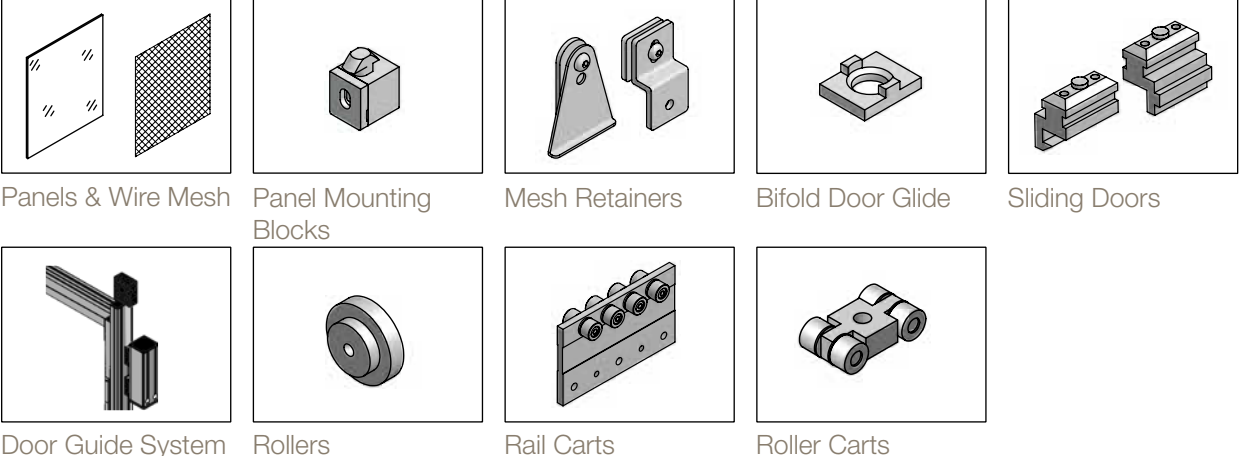

Handles, Hinges & Safety Switches

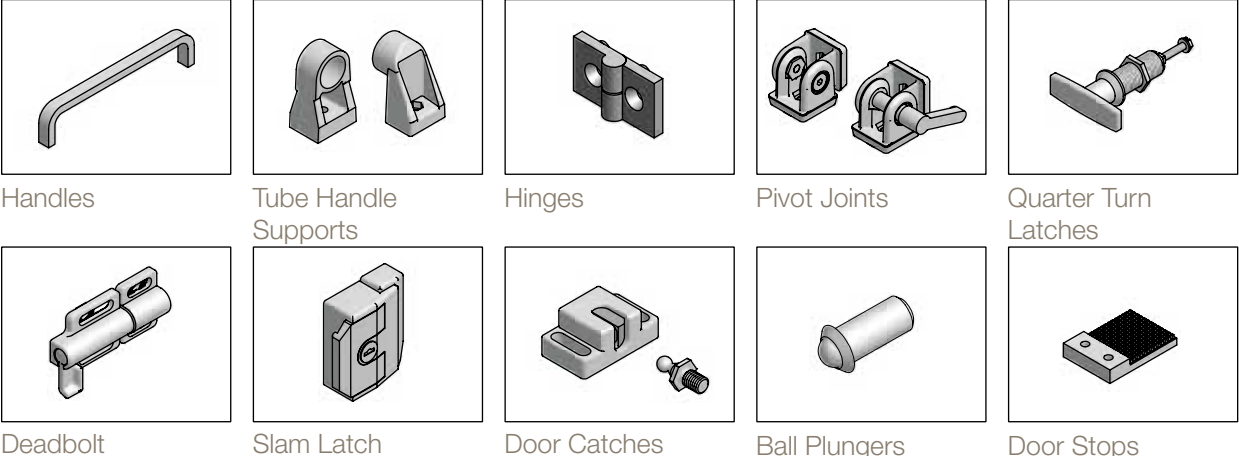

Feet & Casters

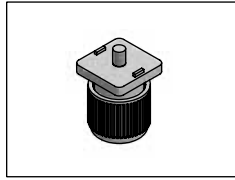

Leveling Feet

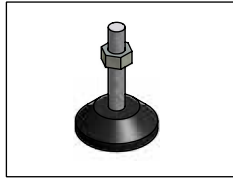

Knuckle Feet

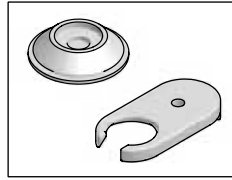

Foot Accessories

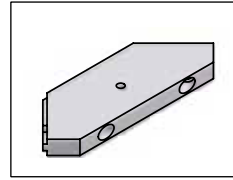

Corner Mounting Plate

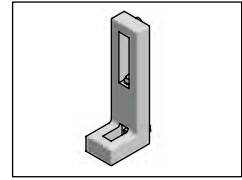

L-Base Leveler/Anchor

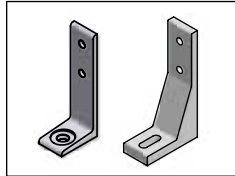

Floor Brackets

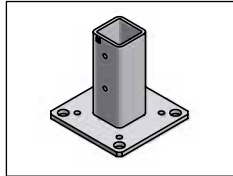

Flange Feet

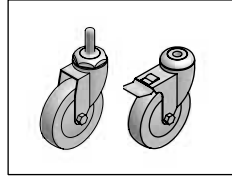

Casters

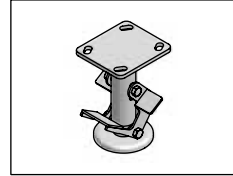

Floor Lock

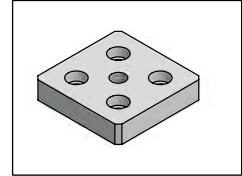

Base Plates

Pre-Designed Solutions

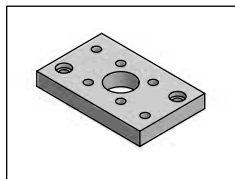

Pneumatic Plates

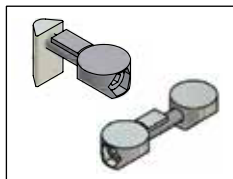

Pneumatic Fasteners

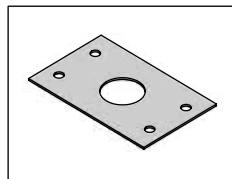

Pneumatic Seals

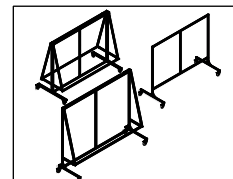

Tracking and Communication Stands

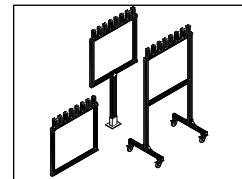

Day by Hour Stands



Lift Systems

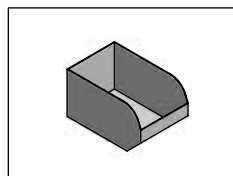

Workstations

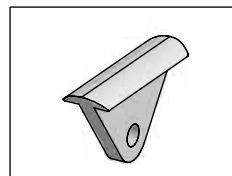

Tool Runners

Linear Applications

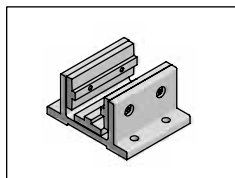

Slide Blocks

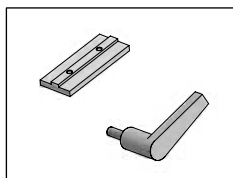

Block Accessories

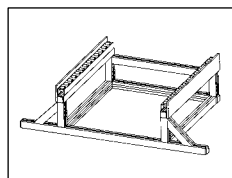

Roller Track

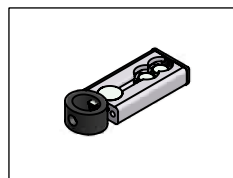

System Components

Services, Assembly Tips & Tools

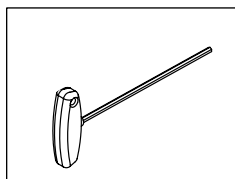

Tools

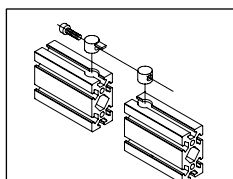

Machining Services

Complete Design Solutions

For the factory floor...



...& the front office!



***Put our Product, Market
& Application Experience
To Work for You***

IPS Solutions at Work:

Cardboard Storage

Before...



A valve manufacturing plant was looking to update their cardboard storage area. Throughout the day the shippers had to do a lot of bending and other tasks that were not ergonomically friendly.

After...



The valve manufacturer was able to use IPS to make the cardboard storage area more visually aesthetic, modular and ergonomically friendly. *This contributed to approximately 125,000 sq. ft. of reclaimed manufacturing floor space!*

Maintenance Workstations

Before...



This Maintenance Department was in need of a way to organize tools and make them accessible. They also needed a dedicated work area that was clear of clutter, in which to work.

After...



By using Parker's T-Slot Aluminum Framing to revamp the maintenance area, the Maintenance Department was able to have a modular and more organized work space. *This improvement added to the overall plant productivity by roughly 14%.*

Steel Enclosure Replacement

Before...



A customer in the paper industry was looking to retrofit the steel enclosures around their machines. Steel has its benefits, but from a weight, modularity and flexibility standpoint, the customer felt it was time to upgrade and came to Parker IPS for assistance.

After...



With the Parker IPS redesign, the customer was able to completely retrofit the heavy steel framing with light weight, but equally strong and durable aluminum. Pneumatic cylinders replaced the hydraulic cylinders to lift the enclosures, resulting in an added cost reduction. The line of sight for the machines was also greatly improved adding to the success of the plant upgrade.

Other Products from Parker...



Electromechanical Solutions

HMI and Controllers



Superior integration and support for machine control as well as HMI hardware and software.

www.parkermotion.com/globalpac

Or go to:

www.parkermotion.com/hmi

Electric Actuators



Screw, belt-driven, and linear motor actuators for the complete range of industrial applications, offering precise motion and flexibility.

www.parkermotion.com/eth

Motors and Drives



Parker's family of innovative servo/stepper motors and drives continues to expand to meet the challenges of new technologies.

www.parkermotion.com/ipa

Or go to:

www.parkermotion.com/motor

Gearheads



Parker offers a full line of in-line and right angle planetary gearheads, multi-drive NEMA gearheads, and integral gearmotors.

www.parker.com/gearheads

Pneumatic Solutions

Linear Actuator



Aluminum and steel pneumatic cylinders, guided cylinders, rodless cylinders, and short stroke thrusters from the industry leader.

www.parker.com/pneu/linear

Rotary Actuators



Industry leader in the design and manufacture of pneumatic rack and pinion, and vane-style rotary actuators.

www.parker.com/pneu/rotary

Vacuum Products and Sensors



Vacuum solutions include a broad range of generators (integrated/inline), cups, and pressure sensors.

www.parker.com/pneu/vacsen

Grippers

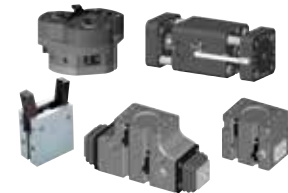

Parallel, angular, and three jaw grippers are available in over 1,000 configurations.

www.parker.com/pneu/grippers

Airline Accessories



Airline accessories include silencers, flow controls, and mufflers to round out Parker's pneumatic solution.

www.parker.com/pneu/accessories

Air Control Valves



Valve technology that meets the most demanding requirements in any industrial application.

www.parker.com/pneu/valve

Air Preparation



Parker, the industry leader in air preparation, offers a complete line of products to ensure clean, dry, oil-free air.

www.parker.com/pneu/airprep

Connectors and Tubing



The most complete line of fluid connectors worldwide will meet virtually any automation application.

www.parker.com/parflex

© 2015 Parker Hannifin Corporation

MFP
AUTOMATION
ENGINEERING



Parker Hannifin Corporation
Electromechanical Automation Div.

135 Quadral Drive
Wadsworth, OH 44281 USA
Tel: 800.333.4932 or 330-335-6740
Fax: 330.334.2350

Email: ipsquotes@parker.com or emn_support@parker.com

Print Date 1.15.15

5500 Business Park Drive
Rohnert Park, CA 94928
Tel: 800.358.9070
Fax: 707.584.8029