



aerospace
 climate control
 electromechanical
 filtration
 fluid & gas handling
 hydraulics
 pneumatics
 process control
 sealing & shielding



Hose, Fittings and Equipment

Catalog 4400 October 2011



HoseFinder^{2.0}
 Parker Hose Selection Guide



ENGINEERING YOUR SUCCESS.

Parker Hannifin – the global leader and your partner



With annual sales exceeding \$12 billion, Parker Hannifin is the world's leading diversified manufacturer of motion and control technologies and systems, providing precision-engineered solutions for a wide variety of mobile, industrial and aerospace markets. Our products are vital to virtually everything that moves or requires control, including the manufacture and processing of raw materials, durable goods, infrastructure development and all forms of transport.

Within Parker's eight operating groups, the company's engineering expertise spans the core motion technologies – electromechanical, hydraulic and pneumatic – with a full complement of fluid handling, filtration, sealing and shielding, climate control, process control and aerospace technologies.

The leader in “dry technology” for the fluid power industry, Parker's Fluid Connectors Group is your single source for high-quality tube fittings, hose and hose fittings, thermoplastic tubing, brass fittings and valves, quick-disconnect couplings and assembly tools. The Fluid Connectors Group serves customers in a broad range of markets, including Aerial Lift, Agriculture, Bulk Chemical Handling, Construction Machinery,

Food & Beverage, Fuel & Gas Delivery, Industrial Machinery, Medical, Mining, Mobile, Oil & Gas and Transportation. Products are available for shipment 24 hours a day, supported by 49 manufacturing facilities throughout the world, a global distribution network and 25 company-owned stocking service centers. Our commitment to you is impeccable customer service. To meet your specific requirements, we offer a broad range of programs designed to reduce your overall operating costs, streamline manufacturing, improve productivity, manage inventory, enhance delivery and address safety and environmental issues. For value-added services that generate value-added solutions, team up with Parker!



Low, Medium, High and Ultra Pressure Hose



Parkrimp® Permanent Hose Fittings



Parkrimp® Assembly Equipment



Field Attachable Fittings



HoseFinder^{2.0}
Parker Hose Selection Guide

Mobile Phone Applications

Hose Products Division



Parker Tracking System



ParkerStore™ Onsite Container Program



Custom Hose Assemblies and Hose Fittings



Accessories

With a long history of providing premier customer service, Hose Products Division is the leading manufacturer of hose, fittings and crimping technology for industrial and hydraulic markets. Continually expanding our products to better serve the market, we offer world-class service technologies including the Parker Tracking System, Onsite containers, rapid prototyping and smart phone applications. Our division headquarters in Wickliffe, Ohio, is our precision-engineered-solution center for products, materials and processes, and is equipped with state-of-the-art development, testing and performance technology. Hose Products Division has eight manufacturing locations within the United States dedicated to delivering a quality product on time. Knowing that uptime and productivity are major drivers in your business success, we proudly present our new catalog outlining Parker's best-in-class hose products and services.

Best regards,

Russ Kalis

General Manager

PARKER SAFETY GUIDE FOR SELECTING AND USING HOSE, TUBING, FITTINGS AND RELATED ACCESSORIES



WARNING

FAILURE OR IMPROPER SELECTION OR IMPROPER USE OF HOSE, TUBING, FITTINGS, ASSEMBLIES OR RELATED ACCESSORIES (“PRODUCTS”) CAN CAUSE DEATH, PERSONAL INJURY AND PROPERTY DAMAGE. POSSIBLE CONSEQUENCES OF FAILURE OR IMPROPER SELECTION OR IMPROPER USE OF THESE PRODUCTS INCLUDE BUT ARE NOT LIMITED TO:

- Fittings thrown off at high speed.
- High velocity fluid discharge.
- Explosion or burning of the conveyed fluid.
- Electrocutation from high voltage electric powerlines.
- Contact with suddenly moving or falling objects that are controlled by the conveyed fluid.
- Injections by high-pressure fluid discharge.
- Dangerously whipping hose.
- Contact with conveyed fluids that may be hot, cold, toxic or otherwise injurious.
- Sparking or explosion caused by static electricity buildup or other sources of electricity.
- Sparking or explosion while spraying paint or flammable liquids.

Before selecting or using any of these products, it is important that you read and follow the instructions below. Only hose from Parker's Stratoflex Products Division is approved for in flight aerospace applications, and no other hose can be used for such in flight applications.

Parker Publication No. 4400-B1 Revised 2007

DO NOT MIX & MATCH

DO NOT MIX & MATCH –

Components from different manufacturers should not be combined to create hose assemblies (apart from rare instances when both manufacturers have approved the exception). To mix and match components is to increase the risk of hose failure – a dangerous situation regardless of setting or application. Possible consequences of hose failure resulting from the use of incompatible components include:

- **Fittings thrown off at high speed**
- **High velocity fluid discharge**
- **Fluid injection injury**
- **Violently “whipping” hose**
- **Sparking or explosion from sprayed flammable fluids**
- **Suddenly moving / falling objects otherwise held static by fluid pressure**
- **Only assemble hoses and fittings of the same make**
- **Always use a crimper approved by the manufacturer of the hose and fittings**
- **Crimp only to the manufacturer's specification**

The individual is solely responsible for the hose assemblies he or she fabricates. Fluid power professionals should abide by three basic tenets when fabricating hose assemblies:

Parker's recommendations are consistent with SAE standard J1273: *Industry Consensus on Best Practices for Using Hydraulic Hose*. The complete technical paper, which includes SAE-recommended practices for hose assembly fabrication, can be purchased from www.SAE.org.

QR READER INTRODUCTION

You'll see QR tags throughout our catalog. These tags enable you to see additional product and other content on the web using your mobile device. You'll need a QR reader to get started. Please visit www.mobile-barcodes.com/qr-code-software for more information and a list of QR code readers you can install at no cost.



Table of contents

If you have questions about the products contained in this catalog, or their applications, please contact:

Hose Products Division
Phone: (440) 943-5700
Fax: (440) 943-3129
www.parkerhose.com

Extra care is taken in the preparation of this literature, but Parker is not responsible for any inadvertent typographical errors or omissions. Information is subject to change without notice. The information in this catalog is only accurate as of the date publication. For more current information, please visit **www.parkerhose.com**

Offer of Sale

The items described in this document are hereby offered for sale by Parker Hannifin Corporation, its subsidiaries or its authorized distributors. This offer and its acceptance are governed by the provisions in the "Offer of Sale."

www.parker.com/offersale

Hose

- Constant Working Pressure
- Hydraulic – Industry Standard
- Suction and Return
- Push-Lok®
- Phosphate Ester
- Low Temperature
- Transportation
- Alternative/Marine Fuel
- Refrigerant

A

Fittings

- Parkrimp (crimp)
- Field Attachable

B

Equipment

- Parkrimp Crimpers
- Die Selection Charts
- Pumps
- Hose Assembly Equipment

C

Accessories

- Flange Adapters and Kits
- O-Rings
- Hose Guards
- Clamps
- Workstations

D

Technical

- Size
- Temperature
- Application
- Media
- Pressure Information

- Part Number Index
- Safety Guide

E

Hose Products Division – the market leader and your supplier of choice.



Put a bite on the braid.

Parker's world-recognized tiger mascot has represented the Parkrimp No-Skive hose assembly program since its introduction in 1980. In a contest originally held by our marketing department, the tiger was the winning suggestion over three others: a turtle (deemed "too slow"), an alligator ("not very good looking") and a shark ("too intimidating" particularly at the time of the release of the movie Jaws).

More than three decades later, the tiger graphic still supports the Parkrimp message everywhere, clearly symbolizing our unique, patented Parkrimp fittings with tapered steel teeth and our Parkrimp crimping machines. Their ability to eliminate hose cover skiving and achieve the metal-to-metal grip of factory assemblies revolutionized the process for markets worldwide. And today, it's the industry standard.

Pride in our products: At Parker, we believe the best fluid connector products for your operation are the ones that get the job done right. We offer the most comprehensive line of hoses, fittings, equipment and accessories you'll need. And if there's something you need that's not a standard product, we're able to design and manufacture it for you with ease.

You'll also benefit from our ultimate competitive advantage – our network of distribution outlets that can provide our products nearly anytime and anywhere. We strive to provide customers with local engineering, local products and local service.

Parker offers the largest selection of hoses plus more fitting sizes than any other manufacturer. You'll find a wide variety of hoses including braided, spiral and multi-purpose, and more than 4,500 Parkrimp fittings. Parker products have been designed, tested and approved to meet and exceed global standards.



The right product is available for your application, including hose that features a variety of abrasion-resistant cover choices, flexibility, a wide range of media compatibility and more – characteristics that make Parker the hose supplier of choice for customers that demand the most from their equipment.



Made in the U.S.A. – serving the world.

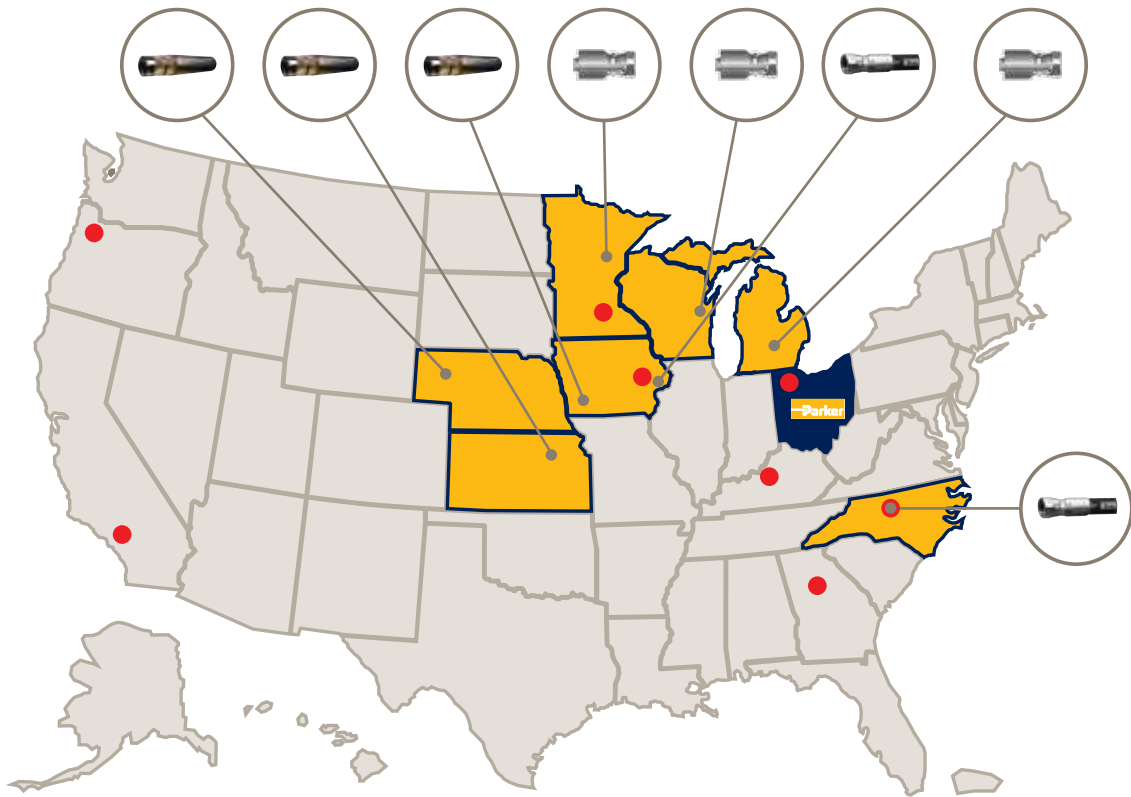

 Hose Manufacturing Plant	 Metal Manufacturing Plant	 Hose Assembly Facility	 Parker Service Center
--	---	--	---

CUSTOM FITTINGS



HOSE ASSEMBLY



TUBE ASSEMBLY & COMPOUND TUBE/HOSE ASSEMBLY



QUALITY

Being a solutions provider means helping our customers achieve higher levels of success by engineering the best systems for their requirements. It means looking at the customer applications from many angles to find new ways to create value.

Our customers define it, we deliver it.

Services – easy to do business with.



PARKER TRACKING SYSTEM (PTS)

PTS helps customers reduce equipment and machinery downtime by increasing the speed, timing and accuracy of acquiring replacements. Using our web-based application, PTS generates a unique identification code for each hose assembly which is printed on a durable barcode or RFID label.

PTS can eliminate costly hours of equipment downtime, helping customers achieve greater productivity and profitability.

www.parker.com/pts



HoseFinder^{2.0}
Parker Hose Selection Guide

MOBILE PHONE APP

Need a hose or fitting? We'll help you find it. Configure your selection by using Parker's STAMP process, or browse by category for thousands of hoses, fittings and accessories. It's like a catalog in your pocket, only better. How can something so powerful, be so small?

www.hosefinder.com



KITTING

Want to speed up assembly on the factory floor? Parker custom kits might be just what you're looking for. From fittings and adapters to pre-made assemblies, custom kits can hold a wide range of materials, in the exact order and quantities you need. What's the advantage? Streamlined procedures. Quicker assembly. Lower costs. And a single part number for easier processing.



VENDOR MANAGED INVENTORY

Enjoy a customized program where Parker personnel can manage your inventory in person or remotely. Reduce overall inventory, increase your inventory turns and increase your efficiency.



CAD

By making thousands of CAD files available, Parker provides its customers with the resources to do more.

Continuously developing ways to serve our customers.

CRIMPSOURCE™

The industry's most complete resource for crimper technical information, Crimpsource contains all of the crimp specifications approved for Parker's rubber, industrial and thermoplastic hose:

- **Crimp specs**
- **PDFs of technical manuals for easy downloading**
- **Parts lists**
- **Troubleshooting advice**
- **PDFs of crimper decals**

Crimpsource provides easy access to all of the specifications necessary to correctly fabricate a factory quality hose assembly. A series of drop down menus enables users to find what they need quickly and easily.

Choose your crimper, and then select the hose, fittings and current specifications needed to make hose assemblies. You can also print a simple-to-follow data specification sheet or crimper decal.

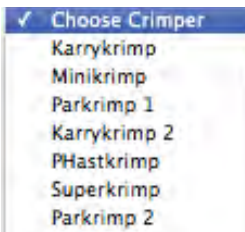

www.parker.com/crimpsource

BREADMAN

Lean logistics and delivery of Parker products and kits directly to the customer's assembly line, work station or warehouse.

- **100% parts availability minimizes downtime, increases production and reduces costs**
- **Elimination of stock checking reduces manpower and maintains production levels**
- **Daily delivery reduces inventory and overheads**
- **Electronic order processing eliminates paperwork and reduces administration costs**



Parker hose meets evolving industry specifications.

NEW Standard

International ISO Standard – many of our new hoses are designed to the ISO 18752 specification. This specification allows for the performance of the hose to dictate the grading it receives. Parker knows how tough hose applications can be, and we built our newest spiral hoses to withstand the toughest requirements ISO 18752 has to offer... and more.

Legacy

SAE hoses – pressure varies by size (R9, R10, R11, R12)

Newer

SAE hoses (R13, R15, R17, R19) are constant pressure

Future

ISO standard 18752

- Hose spec established in 2006
- Constant working pressure class hoses
- Differentiated performance levels
- Industry trend toward ISO specs

ISO 18752 Performance Definitions (Section 4.2 Grades and Types)

Hoses are classified according to their resistance to impulse into four grades: A, B, C and D. Each grade is classified by outside diameter into standard types (AS, BS and CS) and compact types (AC, BC, CC and DC), as shown in the table below.

Grades and Types				
Grade	Type ^a	Resistance to Impulse		
		Temperature °C	Impulse Pressure (% of MWP ^b)	Minimum Number of Cycles
A	AS	100	133%	200,000
	AC			
B	BS	100	133%	500,000
	BC			
C	CS	120	133% and 120% ^c	500,000
	CC			
D	DC	120	133%	1,000,000

^a Standard or compact, e.g. CS is grade C and standard type.
Standard types have larger outside diameters and larger bend radii and compact types have smaller outside diameters and smaller bend radii.

^b Maximum working pressure.

^c 120% of the MWP shall be used for classes 350, 420 and 560 instead of 133%.



ISO 18752 Pressure Classes

The ISO pressure class specification addresses the most demanding and highest performance applications.

Class		35	70	140	210	250	280	350	420	560
MWP ^a (bar)		35	70	140	210	250	280	350	420	560
MWP ^a (MPa)		3.5	7	14	21	25	28	35	42	56
MWP ^a (psi)		500	1000	2000	3000	3500	4000	5000	6000	8000
Nominal Size										
ISO	Inch									
5	-3	●	●	●	●	●	●	●	●	N/A
6.3	-4	●	●	●	●	●	●	●	●	N/A
8	-5	●	●	●	●	●	●	●	●	N/A
10	-6	●	●	●	●	●	●	●	●	N/A
12.5	-8	●	●	●	●	●	●	●	●	N/A
16	-10	●	●	●	●	●	●	●	●	●
19	-12	●	●	●	●	●	●	●	●	●
25	-16	●	●	●	●	●	●	●	●	●
31.5	-20	●	●	●	●	●	●	●	●	●
38	-24	●	●	●	●	●	●	●	●	N/A
51	-32	●	●	●	●	●	●	●	●	N/A
63	-40	●	●	N/A	N/A	N/A	N/A	N/A	N/A	N/A
76	-48	●	●	N/A	N/A	N/A	N/A	N/A	N/A	N/A
102	-64	●	N/A	N/A	N/A	N/A	N/A	N/A	N/A	N/A

Note: ● = Applicable N/A = Not Applicable ^a = Maximum Working Pressure

The Parker Tracking System (PTS)

Global asset tagging and identification system.



PTS helps customers reduce equipment and machinery downtime by increasing the speed, timing and accuracy of acquiring replacements. Using a web-based application, PTS generates a unique identification code for each hose assembly which is printed on a durable barcode or RFID label.

PTS equipment is easy to own and operate



PTS is an advanced global tagging and tracking solution already being deployed on OEM machinery and mobile equipment in dozens of countries.

PTS can eliminate hours of costly equipment downtime, helping customers achieve greater productivity and profitability.



The Parker Tracking System is a unique and valuable service available exclusively for Parker customers.

The Parker Tracking System (PTS) is a unique and valuable service available exclusively for Parker customers. PTS reduces vehicle or asset downtime by increasing the speed, timing and accuracy of necessary hose assembly replacements.

Using a secure Web-based application, PTS generates a unique identification code for each hose assembly which is printed on an ultra-durable barcode or RFID label. PTS labels are specifically engineered to withstand harsh chemicals, temperatures, UV exposure and other challenging conditions.

Why use PTS:

- Capture, record and recall unique hose assembly information – on demand.
- Receive fast and accurate product identification to speed replacement, regardless of where the original assembly was made.
- Hose assemblies can be replaced with only the PTS ID number, eliminating the need to remove hoses prior to replacement, providing critical machine uptime and enabling a more conveniently scheduled repair.
- Reporting tools assist in continuous improvement programs and preventative maintenance initiatives.

Save valuable time with PTS.

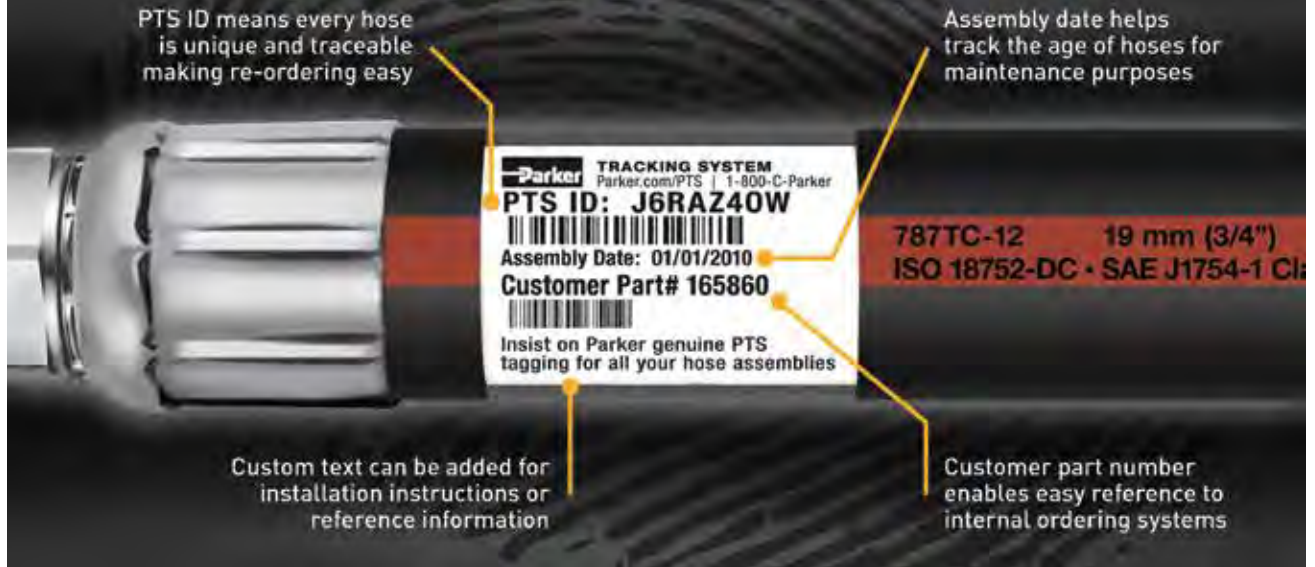

How PTS Works:

- PTS labels are customized with specific assembly information and attached to the hose when the assembly is made.
- When the assembly requires replacement, simply call your local distributor with your PTS number, or call 1-800-C-Parker to find an authorized distributor near you.
- The distributor can create an exact replacement of your hose assembly and either ship it to you or have it ready to pick up once you arrive. Distributors can also scan your hose label in-store.
- Data is collected about your failure which may help us in recommending different components or accessories designed to get the most from your machine or equipment.

PTS labels are specifically engineered to withstand harsh chemicals, temperatures, UV exposure and other challenging conditions.



The benefits of working with Parker Hose

Bring the power of Parker to the palm of your hand.



HoseFinder^{2.0}
Parker Hose Selection Guide

www.hosefinder.com

Parker is committed to delivering customer service options to help you work smarter, faster, and better.

Need the latest? Go online. From complete product information on hose, to 3D-CAD models of our complete fitting line, you'll find everything you need at www.parkerhose.com.

And HoseFinder, our mobile app, makes it fast and convenient to search for hydraulic hose products and information on the go. The app features an abbreviated STAMP selection process to help you find

what you need quickly and easily. Download yours today at www.hosefinder.com.

Whatever you do, visit our site often. It's the fastest and easiest way to keep up with changing technology and our ever expanding product offering.

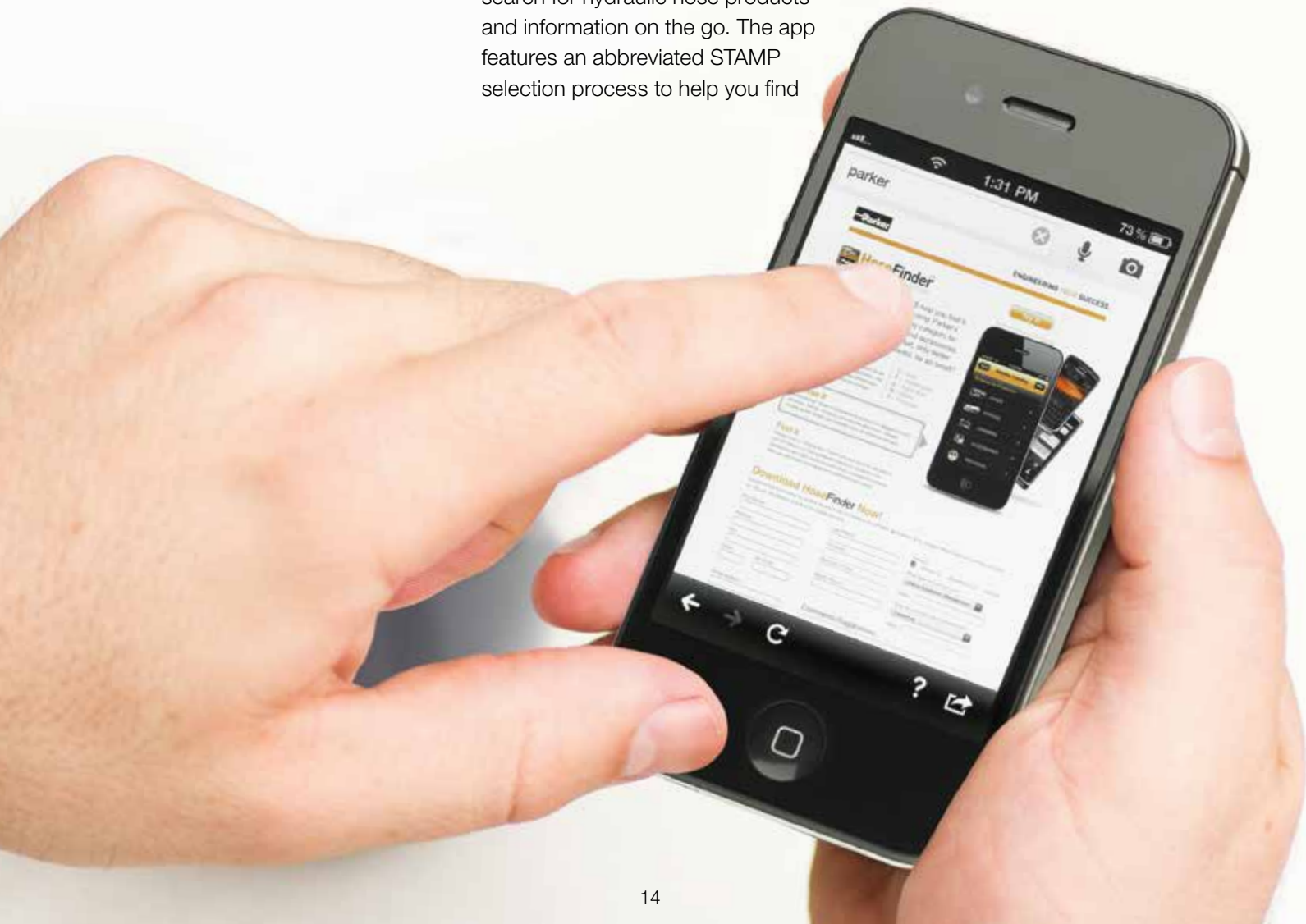



Configure your selection by using Parker's STAMP process, or browse by category for thousands of hoses, fittings and accessories.

- 1 Browse it.** It's easy to use.
- 2 STAMP it.** Use the STAMP search or browse the catalog to find the product you are looking for.
- 3 Search it.** Results include all the details you need to make an informed decision.
- 4 Find it.** Choose the "Find It" link and you'll be directed to one of Parker's 12,000 worldwide distributor locations.



Browse it.

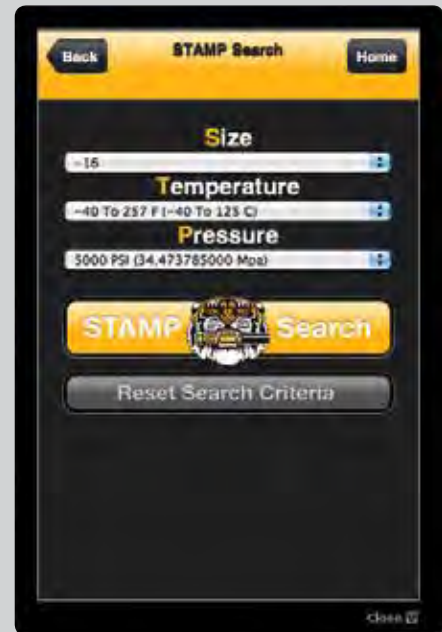

STAMP it.



Search it.

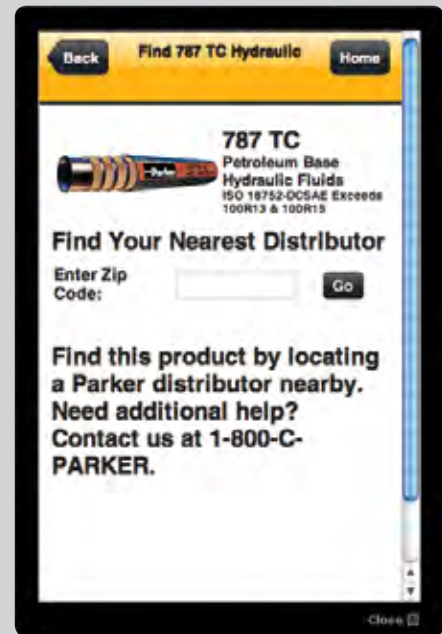

Find it.

HoseFinder is currently available for iPhone®, Blackberry® and Android™ mobile phones... and at no charge.

The Parker Fluid Connectors Group

Take advantage of our connections.

Need help with the big picture? Turn to Parker. As part of the Fluid Connectors Group, we have everything to keep the ideas flowing.

More products

Nobody offers you more than Parker. We have the largest selection of hose, more fitting sizes and configurations than any other manufacturer. Our products deliver the exceptional quality and reliability you've come to expect from us, meeting or exceeding market standards. Plus they're available in a wide choice of materials, designs, shapes, sizes, covers, and capabilities for your specific leak-free performance requirements.

But more parts are only part of what we offer you.



More people

Our 2,100 worldwide distributors give you more places to go for more help, faster. Which means when your equipment is down, we're there for you, right near the job site.

Nobody else can equal that kind of convenient service.

Mobile services

Parker is your best bet for on-the-job help. Our mobile services operate 24 hours a day, 7 days a week, to arrive at your plant or job site fast. Complete with factory-trained professionals to troubleshoot your problem. Our mobile vans carry a full complement of hose, all major fitting configurations, and a complete set of metrics — everything that's needed to create a replacement. It's like having your Parker distributor come to you! Find out more at parker.com/distributors.





ParkerStores

ParkerStores provide walk-in customers with the ability to personally select the parts they need in a retail environment. Customers can see, touch, and feel the parts they're considering, and talk directly to staff when advice is needed. With more than 1,800 locations in 75 countries, ParkerStores are yet another way customers can get in, get out, and get going.



ParkerStore Onsite mobile work containers

To provide expert service even in the most remote job site locations, the ParkerStore Onsite Program delivers a fully customized mobile workspace directly to your job site. These highly efficient and mobile container-based work sites provide all the technology, equipment and inventory needed for remote fabrication of hose and tube assemblies, and much more.

The ParkerStore Onsite container solution will significantly reduce the time it takes to obtain critical spares or fabricate replacement hose assemblies. Equipment and labor downtime are greatly reduced, keeping your operations up and running longer. Find out more at www.parker.com/onsite.

Your ParkerStore Onsite container can be personalized to meet your specific site or project needs.

		
Cargo Doors	Storage Racks and Cabinets	Full Electrical Service
		
Security Doors	Heating/Cooling	Rugged Lighting Service

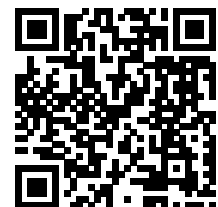

Parker testing facilities

Assuring superior quality and performance.



Multiple test capabilities and the latest testing technology combine to assure the integrity of Parker products globally.

Putting designs to the test, our world class development and test capabilities assure our customers of world-class quality and performance. In the field or in our advanced development and test facility, Parker is unsurpassed in both technical knowledge and testing capabilities. With the latest in technology, our state-of-the-art materials development and performance test labs are capable of determining baseline engineering and design properties. Additionally, we simulate application and environmental conditions encountered every day, both common and complex, assuring the integrity of Parker products designed to meet your needs.

Consistency in product performance starts with consistent materials. Parker's materials

development laboratory uses the latest technology in equipment and methods to evaluate the behaviors of elastomeric materials under varying conditions. Our in-house capability assures the materials in our design are engineered to withstand the extremes of application and the environment, time after time, every time.

With specialized skills, and time-tested experience, Parker engineers have built an impressive record of problem solving for our customers. We understand the importance of product selection, designed and tested to meet your unique demands. And our customers understand the value of our solutions.

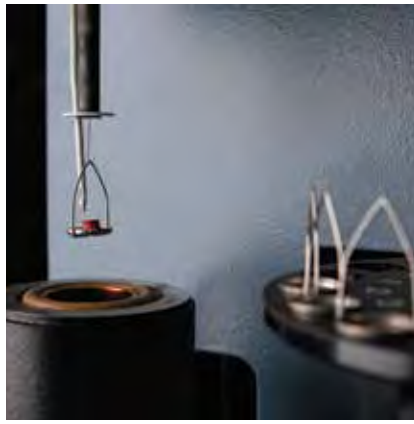

Thermogravimetric analyzer

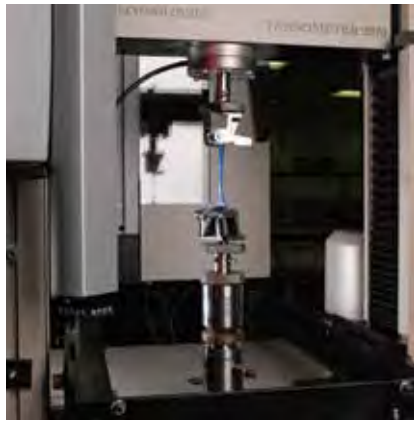

Tensometer



Soxhlet extraction



Salt spray test



Rubber mixing

Burst Pressure Test (*below*)
Using our state-of-the-art testing and performance technology in our precision-engineered-solutions center, we continuously look to better serve our customers by ever improving our products.



Before you spec it, STAMP it.

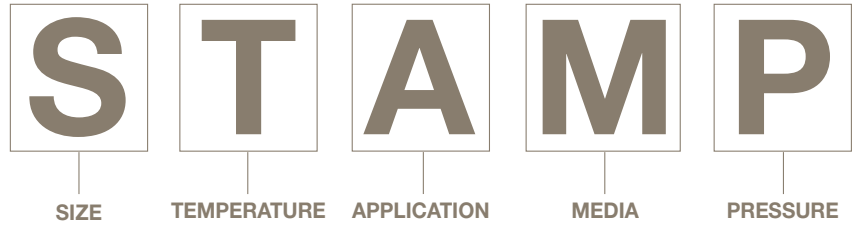

When you order hose and fittings from Parker, remember the word “STAMP.” That way you won’t forget important information!

Size

Parker uses a system of measurement called Dash Numbers to indicate hose and fitting size. The dash number, or dash size, is the measure of a hose’s Inner Diameter (I.D.) in sixteenths of an inch. (The exception to this is SAE 100R5 hose. See the chart below for complete details.)

diameter measured. Be sure to measure the overall assembly length and fitting orientation before cutting the hose.

The hose I.D. must be sized accurately to obtain the proper flow velocity. A flow that’s too slow results in sluggish system performance, while a flow that’s too high causes excessive pressure drops, system damage, and leaks.

Use the Flow Capacity Nomogram in Section E to determine the proper hose I.D. for an application’s flow rate requirements.

This measuring system of the inside diameter of the hose is universally used by the fluid power industry today. Don’t know the hose size? Check the layline. If the original printing has worn off, the original hose must be cut and the inside

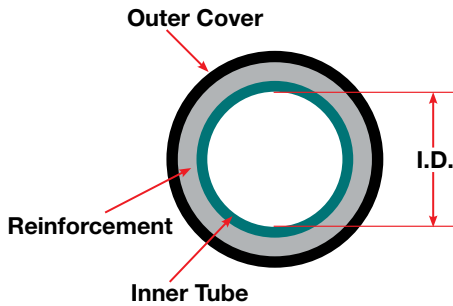

The hose size is determined by the inside diameter which can be measured or found on the layline.

Dash No.	Hose I.D. (Inches)			
	All Except Transportation and Refrigerant Hoses		Transportation and Refrigerant Hoses	
	Inches	Millimeters	Inches	Millimeters
-3	3/16	5	–	–
-4	1/4	6,3	3/16	5
-5	5/16	8	1/4	6,3
-6	3/8	10	5/16	8
-8	1/2	12,5	13/32	10
-10	5/8	16	1/2	12,5
-12	3/4	19	5/8	16
-16	1	25	7/8	22
-20	1-1/4	31,5	1-1/8	29
-24	1-1/2	38	1-3/8	35
-32	2	51	1-13/16	46
-40	2-1/2	63	2-3/8	60
-48	–	–	3	76



Temperature



When specifying hose, there are two temperatures you need to identify. One is the **ambient temperature**, which is the temperature that exists outside the hose where it is being used; the other is the **media temperature**, which is the temperature of the media conveyed through the hose.

Very high or low ambient temperatures can have adverse effects on the hose cover and reinforcement materials, resulting in reduced service life.

Media temperatures can have a much greater impact on hose life. For example, rubber loses flexibility if operated at high temperatures for extended periods.



Parker hoses carry different temperature ratings for different fluids. For example, 811HT hose has a temperature range of -40°F to +257°F (-40°C to +125°C) for petroleum-based hydraulic fluids. However for water, water/glycol, and water/oil emulsion hydraulic fluids, the range drops to a rating of up to +185°F (+85°C). Air is rated even lower at up to 158°F (+70°C).

Some media can increase or decrease the effects of temperature on the hose. The maximum rated temperature of a hose is specific to the media. See the Minimum/Maximum Temperature Chart in Section E for a full listing of all temperature ratings.



Parker offers a wide range of special types of hoses for low and high temperatures. See pages A-6 to A-7 Hose Overview.

Application

Before selecting a hose, it is important to consider how the hose assembly will be used. Answering the following questions may help:

- **What type of equipment is involved?**
- **What are the environmental factors?**
- **Are mechanical loads applied to the assembly?**
- **Will the routing be confined?**
- **What about hose fittings – permanent or field attachable?**
- **Will the assembly be subjected to abrasion?**

Sometimes specific applications require specific hoses. For example, applications where hoses will encounter rubbing or abrasive surfaces, would be best handled by our family of abrasion-resistant hose with both Tough and Super Tough covers.

When application space is tight, bend radius is another important consideration. Parker offers a full line of hoses designed for one-half SAE bend radius at full SAE-rated pressures. We offer hoses with increased flexibility and smaller outer diameters enabling faster, easier routing in small spaces, reducing both hose length and inventory requirements.

Industry standards set specific requirements concerning construction type, size, tolerances, burst pressure, and impulse cycles of hoses. Parker hydraulic hoses meet or exceed standards such as:

- **SAE (Society of Automotive Engineers)**
- **EN (European Norm)**
- **DIN (Deutsches Institut für Normung)**
- **ISO (International Organization for Standardization)**

Hose Hint

When considering the bend radius of a hose assembly, a minimum straight length of twice the hose's outside diameter should be allowed between the hose fitting and the point at which the bend starts.



**Compact Spiral™ 797TC-12
has 1/2 the
Bend Radius**

10-1/2"



Governmental agencies control additional standards for particular industries such as U.S.C.G. and ABS. You must select a hose that meets the legal requirements as well as the functional requirements of the application.

Hose Hint

A hose assembly should be routed so that the hose is not stretched, compressed, or kinked to assure maximum service life and safety.



Compact Spiral™ Bend Radius

Not only is it **1/2 the bend radius**, but it takes **1/3 less effort** to bend.

SAE 100R15

21"

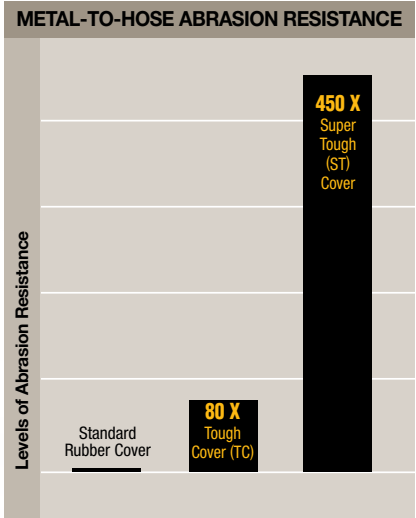

Results from the ISO 6945 metal-to-hose abrasion test show that Tough Cover and Super Tough cover hoses offer significantly greater abrasion resistance than standard rubber cover hose.

Catalog 4400 US Technical

Media Chemical Resistance Information

Warning: Selection of products, fluid, and/or use of these materials must be done carefully to ensure proper compatibility. Consult the Chemical Resistance Chart for more information.

Media	1	2	3	4	5	6	7	8	9	10	11	12	13	14	15	16	17	18	19	20	21	22	23	24	25	26	27	28	29	30	31	32	33	34	35	36	37	38	39	40	41	42	43	44	45	46	47	48	49	50
Water	1	2	3	4	5	6	7	8	9	10	11	12	13	14	15	16	17	18	19	20	21	22	23	24	25	26	27	28	29	30	31	32	33	34	35	36	37	38	39	40	41	42	43	44	45	46	47	48	49	50

Parker

Media

What will the hose convey?
Some applications require the use of specialized oils or chemicals. The hose you order must be compatible with the medium being conveyed. Compatibility must cover the inner tube, the cover, hose fittings, and o-rings as well. Use the

Chemical Resistance Chart found in Section E to select the correct components of the hose assembly that will be compatible with your system's media. The chart contains the chemical resistance rating of a variety of fluids.



Hose Hint

For long service life and leak-free functionality, it is vital that the hose assembly be chemically compatible with both the fluid being conveyed through the hose as well as the environment of the hose.

Pressure

When considering hose pressure, it's important to know both the system working pressure and any surge pressures and spikes.

Hose selection must be made so that the published maximum working pressure of the hose is equal to or greater than the maximum system pressure. Surge pressures or peak transient pressures in the system must be below the published maximum working pressure for the hose.

Each Parker hose has a pressure rating which can be found on the Hose Overview Chart on page A-6, to A-7 and in Section E.

All Parker hydraulic hoses have passed the industry rated specifications for burst pressure and carry a 4:1 design factor unless otherwise noted. Burst pressure ratings for hose are for manufacturing test purposes only. They are not an indication that the product can be used above the published maximum working pressure. It is for this reason that the burst pressure ratings have been removed from the hose charts within the catalog.

Care must also be taken when looking at the “weakest link” of the hose assembly. A hose assembly is rated at the maximum working pressure of the hose and the fitting component. Therefore the maximum working pressure of the hose assembly is the lesser of the rated



To mix and match components is to increase the risk of hose failure – a dangerous situation regardless of setting or application.

working pressure of the hose and the end connections used.

Here is an example: An F471TC0101040404-60” hose assembly (which consists of 471TC-4 hose and two 10143-4-4 fittings) would have a maximum working pressure of the lesser of the three components. In this case the fittings have a 12,000 psi rating. The hose has a 5,800 psi rating. Therefore the maximum pressure rating of the hose assembly would be 5,800 psi. Pressure ratings for each Parker end connection can be found on the Pressure Rating of Hose End Connections – PSI Chart in Section E.

Pressure spikes can occur during machine operation in an instant. They can occur so quickly in fact, that standard glycerin filled gages will never detect them. Using a pressure diagnostic system like Parker's Senso Control can help detect how often and how drastic these pressure spikes are. Contact your Parker representative today.

Hose Overview page A-6 to A-7.

Pressure Rating of Hose End Connections page E-43.



Hose basics

Everything you need to know.

Hose Hint

Use the layline of the hose as a visual index when routing and tightening the assembly to ensure the hose is not twisted or kinked.

It's all in the family

At Parker, we believe the best hose for your operation is the one that gets the job done right — no more, no less. That's why we offer you a comprehensive line of hoses, as well as all the options that go with it. Worried about price?

Abrasion?

We've got you covered

Our expanded line of abrasion-resistant hose offers you a world of protection, not to mention a choice of covers: Tough Cover (TC) for tough environments; and SuperTough (ST) for the really rough stuff.

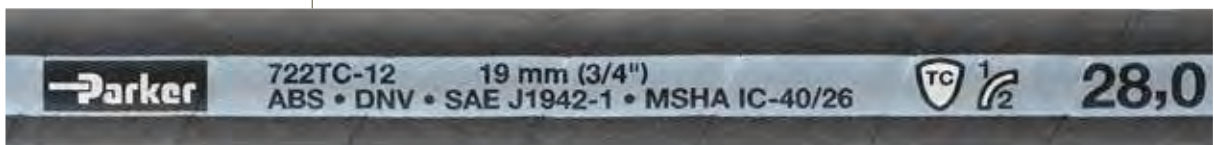



We've got rubber hoses that are an exceptional value. Need hose that can take the heat? We've designed hoses for that. Looking for hose to handle the most demanding conditions? No problem. We have hoses made specifically for high temperatures, tight bending, abrasive environments, and more.

Not sure what hose you need? Talk to our experts. They're trained to know, and they're happy to help.

Our TC- and ST-covered hoses can simplify your assemblies by eliminating the need for any additional protective sleeving.

From the superior flexibility and tighter bend radius of our wire-braided hoses... to the wide fluid compatibility and high pressure performance of our No-Skive spiral hoses... our expanded family of abrasion-resistant hoses gets the job done right, giving you the results you need in the construction, forestry, mining, injection molding, refuse and recycling, and energy industries.

Metal-to-Hose Abrasion Resistance Comparison	
Levels of Abrasion Resistance	Results from the ISO 6945 metal-to-hose abrasion test show that Tough Cover and Super Tough cover hoses offer significantly greater abrasion resistance than standard rubber cover hose.
	<div style="border: 1px solid black; padding: 2px; display: inline-block;">Standard Rubber Cover</div> <div style="border: 1px solid black; padding: 2px; display: inline-block; margin-left: 20px;">80 X Tough Cover (TC)</div> <div style="border: 1px solid black; padding: 2px; display: inline-block; margin-left: 20px;">450 X Super Tough (ST) Cover</div>

Optional Covers	
Type	Features
Tough Cover (TC) 	Very good abrasion resistance. Fair resistance to ozone and cold flexibility.
Super Tough (ST) 	Excellent abrasion resistance. Very good resistance to ozone and cold flexibility.

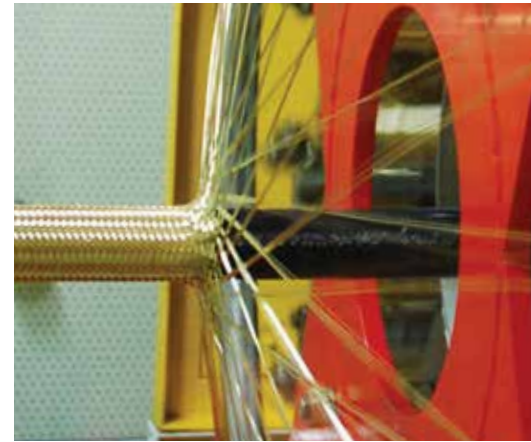
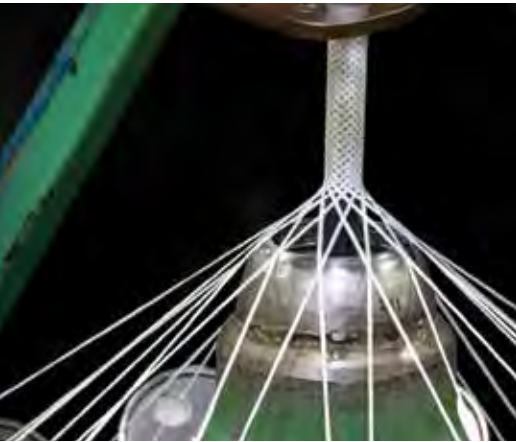

Braided vs. spiral hose

Hydraulic hose can be referred to by construction style, of which there are two main types: braided and spiral. The majority of “low-pressure hoses” have a textile braided construction. They’re commonly used to transmit petroleum-based fluids, diesel fuel, hot lubricating oil, air, ethylene glycol anti-freeze, and water.

“Medium-pressure hoses” typically feature one- and two-wire braided construction. These hoses are frequently found on construction equipment, heavy-duty trucks, and fleet vehicle applications. In general, braided hose is selected for its flexibility.

At one time in the industry, two-wire braided hose was most commonly used in many applications. But the advent of larger, off-road specialty equipment drove the creation of spiral hose, which is very well suited for applications where extremely high impulse pressure is encountered.

Today, hydrostatic drives using four and six-wire spiral hoses can be found on everything from lawn tractors to earth movers. Because today’s world demands faster, more powerful equipment requiring increased working pressures, Parker is responding with an expansive offering of spiral products.

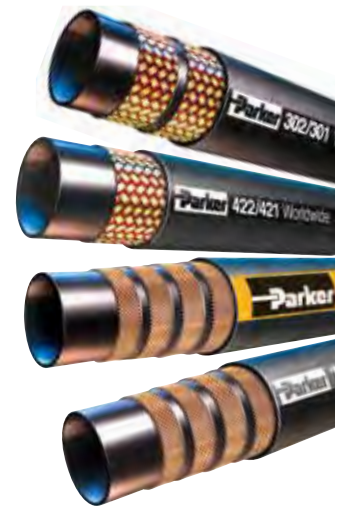

Contact your local Parker distributor to see the full range of hose choices, and to discuss their various applications.

Inner beauty

The inner tube of a hose is offered in several different rubber compounds. Each rubber compound can react differently to the media being conveyed. The inner tube must also resist effects of high or low temperatures and environmental elements. The table on the right highlights popular rubber compounds used for hose inner tubes:

Inner Tube Compounds	
Type	Features
PKR® Rubber	Excellent resistance to ozone and weathering; good heat resistance. Good resistance to petroleum-based fluids.
Synthetic Rubber	Excellent resistance to petroleum-based fluids and environmentally friendly fluids.
Butyl Rubber	Very good weathering resistance. Good physical properties. Poor resistance to petroleum-based fluids.
EPDM Rubber	Excellent resistance to phosphate ester fluids and dry air. Poor resistance to petroleum-based fluids.

Strong like spiral bends like braided

Looking for flexible hose that can be routed in tight spaces?

Parker has a full line of hoses designed for one-half SAE bend radius at full SAE pressure. These hoses plumb and bend tighter than other SAE 100R1, 100R2,

100R4, 100R12 and 100R13 type hoses, reducing hose length requirements by up to 47%. The tighter bend radius means fewer bent tube fittings, and longer life in applications where machinery movement causes hoses to bend sharply. It also means reduced inventory requirements for you.

Compact Spiral Hose has half the bend radius of its SAE counterpart and a significantly smaller bend radius than corresponding-size Parker conventional spiral hose.

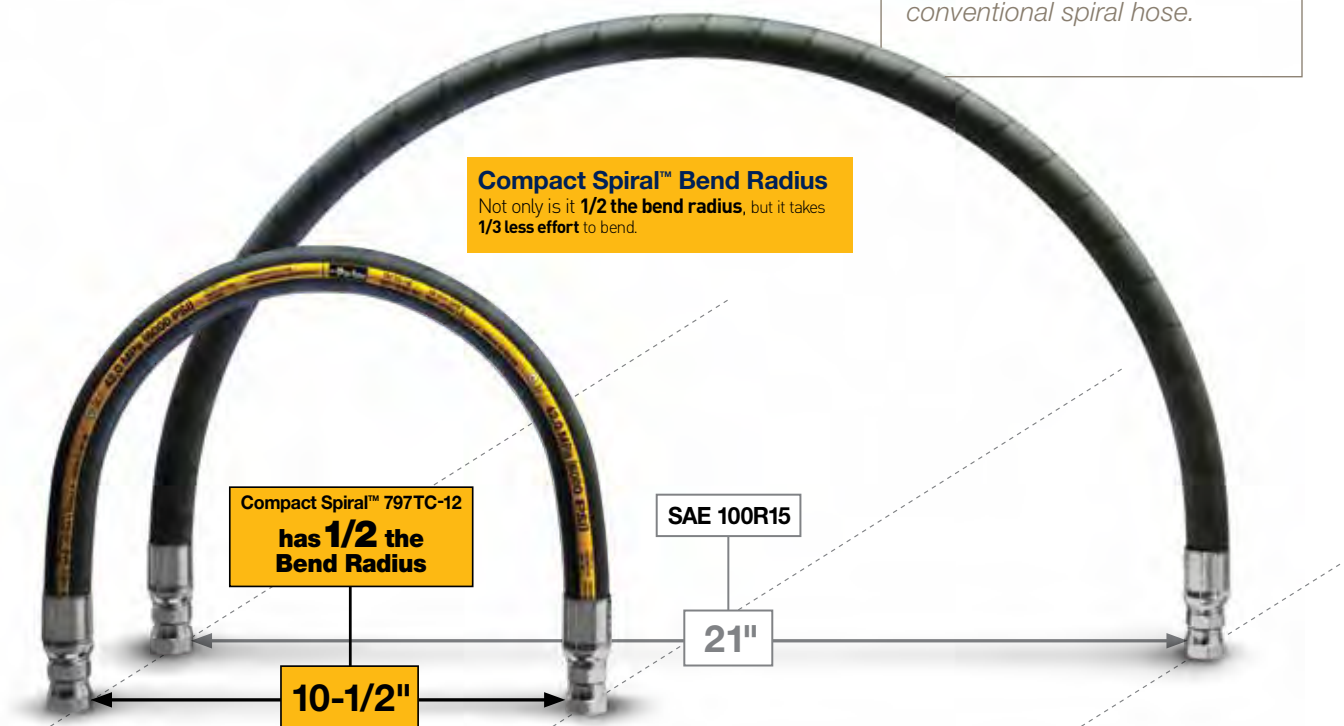

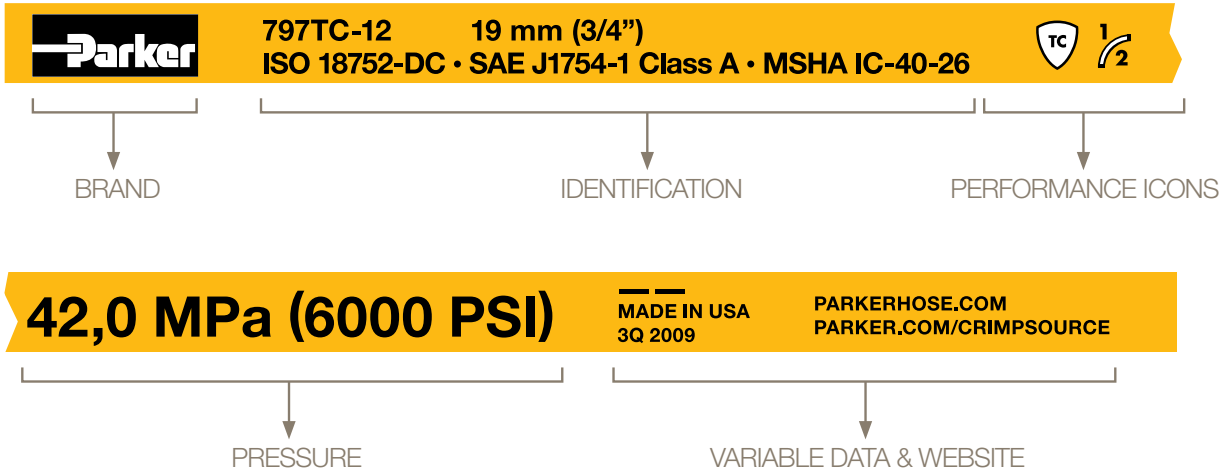







Our layline is easier to read

Our new layline presents the most important information in an easier to read format. And the performance icons make it easier to identify what elements pertain to that hose.

The layline, or printing along the length of a hose, contains a wealth of useful information about that product. Inside diameter, maximum working pressure, part number, industry standards that the hose meets, and even manufacturing date are among the information supplied.

PERFORMANCE LEGEND

					
Half SAE Bend	Tough Cover	SuperTough Cover	High Temperature	Low Temperature	Compact

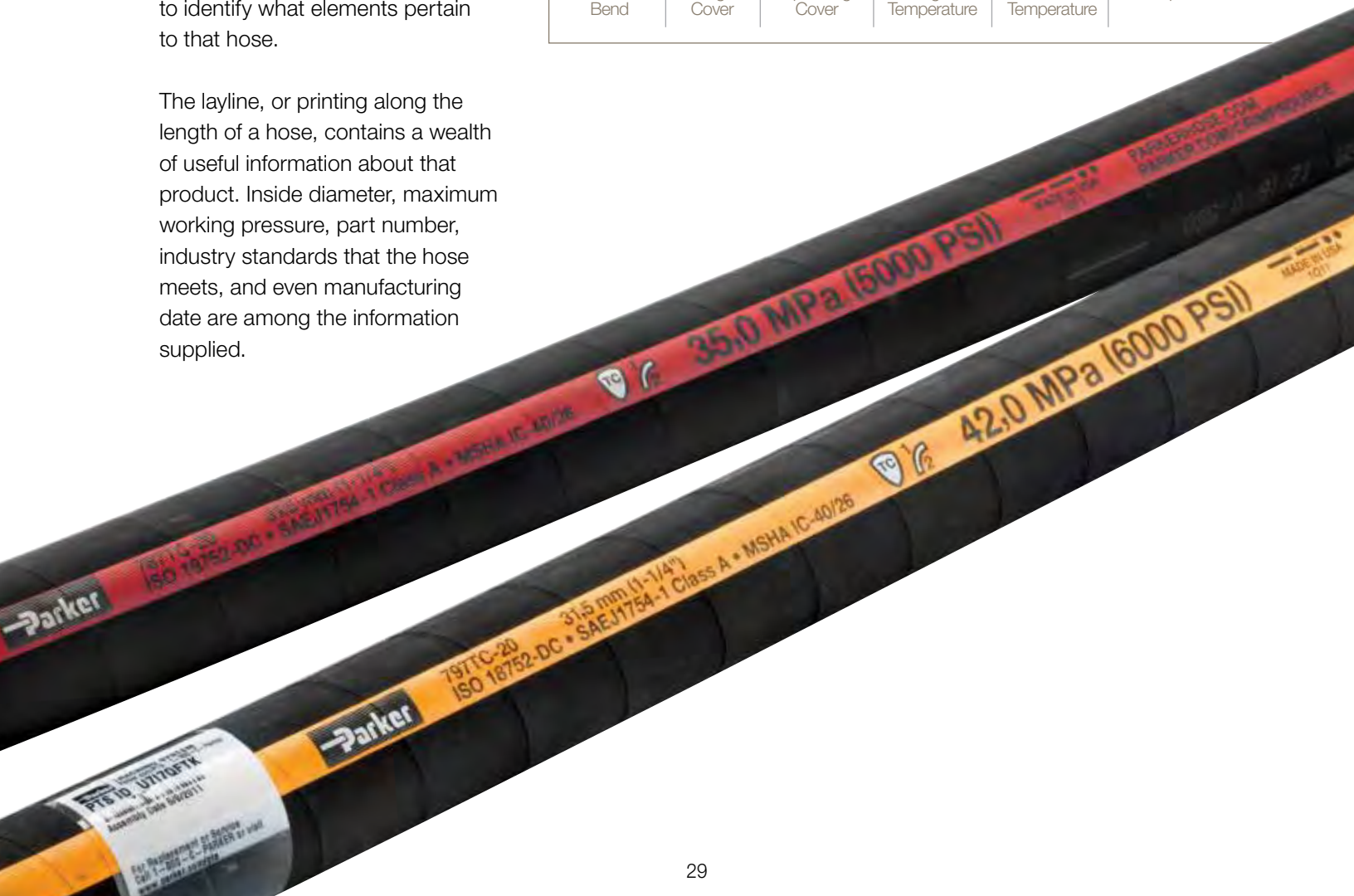

Parker Fittings. The products of choice for custom and standard applications.



Crimpable fittings

Parker Parkrimp assemblies consist of No-Skive hose and fittings, permanently joined by any one of our Parkrimp crimpers. The teeth in Parker's crimped fittings bite down to the hose wire for a metal-to-metal grip with maximum integrity. Our one-piece fittings can be combined with many No-Skive hose types to cover low-, medium- and high-pressure applications, as well as special application categories that can also be used with permanent crimped fittings.

We offer steel, brass, and stainless steel fittings from 3/16" to 3", with our steel fittings featuring a corrosion-resistant plating that exceeds SAE standards. Styles include o-ring face seal, flare, male pipe, metric designs and many more. All are compatible with the easy-to-use Parkrimp system of crimping machines.

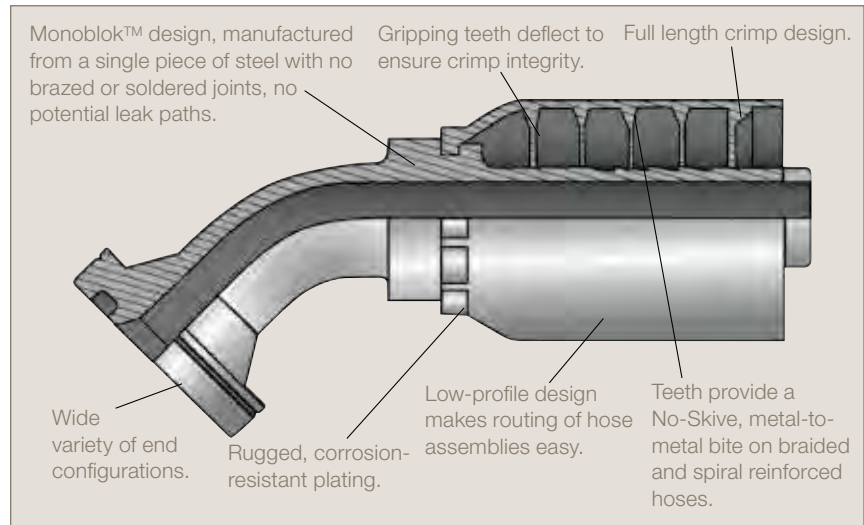

When combined with our No-Skive hose, Parker Parkrimp fittings provide factory-quality hose assemblies quickly and cost effectively.

Monoblok™ fittings

Monoblok™ fittings are manufactured from a single piece of steel. First introduced in ultra-high-pressure hydraulic applications, their lack of brazed or

soldered joints provides the utmost in leak protection, eliminating any potential leak paths. Parker Monoblok fittings are available in a wide variety of end configurations and fitting series. These fittings also feature: No-Skive, bite-the-wire, full-length crimp, corrosion-resistant plating, weather seal, and a low-profile design.



Metric fittings

Parker's metric fittings are available in a full range of DIN, BSP, BSPP, French GAZ, and JIS configurations to meet worldwide applications. Parker's metric fittings are available in a wide range of sizes to meet your requirements.

Field attachable fittings

Parker field attachable fittings enable you to make hose assemblies right at the job site without special tools or machines.

Our wide range of No-Skive hose – hose that does not require the removal of the outer cover or inner tube prior to assembly – combines with a variety of field attachable steel, stainless steel, and brass fittings quickly and easily.

Parker field attachable fittings include the popular Push-Lok® style, as well as two- and three-piece series fittings that use an interchangeable nipple with one- and two-wire braided hose.

Custom fittings for short-run or special applications

Custom tube and hose fittings are available from Parker. Configurations include NPTF, JIC, SAE, GAZ, ISO, DIN, JIS,

and BSP in a wide range of sizes. Material options include steel, stainless steel, brass, aluminum, and Monel®. All of our products are manufactured to world-class standards.

Hose Hint

How tight is tight enough? Differences in platings and other variables can affect the amount of torque required to ensure a proper connection. Always refer to this catalog or go to www.parkerhose.com for proper assembly procedures.

Hose End Type	Pressure	Seal Reliability	Vibration Resistance	Ease of Installation	Reusability	Temperature
Seal-Lok – O-Ring Face Seal	Excellent	Excellent	Very Good	Excellent	Excellent	Limited by Seal
37° Flare	Very Good	Good	Good	Good	Good	Excellent
Tapered – (NPT, NPTF, BSPT and Metric Taper)	Good*	Poor	Poor	Good	Poor	Excellent
Four-Bolt Flange	Excellent	Good	Excellent	Very Good	Excellent	Limited by Seal

**Rated 'Poor' for dynamic pressure systems.*

Hose Hint

Never mix and match one manufacturer's fittings with hose from another manufacturer. Parker hose, fittings, and crimpers are designed to work together as a system. This ensures optimum product performance, reliability, and safety.



Fittings with XTR coating for extreme resistance to corrosion

Parker XTR coating provides more than seven times SAE standard protection. An outstanding advantage for equipment in highly caustic applications and environments, Parker's proprietary formulation has been tested to resist corroding for more than

720 hours. Parker products with XTR coating assure all the leak-free performance and installation advantages that our customers expect. Even the assembly torque remains the same. For unmatched quality, service and support, now with extreme corrosion resistance, specify Parker hose and tube fitting products with XTR coating. For additional information, refer to Bulletin 4480-B158.

Parkrimp Crimpers.

Easy to use for safe and reliable high performance hose assemblies



With Parkrimp, you benefit from a full-length crimp. Our low-profile design makes routing hose assemblies easy. No-Skive hoses and fittings combine with the Parkrimp system to create high-quality, reliable hydraulic hose assemblies every time.

The complete system from one source: No-Skive hose, No-Skive fittings, and crimping machines with worldwide availability and service.

Parker's Parkrimp system provides users with several key advantages:

- **Perfect alignment:** Parker's exclusive Parkalign™ system features a positive-stop design that positions the fitting in the die for a perfect crimp every time. Parkalign benefits operators by enabling them to "feel" that the hose is in the right position to be crimped, as compared to "eyeballing" the proper position of the fitting in a variable crimper.
- **Efficient design:** Bottomloading Parkrimp crimpers make it much easier for operators to manage long hose assemblies.
- **Linked dies:** Parkrimp dies are linked together to prevent segments from being misplaced or worse, mismatched.
- **Color-coded dies:** Parkrimp dies are color coded by size, making for easy identification and reduced set-up time.
- **Durability:** Since they were introduced in 1980, Parkrimp crimpers have been designed and manufactured to provide years of reliable service.
- **Decals:** Parkrimp crimpers come with an information-rich decal that provides the list of proper hose and fitting combinations, tools required and the crimp specification for each hose and fitting combination.
- **Crimpsource:** the most complete online resource for Parker crimp specifications, technical manuals, decals and more.

Parker Hose Product Division also offers a full line of crimping accessories, including conversion kits, cabinets, cut-off saws, push-on tables, die racks, and mandrel tool kits. See the Equipment section for full details.

Modular design with all the familiar Parkrimp system advantages

Parker offers two Parkrimp-style modular crimpers – the Karrykrimp and the Karrykrimp 2. Their modular design enables the customer to choose between the portability that Parker Karrykrimp crimpers have always offered and the new option to make these same crimpers bench-mounted units.

The modular design gives users the flexibility of a portable crimper with the advantage of increased productivity when connected to the stationary power unit.

Modular Crimper – Portable or Bench-Mounted

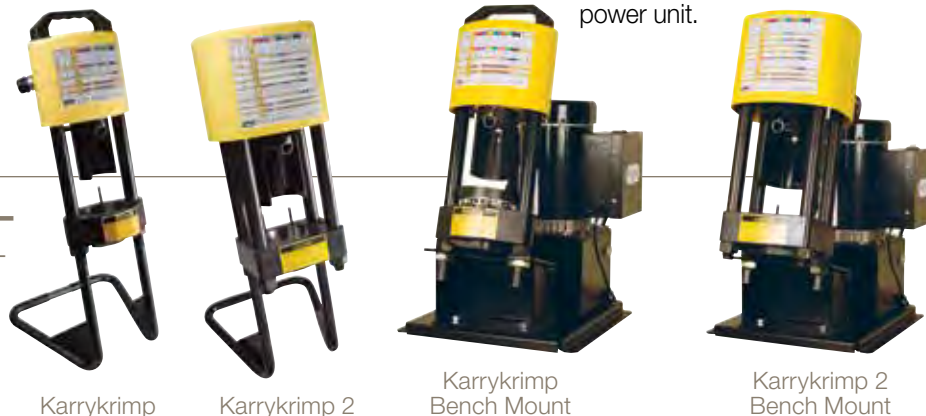

Karrykrimp

Karrykrimp 2

Karrykrimp Bench Mount

Karrykrimp 2 Bench Mount

Eight-segment crimp dies provide a smooth, even, 360-degree crimp.

Our linked crimp dies keep die segments together. No loose parts to mismatch or misplace.

Dies are color coded by size for easy identification and reduced set-up time.

Bottom-loading operation makes it easy to handle long hose assemblies.

Parker's exclusive Parkalign™ feature positions the fitting in the dies perfectly every time.

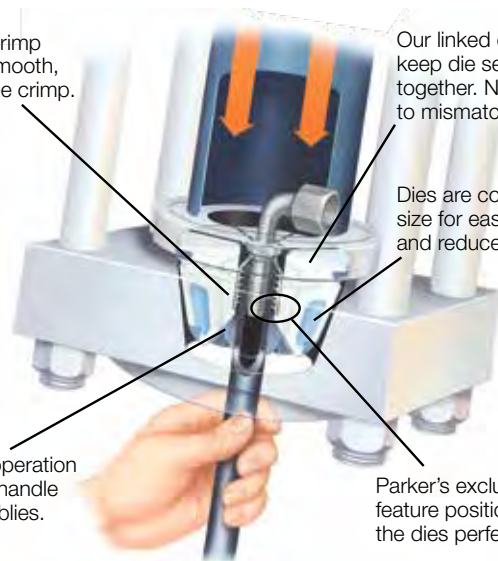

Parkrimp dies are color coded and linked together – making them easy to use.

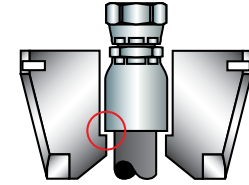

The Parkalign system's positive stop feature ensures users will make a perfect crimp every time.

Downloadable decals are just one of the many assets found on Crimpsource.

The modular crimper features:

- A single crimping unit can be either portable or bench-mounted
- Faster cycle times on bench mounted units
- Increased height enables longer bent tube fittings to be crimped
- Cylinder maintenance on the Karrykrimp 2 is now possible

Parker's Parkrimp® System continues to lead the industry in ease of use, accuracy and effectiveness. The Parkrimp system is designed to crimp fittings to the proper diameter every time, meaning fluid power professionals will not waste valuable time dialing variable settings that can produce mis-crimps. Designed to produce accurate crimps from the first time it's used, Parkrimp system crimpers require no calibration and continuously produce proper crimps, time after time.

P/N: PK2 HOSE DECAL 4/11 Rev. 0	Fittings	Die Selection and Crimp Diameters										P/N: PK2 MASTER DECAL 4/11				
		8 RED	9 PUR	10 YEL	11 BLU	12 GRN	13 GRN	14 BLK	15 WHT	16 RED	17 GRN	18 BLK	19 WHT	20 RED	21 GRN	
321TC	331	371ST	0.645	0.710	0.825	0.945	1.060	1.245	1.590	1.970	2.290	2.735				
351ST	436	472TC	0.685	0.730	0.845	0.965	1.080	1.265	1.610	1.990	2.310	2.755				
422	481TC	482TC														
434	451ST	482ST														
436	471TC															
Tools Required			Steel Silver Die (RSC-XXX) and Adapter Bowl (RSC-OCB)										Large Silver Die (RSC-XXX)			
421WC	304	301	0.685	0.750	0.865	0.985	1.100	1.285	1.630	2.010	2.330	2.775				
3502M	341	404	0.705	0.770	0.885	1.005	1.120	1.305	1.650	2.030	2.350	2.795				
301LT	381	881														
722TC-4.8mm-20.0mm																
Tools Required			Special Ring (RSC-PGR), Small Silver Die (RSC-XXX), and Adapter Bowl (RSC-OCB)										Special Pads (SC-PGH) and Large Silver Die (RSC-XXX)			
Die			48C-DW	1.140	1.260	1.380	1.500	1.620	1.740	1.860	1.980	2.100	2.220	2.340	2.460	

Parker Crimpsource™

Crimpsource is the industry's most complete resource for crimper technical information. It contains all of the crimp specifications approved for Parker's rubber, industrial and thermoplastic hose:

- Crimp specs
- PDFs of technical manuals for easy downloading
- Parts lists
- Troubleshooting advice
- PDFs of crimper decals for immediate printing

Crimpsource provides easy access to all the specifications necessary to correctly fabricate a factory quality hose assembly.

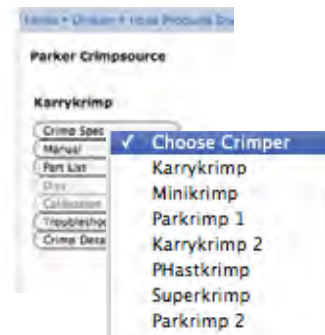

A series of drop-down menus enables users to find what they need quickly and easily. Choose your crimper and then select the hose, fittings and current specifications needed to make hose assemblies.

You can also print a simple-to-follow data specification sheet or crimper decal. Crimpsource is available at www.parker.com/crimpsource.

Parker's superior capabilities.

Your competitive advantages.

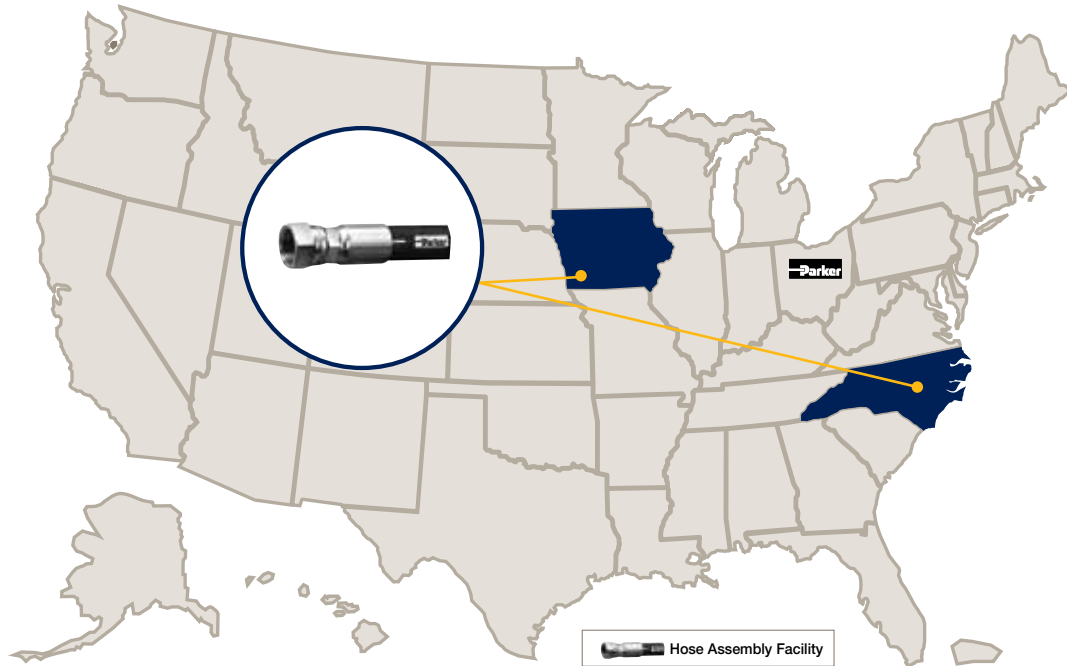

Downloadable CAD drawings

Downloadable CAD drawings of Parker fittings are available at www.parkerhose.com. You can check the form, fit, and function of the fitting before specifying the actual part.



Online 3D-CAD models help designers work faster, smarter.

Custom manufacturing capabilities

Markets are shifting to replacing sections of hose with hard plumbing. These custom projects can include tube fabrication and fittings not found anywhere else. Using custom tube and compound assemblies can reduce your overall costs and eliminate warranty issues.

Completely custom products are available from a dedicated Parker Hose Products Division facility. Using standard Parker hoses, fittings and tubing, our experts create custom tube and compound assemblies that exactly match your specifications to provide increased durability and reliability.

Organized to provide fast quotes and highly responsive service,

our Custom Manufacturing department can produce a single critical piece or production quantities to meet your needs, quickly and efficiently. Contact our staff to talk about creating the best in customized, leak-free products. Call **888-882-1202**.

Dedicated hose assembly plants

All Parker Hose assemblies are manufactured in our own facilities solely dedicated to hose assembly production and premier customer service. Our dedicated hose assembly plants offer our customers unique benefits including:

- **Competitive hose assembly pricing**
- **A more diverse range of hose assembly capabilities and accessory options**

- **A larger selection of hose and fitting inventory for assemblies**
- **The quality assurance that comes with manufacturing in a TS-16949-certified facility**

Custom kits

Want to speed up assembly on the factory floor? Parker custom kits are just what you're looking for. From fittings and adapters to pre-made assemblies, custom kits can hold a wide range of materials, in the exact order and quantities you need.



What's the advantage? Streamlined procedures. Quicker assembly. Lower costs. And a single part number for easier processing. Call your Parker representative today.

Parker experts can create custom tube and compound assemblies that exactly match your specifications.



Technical support, education and training

Need help? Don't hesitate to ask. Our technicians and market-specific engineers can be found around the country and throughout the world to offer you engineering support, fluid connector system design, and product selection assistance. Phone consultation, as well as on- or off-site sessions are available virtually anywhere for all customers, distributors, and employees. Topics range from hose routing tips and troubleshooting to critical safety procedures. Our Parker experts reflect our extensive commitment to training and education, and are an important part of our value-added services.

Want some help? Call **1-800-C-PARKER**, or check with your local distributor. Don't know who that is? Go to **www.parker.com** then click on "where to buy" on the home page to find out.



Parker Training and Certification (P-TAC)

P-TAC encompasses online (e-learning) and off-line (instructor-led classroom) training in addition to certification recognition.

Parker.com/PTAC

NOTES

NOTES

NOTES



Constant Working Pressure
Hydraulic – Industry Standard
Suction and Return
Push-Lok®
Phosphate Ester
Low Temperature
Transportation
Alternative/Marine Fuel
Refrigerant

Hose





















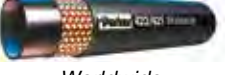

A



ENGINEERING YOUR SUCCESS.

















Hose visual index

A

<p>Constant Working Pressure Hose</p>	<p>451TC A-10  Tough Cover – SAE 100R17</p>	<p>451ST A-10  Super Tough - SAE 100R17</p>	<p>451TC A-11  Hydraulic Twin Tough</p>
<p>711 A-12  SAE J1942</p>	<p>351TC A-13  Tough Cover 4,000 psi Constant W.P.</p>	<p>351ST A-13  Super Tough 4,000 psi Constant W.P.</p>	<p>722TC A-14  Tough Cover 4,000 psi Constant W.P.</p>
<p>772TC A-15  Tough Cover - SAE 100R12</p>	<p>772ST A-15  Super Tough - SAE 100R12</p>	<p>721 A-16  SAE 100R12</p>	<p>721TC A-16  Extreme Tough Cover SAE 100R12</p>
<p>721ST A-17  Super Tough - SAE 100R12</p>	<p>787TC A-18  Compact Spiral™ Hose</p>	<p>781 A-20  SAE 100R13</p>	<p>P35 A-20  SAE 100R13</p>
<p>782TC A-21  Tough Cover SAE 100R13</p>	<p>782ST A-21  Super Tough SAE 100R13</p>	<p>797TC A-22  Compact Spiral™ Hose</p>	<p>791TC A-24  Extreme Tough Cover SAE 100R15</p>
<p>792TC A-24  Tough Cover - SAE 100R15</p>	<p>761 A-25  ParMax - 8,000 psi</p>		
<p>Hydraulic – Industry Standard Hose</p>	<p>JK A-25  Jack Hose</p>	<p>422 A-26  Worldwide ISO 1436-1 TYPE 1SN</p>	<p>482TC A-27  Tough Cover SAE 100R1 TYPE AT</p>
<p>482ST A-27  Super Tough SAE 100R1 TYPE AT</p>	<p>426 A-28  High-Temperature SAE 100R1 TYPE AT</p>	<p>302 A-29  Worldwide ISO 1436-1 TYPE 2 SN</p>	<p>431 A-30  Compact - SAE 100R16</p>
<p>436 A-31  SAE J1942</p>	<p>471TC A-32  Tough Cover ISO 11237-1 TYPE 2 SC</p>	<p>471ST A-32  Super Tough ISO 11237-1 TYPE 2 SC</p>	<p>471TC A-33  Hydraulic Twin Tough</p>
<p>472TC A-33  Tough Cover Two-Wire Braid</p>	<p>AX A-34  One-Wire Braid</p>	<p>BXX A-34  SAE 100R2 TYPE AT</p>	<p>701 A-35  ISO 3862-1 TYPE 4SP</p>
<p>731 A-35  ISO 3862-1 TYPE 4SH</p>			

Hose visual index

A

<p>Suction & Return Line Hose</p>	<p>811 A-36  1/2 SAE Minimum Bend Radius SAE 100R4</p>	<p>811HT A-37  SAE 100R4</p>	<p>881 A-37  1/2 SAE Minimum Bend Radius SAE 100R4</p>
<p>Push-Lok Multipurpose Hose</p>	<p>801 A-38  Push-Lok® Plus</p>	<p>836 A-40  Multipurpose High-Temperature</p>	<p>804 A-40  Dry Air/Hot Water</p>
<p>821FR A-41  Multipurpose Fire Resistant Cover</p>	<p>821 A-41  Multipurpose</p>		
<p>Phosphate Ester Hose</p>	<p>424 A-42  Phosphate Ester Base Fluids</p>	<p>304 A-43  Phosphate Ester Base Fluids</p>	<p>774 A-43  Phosphate Ester Base Fluids</p>
<p>F42 A-43  Phosphate Ester Base Fluids</p>			
<p>Low-Temperature Hose</p>	<p>301LT A-44  -67/+212</p>	<p>472LT A-45  -70/+212</p>	<p>722LT A-45  -70/+212</p>
<p>792LT A-45  -70/+212</p>			
<p>Transportation Hose</p>	<p>293 A-46  Air Brake Hose SAE J1402</p>	<p>213 A-47  SAE J1402 AI</p>	<p>266 A-47  SAE J1402 All</p>
<p>201 A-48  SAE 100R5 SAE J1402 All</p>	<p>206 A-48  SAE 100R5 SAE J1402 All</p>	<p>611HT A-49  EN 854</p>	<p>271 A-50  Air Brake Hose SAE J1402 A</p>
<p>Alternative/Marine Hose</p>	<p>SS23CG A-51  Compressed Natural Gas and Liquefied Petroleum Gas</p>	<p>SS25UL A-52  Liquefied Petroleum Gas</p>	<p>221FR A-53  Marine Fuel and Engine Hose</p>
<p>Refrigerant Hose</p>	<p>285 A-54  SAE J2064 TYPE C</p>	<p>244 A-55  SAE J2064 TYPE B</p>	

How to read the hose section

Parker offers a wide variety of hoses including braided, spiral, multi-purpose, transportation, refrigerant, LP gas and more. Parker's product line has been tested and approved to meet

and exceed global standards. Our hoses range in size from 3/16" to 3" I.D. and are compatible with crimp and field-attachable style fittings. Specific hose information is displayed throughout Catalog 4400

Hose Section. Hose page content is defined by the information shown below. Please take a moment and review.



Markets



Catalog Sections

- Hose Section
- Accessories Section
- Fittings Section
- Technical Section
- Equipment Section

Parker Hose Nomenclature

Example: 451TC-8
451TC-8 - Hose Type
 451**TC**-8 - Indicates the special feature of the hose (in this case, 'Tough Cover')
 451TC-**8** - Hose inside diameter dash size (in this case, 8/16" or 1/2")

Hose Information

- Base part number
- Description
- SAE, ISO, and EN specifications

Hose Inner Diameter

Measured in 1/16 inch increments identified by use of a "dash"(-) numbering system. i.e., 4/16" = 1/4" = -4.

Hose Outer Diameter

A critical measurement when considering hose clamps and applications where envelope size is limited.

Hose Working Pressure

Should have a working pressure rating meeting or exceeding the maximum operating pressure of the system. The maximum rating is listed below for where the hose is to be used.

Visually shows **hose construction**.

482TC
 Hydraulic – Tough Cover
 SAE 100R1 TYPE AT, J1942 / ISO 1436-1 TYPE 1SN / EN853 TYPE 1SN / USCG H

482ST
 Hydraulic – Super Tough Cover
 SAE 100R1 TYPE AT / ISO 1436-1 TYPE 1SN / EN853 TYPE 1SN

# Part Number	Hose I.D.		Hose O.D.		Working Pressure		Minimum Bend Radius		Weight		Field Attachable	
	inch	mm	inch	mm	psi	MPa	inch	mm	lbs/ft	kg/m	43 Series	42 Series
482TC/ST-4	1/4	6,3	0,53	14	3250	22,7	2	50	0,16	0,24	•	•
482TC-5	5/16	8	0,59	15	3250	22,7	2-1/4	55	0,18	0,27	•	•
482TC/ST-6	3/8	10	0,69	17	3000	21,0	2-1/2	65	0,23	0,34	•	•
482TC/ST-8	1/2	12,5	0,82	21	2500	17,5	3-1/2	90	0,29	0,43	•	•
482TC/ST-10	5/8	16	0,94	24	2000	14,0	4	100	0,33	0,49	•	•
482TC/ST-12	3/4	19	1,09	28	1750	12,2	4-3/4	120	0,42	0,63	•	•
482TC/ST-16	1	25	1,41	36	1275	8,8	6	150	0,63	0,94	•	•

Application: Petroleum base hydraulic fluids and lubricating oils.
Inner Tube: Synthetic rubber.
Reinforcement: One braid steel wire.
Cover: Synthetic rubber abrasion resistant, MSHA accepted.
Temperature Range: -40°F to +212°F (-40°C to +100°C).
Fittings: 43 Series - pg. B-00, 42 Series - pg. B-00.

• Field Attachable Assembly Instructions are in Section B with Field Fittings Series.
 • See Section C for Fittings Assembly Instructions.
 • Temperature Range of other media listed in Section E.

A-27

For more information regarding hose application and temperature, see the Technical Section.

Minimum Bend Radius

Is the smallest arc that the hose can be bent before its life is greatly reduced. Exceeding the bend radius can cause kinking, inner tube washout and excessive stress on reinforcement.

Weight

Provided by the foot for instances where it is a critical parameter in the design of the system.

Approved Fitting

































To be used with the hose. Could be crimped or field attachable.

Hose overview chart

A

	Hose Size	Hose Reinforcement	Working Pressure (psi)												Standard Temp. Range °F	SAE	ISO	EN	Page		
			-4	-5	-6	-8	-10	-12	-16	-20	-24	-32	-40	-48							
Constant Working Pressure	451TC/ST		3000		3000	3000	3000	3000	3000	3000							-40/+212	100R17			A-10
	451TC Twin Tough				3000	3000											-40/+212	100R17	11237-1		A-11
	711										3000	3000					-40/+212				A-12
	351TC/ST		4000		4000	4000	4000	4000									-40/+212	100R19			A-13
	722TC				4000	4000	4000	4000	4000	3000	2500	2500					-40/+257	100R12 J1942	3862-1 Type R12	Type R12	A-14
	772TC/ST				4000	4000	4000	4000	4000	3000	2500	2500					-40/+257	100R12	3862-1-R12	856-R12	A-15
	721/721TC				4000	4000	4000	4000	4000	3000	2500	2500					-40/+257	100R12	3862-1-R12	856-R12	A-16
	721ST				4000	4000	4000	4000	3000								-40/+257	100R12	3862-1-R12	856-R12	A-17
	787TC				5000	5000	5000	5000	5000								-40/+257	100R13	18752-DC		A-18
	781						5000	5000	5000	5000											A-20
	P35										5000						-40/+257	100R13	3862-1-R13	856-R13	A-20
	782TC/ST								5000	5000	5000	5000					-40/+257	100R13	3862-1-R13	856-R13	A-21
	797TC					6000	6000	6000	6000	6000							-40/+257	100R15	18752-DC		A-22
	791TC						6000	6000	6000	6000							-40/+257	100R15	3862-1-R15		A-24
	792TC/ST						6000	6000									-40/+257	100R15	3862-1-R15		A-24
761						8000	8000									-40/+257				A-25	
Hydraulic - Industry Standard	JK		10500		10000												-40/+120				A-25
	422		3250	3125	2600	2325	1875	1525	1275	900	725	575					-40/+212	100R1AT	1436-1-1SN		A-26
	482TC/ST		3250	3250	3000	2500	2000	1750	1275								-40/+212	100R1AT	1436-1-1SN	853-1SN	A-27
	426		2750		2250	2000	1500	1250	1000	625	500	375					-50/+302	100R1AT			A-28
	302		5800	5000	4750	4000	3600	3100	2400	1800	1300	1150					-40/+212	100R2	1436-1-2SN		A-29
	431		5000	4250	4000	3500	2750	2250	2000								-40/+257				A-30
	436				4000	3500	2750	2250	2000								-55/+302				A-31
	471TC/ST		5800		5000	4250	3625	3125	2500								-40/+212		11237-1-2SC	857-2SC	A-32
	471TC Twin Tough				5000	4250											-40/+212		11237-1-2SC	857	A-33
	472TC									2250	1800	1300					-40/+212				A-33
AX		3000		3000	2500	1500	1250	1000								-40/+212				A-34	

Hose overview chart

	Hose Size	Hose Reinforcement	-4	-5	-6	-8	-10	-12	-16	-20	-24	-32	-40	-48	Standard Temp. Range °F	SAE	ISO	EN	Page
Hydraulic	BXX		5000		4000	3500	2750	2250	2000						-40/+212	100R2			A-34
	701				6500	6000	5000								-40/+212		3862-1-4SP	856-4SP	A-35
	731							6000	5500	4700	4200	3600			-40/+212		3862-1-4SH	856-4SH	A-35
Suction and Return Line	811/811HT with HC							100	70	50	50	50	62		-40/+212	100R4			A-36
	811/811HT with 81							300	250	200	150	100	62		-40/+212	100R4			A-37
	881 with HC							100	70	50	50	50	62		-40/+257	100R4			A-37
	881 with 43/81/DB							300	250	200	150	100	62		-40/+257	100R4			A-37
Push-Lok	801		350		350	300	300	300	200						-40/+212				A-38
	836		400		400	400	350	300							-55/+302				A-40
	804		150		150	150	150	150							-40/+176				A-40
	821FR		350		300	300		250							-40/+212				A-41
	821		350		300	300	250	250							-40/+212				A-41
Phosphate Ester	304		5000		4000	3500	2750	2250	2000	1625	1250	1125			-40/+176				A-43
	774							4000	4000	3000	2500	2500			-40/+176				A-43
	424								1000	625	500	375			-40/+176	100R1AT			A-42
	F42					6000		6000	6000	6000					-40/+176				A-43
Low-Temp	301LT		5000		4000	3500	2750	2250	2000						-67/+212	100R2			A-44
	472LT		5800		5000	4250	3625	3125	2500						-70/+212			857	A-45
	722LT				4000	4000	4000	4000	4000	3000	2500				-70/+212	100R12	3862-1-R12	856	A-45
	792LT								6000	6000	6000				-70/+212				A-45
Transportation	293		500		500	500	450	450	450						-58/+302	J1402 AI			A-46
	213		2000	1500	1500	1250	1000	750	400	300	300	200	175		-50/+302	J1402 AI			A-47
	266		2000	1500	1500	1250	1250	750	400	300	250				-55/+302	J1402 AII			A-47
	201		3000	3000	2250	2000	1750	1500	800	625	500	350	350	200	-40/+302	100R5/ J1402 AII			A-48
	206		3000	3000	2250	2000	1750	1500	800	625	500	350	350		-55/+302	100R5/ J1402 AII			A-48
	611HT		400		400	400	350	300							-55/+302	J517 Type R6		854	A-49
	271				225	225									-50/+212	J1402 A			A-50
Alternative/Marine	SS23CG				425	425	425	425							-40/+250				A-51
	SS25UL		350	350	350	350	350	350							-40/+250				A-52
	221FR			500	500	500	500	500	500						-4/+212	J1527 R3/J1942	7840		A-53
Refrigerant	285		500		500	500	500	500							-22/+257	J2064 Type C			A-54
	244								500	500	350				-22/+257	J2064 Type B Class 1			A-55

How to order crimped hose assemblies

A

Box 1	Box 2	Box 3	Box 4	Box 5	Box 6	Box 7	Box 8	Box 9	Box 10	Box 11
F	436	06	39	08	08	08		-24		

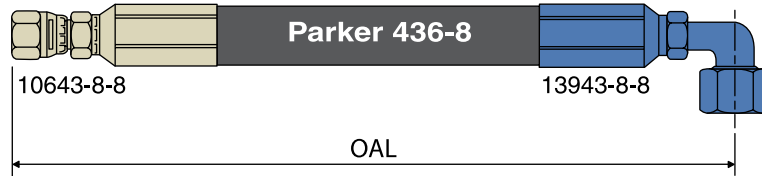

Box 1: Prefix	
Symbol	Description
F =	Parkrimp Crimp Fittings (43, 71, 77 Series, etc.)
P =	Parkrimp Crimp Fittings (26 Series only)
Y =	Permanent Crimp Fittings (HY Series only)
K =	Permanent Crimp Fittings (81 Series only)

Box 2: Hose Type	
Symbol	Description
436 =	SAE 100R16 Hose
Note: see page A-6 for complete list of Parker Hoses	

Box 3: 1st Fitting End Configuration	
Symbol	Description
06 =	Female JIC 37 Degree Swivel Straight
Note: See page E-30 for a complete list of fitting configurations	

Box 4: 2nd Fitting End Configuration	
Symbol	Description
39 =	Female JIC 37 Degree Swivel 90 Degree Elbow - Short Drop

Box 5: 1st Fitting End Connection Size	
Symbol	Description
08 =	1/2" Female JIC (3/4x16 Thread)

Box 6: 2nd Fitting End Connection Size	
Symbol	Description
08 =	1/2" Female JIC (3/4x16 Thread)

Box 7: Hose Size	
Symbol	Description
08 =	1/2 inch Hose Inner Diameter

Box 8: Fitting Material	
Symbol	Description
No Suffix =	Steel
B =	Brass
C =	316 Stainless Steel
BA =	Brass nipple with steel nut and socket
BS =	Brass nipple with brass nut and steel socket

Box 9: Over All Length (OAL)	
Symbol	Description
24 =	Expressed in inches (610 mm)
OAL of a hose assembly is measured from the end of the straight fitting or centerline of the fitting seat. OAL of the Seal-Lok® hose assembly is measured to the sealing surface of the straight fittings or to the centerline of the elbow fittings	

Box 10: Displacement Angle	
Symbol	Description
270	Specified only if two (2) elbow fittings are used. Starting with either end as the far end, measure angle clockwise to describe the displacement angle of the near end

Box 11: Hose Assembly Guards	
Symbol	Description
SG =	Spring Guard
AG =	Armor Guard
HG =	Polyguard
PG =	ParKoil™
FS =	Fire Sleeve
AS =	Partek Sleeving
PS =	Partek Sleeving
Note: When spelling out an assembly part number, list entire sleeving part number	

How to order field attachable hose assemblies

Box 1	Box 2	Box 3	Box 4	Box 5	Box 6	Box 7	Box 8	Box 9	Box 10	Box 11
R	201	06	39	06	06	08		-24		

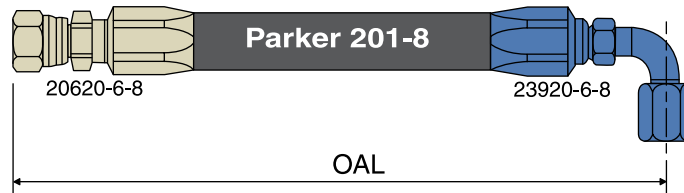

Box 1: Prefix	
Symbol	Description
R =	Field Attachable (all series except 22 & 23)
M =	Field Attachable (22 & 23 Series only)
B =	Clamp i.e., 88HC-H and 88DB on 88 Series
C =	Worm Gear Clamp i.e., 88H Series on 88 Series

Box 2: Hose Type	
Symbol	Description
201 =	SAE 100R5

Note: See page A-6 for complete list of Parker Hoses

Box 3: 1st Fitting End Configuration	
Symbol	Description
06 =	Female JIC 37 Degree Swivel - Str.

Note: See page E-30 for a complete list of fitting configurations

Box 4: 2nd Fitting End Configuration	
Symbol	Description
39 =	JIC 37 Degree Flare Elbow

Box 5: 1st Fitting End Connection Size	
Symbol	Description
06 =	3/8" JIC (9/16x18 Thread)

Box 6: 2nd Fitting End Connection Size	
Symbol	Description
06 =	3/8" JIC (9/16x18 Thread)

Box 7: Hose Size	
Symbol	Description
08 =	13/32 inch Hose Inner Diameter

Box 8: Fitting Material	
Symbol	Description
No Suffix =	Steel
B =	Brass
C =	316 Stainless Steel
BA =	Brass nipple with steel nut and socket
BS =	Brass nipple with brass nut and steel socket

Box 9: Over All Length (OAL)	
Symbol	Description
24 =	Expressed in inches (610 mm)

OAL of a hose assembly is measured from the end of the straight fitting or centerline of the fitting seat. OAL of the Seal-Lok® hose assembly is measured to the sealing surface of the straight fittings or to the centerline of the elbow fittings

Box 10: Displacement Angle	
Symbol	Description
270	Specified only if two (2) elbow fittings are used. Starting with either end as the far end, measure angle clockwise to describe the displacement angle of the near end

Box 11: Hose Assembly Guards	
Symbol	Description
SG =	Spring Guard
AG =	Armor Guard
HG =	Polyguard
PG =	ParKoil™
FS =	Fire Sleeve
AS =	Partek Sleaving
PS =	Partek Sleaving

Note: When spelling out an assembly part number, list entire sleaving part number

• See page E-14 for Agency Approval For Building Hose Assemblies Key



HYDRAULIC

451TC/ST, 451TC Twin Tough



Parker 451TC and 451ST hydraulic hoses are what to specify when abrasion resistance and ease of use are required. Plus, you can choose the cover that provides the abrasion resistance for your application.

- One-half SAE 100R1 minimum bend radius – flexible, easy to work with and install
- Specially engineered TC and ST covers prolong hose life and minimize downtime
- 3,000 psi constant working pressure in all sizes
- Exceeds SAE 100R17 specification



**451TC
Hydraulic – Tough Cover**

SAE 100R17, J1942 / ISO 11237 – 1 TYPE R17 – Constant Working Pressure / USCG HF / ABS



**451ST
Hydraulic – Super Tough Cover**

SAE 100R17 / ISO 11237 - 1 TYPE R17 – Constant Working Pressure



Application: Petroleum base hydraulic fluids and lubricating oils.
Inner Tube: Synthetic rubber.
Reinforcement: One or two braid steel wire (4-spiral for size -20).
Cover: Synthetic rubber abrasion resistant, MSHA accepted.
Temperature Range: -40°F to +212°F (-40°C to +100°C).
Fittings: 43 Series - pg. B-27.

# Part Number	Hose I.D.		Hose O.D.		Working Pressure		Minimum Bend Radius		Weight		Parkrimp 43 Series
	inch	mm	inch	mm	psi	MPa	inch	mm	lbs/ft	kg/m	
451TC/ST-4	1/4	6,3	0.52	13	3000	21,0	2	50	0.16	0,24	●
451TC/ST-6	3/8	10	0.68	17	3000	21,0	2-1/2	65	0.23	0,34	●
451TC/ST-8	1/2	12,5	0.80	20	3000	21,0	3-1/2	90	0.35	0,52	●
451TC/ST-10	5/8	16	0.94	24	3000	21,0	4	100	0.44	0,66	●
451TC/ST-12	3/4	19	1.10	28	3000	21,0	4-3/4	120	0.58	0,86	●
451TC/ST-16	1	25	1.40	35	3000	21,0	6	150	0.79	1,17	●
451TC/ST-20	1-1/4	31,5	1.85	47	3000	21,0	8-1/4	210	1.50	2,23	●

- See Section C for Parkrimp Assembly Instructions.
- Temperature Range of other media listed in Section E.



Twin Tough hoses eliminate the labor and material costs required to manually bundle two separate hoses using tie straps or plastic sleeves. Plus, Parker’s Twin Tough saves valuable time in the field.

- 3,000 psi constant working pressure in -6-6 and -8-8
- One-wire braided construction
- Abrasion-resistant TC cover



Application: Petroleum base hydraulic fluids and lubricating oils.
Inner Tube: Synthetic rubber.
Reinforcement: One braid steel wire.
Cover: Synthetic rubber abrasion resistant, MSHA accepted.
Temperature Range: -40°F to +212°F (-40°C to +100°C).
Fittings: 43 Series - pg. B-27.

451TC Hydraulic – Twin Tough Cover

SAE 100R17, J1942 / ISO 11237 – 1 TYPE R17 – Constant Working Pressure / USCG HF / ABS

# Part Number	Hose I.D.		Hose O.D.		Working Pressure		Minimum Bend Radius		Weight		Parkrimp 43 Series
	inch	mm	inch	mm	psi	MPa	inch	mm	lbs/ft	kg/m	
451TC-6-6	3/8	10	0.68	17	3000	21,0	2-1/2	65	0.46	0,68	●
451TC-8-8	1/2	12,5	0.80	20	3000	21,0	3-1/2	90	0.70	1,04	●

For assembly instructions see page C-18.

- See Section C for Parkrimp Assembly Instructions.
- Temperature Range of other media listed in Section E.

HYDRAULIC

711



711 hose is a medium-pressure, 4-wire spiral constructed hose offered in two large I.D. sizes. Designed for high-impulse, long-life applications like injection molding.

- 3000 psi constant working pressure

Application: Petroleum base hydraulic fluids and lubricating oils.

Inner Tube: Synthetic rubber.

Reinforcement: Four spiral steel wire.

Cover: Synthetic rubber, MSHA accepted.

Temperature Range: -40°F to +212°F (-40°C to +100°C).

Fittings: 71 Series - pg. B-71.

711 Hydraulic

J1942 / USCG HF / DNV / ABS



# Part Number	Hose I.D.		Hose O.D.		Working Pressure		Minimum Bend Radius		Weight		Parkrimp 71 Series
	inch	mm	inch	mm	psi	MPa	inch	mm	lbs/ft	kg/m	
711-24	1-1/2	38,0	2.07	53	3000	21,0	22	560	2.01	2,99	●
711-32	2	51,0	2.59	66	3000	21,0	28	710	2.75	4,09	●

- See Section C for Parkrimp Assembly Instructions.
- Temperature Range of other media listed in Section E.

HYDRAULIC

351TC/ST



351TC – Braided construction offering 4000 psi is more flexible than its standard spiral counterpart.

- Specifically engineered TC and ST covers prolong hose life and minimize downtime
- 4000 psi constant working pressure in all sizes
- Exceeds SAE 100R19, J517 specifications



351TC

Hydraulic – Tough Cover

SAE 100R19, J517 – Constant Working Pressure



351ST

Hydraulic – Super Tough Cover

SAE 100R19, J517 – Constant Working Pressure



Application: Petroleum base hydraulic fluids and lubricating oils.

Inner Tube: Synthetic rubber.

Reinforcement: Two braids steel wire.

Cover: Synthetic rubber abrasion resistant, MSHA accepted.

Temperature Range: -40°F to +212°F (-40°C to +100°C).

Fittings: 43 Series - pg. B-27.

# Part Number	Hose I.D.		Hose O.D.		Working Pressure		Minimum Bend Radius		Weight		Parkrimp 43 Series
	inch	mm	inch	mm	psi	MPa	inch	mm	lbs/ft	kg/m	
351TC/ST-4	1/4	6,3	.51	13	4000	28	2	50	0.20	0,30	●
351TC/ST-6	3/8	10	.67	17	4000	28	2-1/2	65	0.28	0,42	●
351TC/ST-8	1/2	12,5	.80	20	4000	28	3-1/2	90	0.35	0,52	●
351TC/ST-10	5/8	16	.93	24	4000	28	4	100	0.44	0,66	●
351TC/ST-12	3/4	19	1.09	28	4000	28	4-3/4	120	0.58	0,86	●

- See Section C for Parkrimp Assembly Instructions.
- Temperature Range of other media listed in Section E.

HYDRAULIC

722TC / ST



722TC hose was designed for high performance. Its resilient 4-wire spiral construction and Parker’s leading Tough Cover® provide unmatched application usage. 722TC hose provides SAE 100R12 performance enabling its use in a wide variety of applications. It is also one-half the bend radius of SAE 100R12 hose, making it easy to install and reducing the amount of hose needed and its synthetic rubber inner tube provides a wider range of fluid compatibility.

- Half the bend radius of SAE 100R12 hose, reducing the amount of hose needed to make your connection
- 4-spiral construction for longer lasting hose in high impulse, heavy duty cycle applications
- SAE 100R12 performance to cover a wide variety of applications
- Synthetic rubber inner tube provides a wider range of fluid compatibility
- TC cover provides 80 times the abrasion resistance compared to standard rubber cover hose
- ST cover provides 450 times the abrasion resistance compared to standard rubber cover hose
- Compatible with 43 and 71 Series fittings, providing the broadest offering of end configurations in steel and stainless steel.

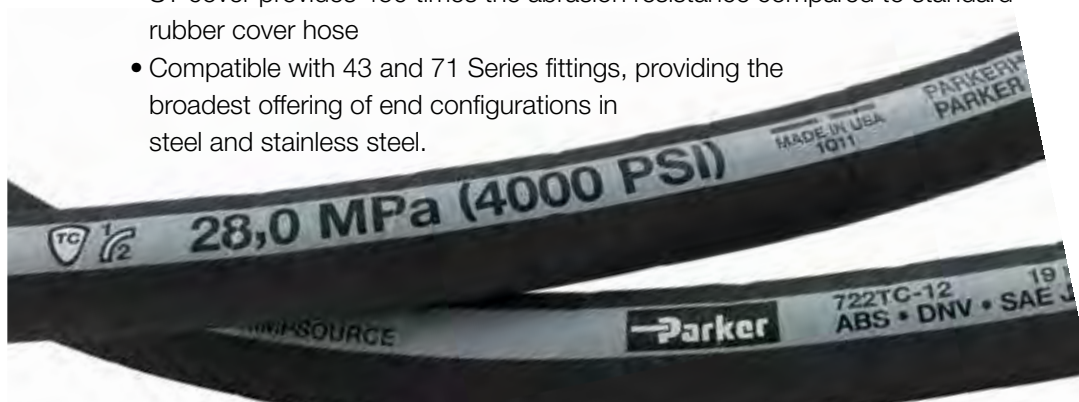

722TC / ST

Hydraulic – Tough Cover

SAE 100R12, J1942 / ISO 3862-1 TYPE R12 / TYPE R12 / USCG HF / DNV / ABS



Application: Petroleum based hydraulic fluids, lubricating oils.
Inner Tube: Synthetic rubber.
Reinforcement: Four spiral steel wire.
Cover: Synthetic rubber, MSHA accepted.
Temperature Range: -40°F to +257°F (-40°C to 125°C).
Fittings: 43 Series, sizes -6 to -20 - pg. B-27.
 71 Series, size -24 to -32 - pg. B-71.

# Part Number	Hose I.D.		Hose O.D.		Working Pressure		Minimum Bend Radius		Weight		Parkrimp 43 Series	Parkrimp 71 Series
	inch	mm	inch	mm	psi	MPa	inch	mm	lbs/ft	kg/m		
722TC/ST-6	3/8	10	0.80	20	4000	28,0	2-1/2	65	0.40	0,60	•	
722TC/ST-8	1/2	12,5	0.93	24	4000	28,0	3-1/2	90	0.54	0,80	•	
722TC/ST-10	5/8	16	1.06	27	4000	28,0	4	100	0.74	1,10	•	
722TC/ST-12	3/4	19	1.21	31	4000	28,0	4-3/4	120	0.94	1,40	•	
722TC/ST-16	1	25	1.50	38	4000	28,0	6	150	1.34	1,99	•	
722TC/ST-20	1-1/4	31,4	1.84	46	3000	21,0	8-1/4	210	1.74	2,59	•	
722TC/ST-24	1-1/2	38	2.07	53	2500	17,5	10	250	2.01	2,99		•
722TC/ST-32	2	51	2.59	66	2500	17,5	12-1/2	320	2.75	4,09		•

- See Section C for Parkrimp Assembly Instructions.
- Temperature Range of other media listed in Section E.

HYDRAULIC

772TC/ST



Durable four-spiral construction with synthetic rubber inner tube providing a wider range of fluid compatibility.

- Synthetic rubber inner tube provides a wider range of fluid compatibility
- Meets SAE 100R12 specifications

772TC

Hydraulic – Tough Cover

SAE 100R12, J1942 / ISO 3862-1 TYPE R12 / EN 856 TYPE R12 / USCG HF / DNV / ABS



772ST

Hydraulic – Super Tough Cover

SAE 100R12 / ISO 3862-1 TYPE R12 / EN 856 TYPE R12



Application: Petroleum base hydraulic fluids and lubricating oils.

Inner Tube: Synthetic rubber.

Reinforcement: Four spiral steel wire.

Cover: Synthetic rubber abrasion resistant, MSHA accepted.

Temperature Range: -40°F to +257°F (-40°C to +125°C).

Fittings: 71 Series - pg. B-71.

# Part Number	Hose I.D.		Hose O.D.		Working Pressure		Minimum Bend Radius		Weight		Parkrimp 71 Series
	inch	mm	inch	mm	psi	MPa	inch	mm	lbs/ft	kg/m	
772TC/ST-6	3/8	10	0.79	20	4000	28,0	5	125	0.40	0,60	●
772TC/ST-8	1/2	12,5	0.94	24	4000	28,0	7	180	0.62	0,93	●
772TC/ST-10	5/8	16	1.08	27	4000	28,0	8	200	0.74	1,10	●
772TC/ST-12	3/4	19	1.21	31	4000	28,0	9-1/2	240	0.94	1,40	●
772TC/ST-16	1	25	1.50	38	4000	28,0	12	300	1.34	1,99	●
772TC/ST-20	1-1/4	31,5	1.84	46	3000	21,0	16-1/2	420	1.74	2,59	●
772TC/ST-24	1-1/2	38	2.07	53	2500	17,5	20	500	2.01	2,99	●
772TC/ST-32	2	51	2.59	66	2500	17,5	25	630	2.75	4,09	●

- See Section C for Parkrimp Assembly Instructions.
- Temperature Range of other media listed in Section E.

HYDRAULIC

721, 721TC



The Parker 721 family of hoses pushes the envelope in high-pressure applications where space is tight. Critical high-pressure applications in limited spaces calls for 721 hose. With its one-half SAE 100R12 minimum bend radius and abrasion resistant cover offering, 721 hose enables you to use less hose while guarding against hose-to-hose and hose-to-object abrasion. No matter how demanding the environment, 721 hose will keep your equipment working hard.

- One-half SAE 100R12 minimum bend radius means you use less hose
- Specially engineered Tough Cover compound resists abrasion in aggressive environments
- Up to 4000 psi working pressure
- Unique three-color layline makes hose easy to identify

721

Hydraulic

SAE 100R12 / ISO 3862-1 TYPE R12 / EN 856 TYPE R12



721TC

Hydraulic – Tough Cover

SAE 100R12, J1942 / ISO 3862-1 TYPE R12 / EN 856 TYPE R12 / USCG HF / DNV / ABS



Application: Petroleum base hydraulic fluids and lubricating oils.
Inner Tube: Synthetic rubber.
Reinforcement: Four spiral steel wire.
Cover: Synthetic rubber abrasion resistant, MSHA accepted.
Temperature Range: -40°F to +257°F (-40°C to +125°C).
Fittings: 71 Series - pg. B-71.

# Part Number	Hose I.D.		Hose O.D.		Working Pressure		Minimum Bend Radius		Weight		Parkrimp 71 Series
	inch	mm	inch	mm	psi	MPa	inch	mm	lbs/ft	kg/m	
721/721TC-6	3/8	10	0.80	20	4000	28,0	2-1/2	62,5	0.40	0,60	●
721/721TC- 8	1/2	12,5	0.93	24	4000	28,0	3-1/2	90	0.62	0,93	●
721/721TC-10	5/8	16	1.08	27	4000	28,0	4	100	0.74	1,10	●
721/721TC-12	3/4	19	1.21	31	4000	28,0	4-3/4	120	0.94	1,40	●
721/721TC-16	1	25	1.50	38	4000	28,0	6	150	1.34	1,99	●
721/721TC-20	1-1/4	31,5	1.84	46	3000	21,0	8-1/4	210	1.74	2,59	●
721/721TC-24	1-1/2	38	2.07	53	2500	17,5	10	250	2.01	2,99	●
721/721TC-32	2	51	2.59	66	2500	17,5	12-1/2	320	2.75	4,09	●

- See Section C for Parkrimp Assembly Instructions.
- Temperature Range of other media listed in Section E.

HYDRAULIC

721ST

A



The Parker 721 family of hoses pushes the envelope in high-pressure applications where space is tight. Critical high-pressure applications in limited spaces calls for 721 hose. With its one-half SAE 100R12 minimum bend radius and abrasion resistant cover offering, 721 hose enables you to use less hose while guarding against hose-to-hose and hose-to-object abrasion. No matter how demanding the environment, 721 hose will keep your equipment working hard.

- One-half SAE 100R12 minimum bend radius means you use less hose
- Specially engineered Tough Cover compound resists abrasion in aggressive environments
- Up to 4000 psi working pressure
- Unique three-color layline makes hose easy to identify



721ST
Hydraulic – SuperTough Cover

SAE 100R12 / ISO 3862-1 TYPE R12 / EN 856 TYPE R12

Application: Petroleum base hydraulic fluids and lubricating oils.
Inner Tube: Synthetic rubber.
Reinforcement: Four spiral steel wire.
Cover: Synthetic rubber abrasion resistant, MSHA accepted.
Temperature Range: -40°F to +257°F (-40°C to +125°C).
Fittings: 71 Series - pg. B-71.

# Part Number	Hose I.D.		Hose O.D.		Working Pressure		Minimum Bend Radius		Weight		Parkrimp 71 Series
	inch	mm	inch	mm	psi	MPa	inch	mm	lbs/ft	kg/m	
721ST-8	1/2	12,5	0.94	24	4000	28,0	3-1/2	90	0.54	0,80	●
721ST-10	5/8	16	1.08	27	4000	28,0	4	100	0.74	1,10	●
721ST-12	3/4	19	1.21	31	4000	28,0	4-3/4	120	0.94	1,40	●
721ST-16	1	25	1.50	38	4000	28,0	6	150	1.34	1,99	●
721ST-20	1-1/4	31,5	1.84	46	3000	21,0	8-1/4	210	1.74	2,59	●

- See Section C for Parkrimp Assembly Instructions.
- Temperature Range of other media listed in Section E.

COMPACT SPIRAL™

787TC



Compared with conventional spiral hose, Parker's Compact Spiral™ 787TC Hose offers measurably greater advantages in routing and installation, product size and weight, inventory savings and much more. A world's first, this development is the most significant advancement in hydraulic hose since the introduction of Parker's No-Skive™ technology more than 25 years ago.



- Half the bend radius of SAE spiral
- One-third less effort to bend
- Nearly 30% smaller O.D. by area than SAE spiral
- Twice the impulse/life – tested to 2,000,000 cycles
- Flex impulse tested
- Constant 5000 psi across all sizes
- Less hose weight than SAE spiral



787TC

Hydraulic – Tough Cover

SAE J1754, J1942 / ISO 18752-DC / USCG HF / DNV / ABS

Application: Petroleum base hydraulic fluids and lubricating oils.

Inner Tube: Proprietary synthetic rubber.

Reinforcement: Four spiral steel wire.

Cover: Synthetic rubber, MSHA accepted.

Temperature Range:
-40°C to +125°C
(-40°F to +257°F).

Fittings: 77 Series - pg. B-96.

# Part Number	Hose I.D.		Hose O.D.		Working Pressure		Minimum Bend Radius		Weight		Parkrimp 77 Series
	inch	mm	inch	mm	psi	MPa	inch	mm	lbs/ft	kg/m	
787TC-8	1/2	12,5	0.83	21,1	5000	35,0	3-1/2	90	0.45	0,67	●
787TC-10	5/8	16	0.94	23,9	5000	35,0	4	100	0.54	0,80	●
787TC-12	3/4	19	1.10	27,9	5000	35,0	4-3/4	120	0.78	1,16	●
787TC-16	1	25	1.40	35,7	5000	35,0	6	150	1.17	1,74	●
787TC-20	1-1/4	31,5	1.77	44,9	5000	35,0	8-1/4	210	1.95	2,89	●

- See Section C for Parkrimp Assembly Instructions.
- Temperature Range of other media listed in Section E.

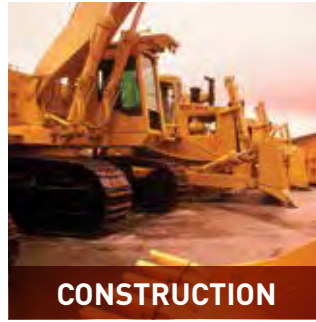

Strong like spiral.
Bends like braided.

Compact Spiral Hose has half the bend radius of its SAE counterpart and a significantly smaller bend radius than corresponding-size Parker conventional spiral hose.

In addition to maximum flexibility and excellent bendability, Parker Compact Hoses offer smaller outer diameters and abrasion resistant

cover choices. Such characteristics make them the hoses of choice for mobile hydraulic systems, agricultural machinery, forestry equipment, fork lifts, construction, machinery, injection molding, automotive, and the paper industry.

Less-bulky inner tube and outer wall construction result in up to one-third smaller Compact Spiral Hose O.D. area, enabling easier routing, hose and space savings.

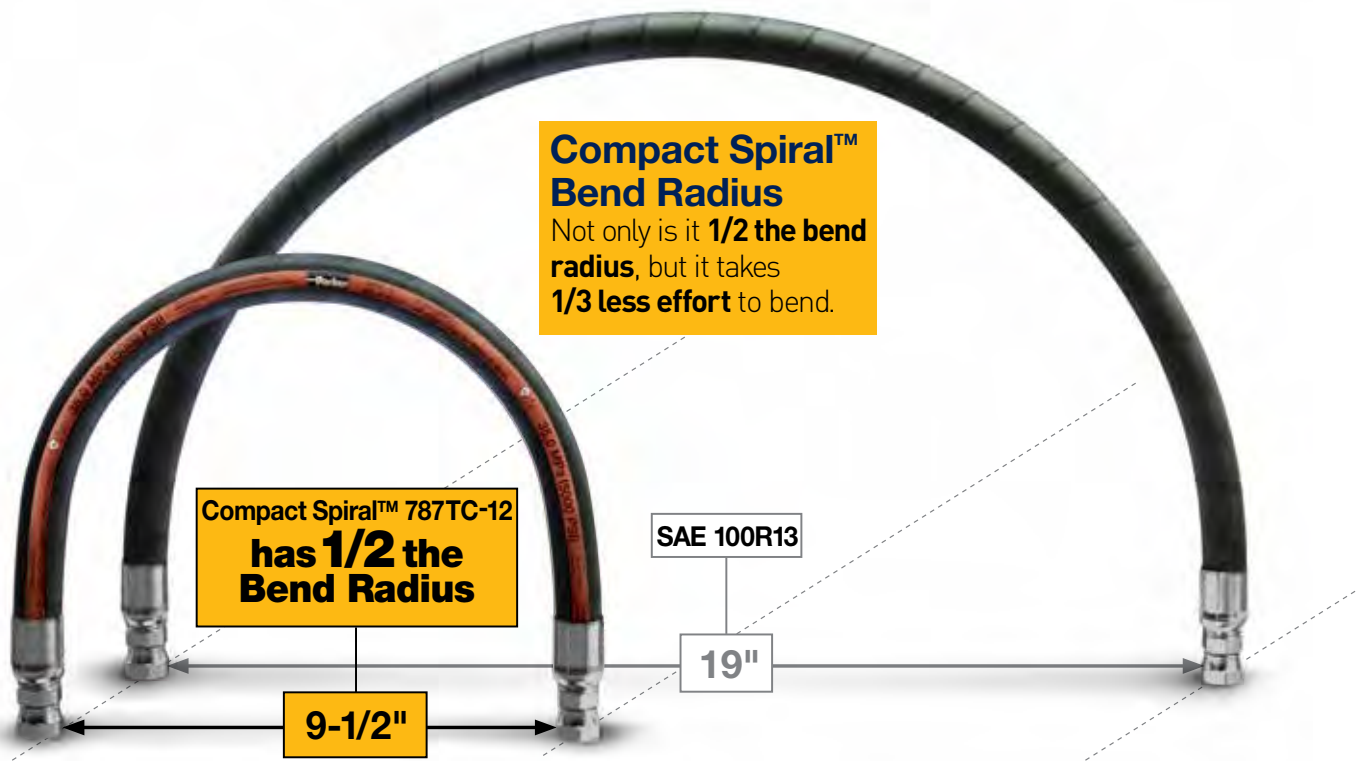

A

HYDRAULIC

781



Designed for high-pressure applications and for high-impulse, high-duty cycles.

- 4- or 6-wire spiral construction
- Constant working pressure – 5000 psi in all sizes
- Meets SAE 100R13 specifications



781 Hydraulic

SAE 100R13, J1942 / ISO 3862-1 TYPE R13 / EN856 TYPE R13 / USCG HF / DNV / ABS

Application: Petroleum base hydraulic fluids and lubricating oils.
Inner Tube: Synthetic rubber.
Reinforcement: Four or six spiral steel wire.
Cover: Synthetic rubber, MSHA accepted.
Temperature Range: -40°F to +257°F (-40°C to +125°C).
Fittings: 78 Series - pg. B-108.

# Part Number	Hose I.D.		Hose O.D.		Working Pressure		Minimum Bend Radius		Weight		Parkrimp 78 Series
	inch	mm	inch	mm	psi	MPa	inch	mm	lbs/ft	kg/m	
781-12	3/4	19	1.26	32	5000	35,0	9-1/2	240	1.07	1,59	●
781-16	1	25	1.52	39	5000	35,0	12	300	1.48	2,20	●
781-20	1-1/4	31,5	1.96	50	5000	35,0	16-1/2	420	2.48	3,69	●
781-24	1-1/2	38	2.26	57	5000	35,0	20	500	3.22	4,79	●



P35

Large-bore 2 inch size for high-pressure applications.

- Meets SAE 100R13, ISO 3862-1 Type R13 and EN 856 Type R13 specifications
- No-Skive design eliminates the need to remove the hose cover before crimping
- Approved with S6 Series fittings
- MSHA accepted cover



P35 Hydraulic

SAE 100R13, J1942 / ISO 3862-1 TYPE R13 / EN856 TYPE R13 / USCG HF / DNV / ABS / BV

Application: Petroleum base hydraulic fluids and lubricating oils.
Inner Tube: Synthetic rubber.
Reinforcement: Four or six spiral steel wire.
Cover: Synthetic rubber, MSHA accepted.
Temperature Range: -40°F to +257°F (-40°C to +125°C).
Fittings: S6 Series - pg. B-109.

# Part Number	Hose I.D.		Hose O.D.		Working Pressure		Minimum Bend Radius		Weight		Parkrimp S6 Series
	inch	mm	inch	mm	psi	MPa	inch	mm	lbs/ft	kg/m	
P35-32	2	51	2.80	71	5000	35,0	25	630	5.03	7,48	●

NOTE: P35-32 Hose must be crimped with S6 Series fittings.

- See Section C for Parkrimp Assembly Instructions.
- Temperature Range of other media listed in Section E.

HYDRAULIC

782TC/ST



Robust construction with synthetic rubber inner tube providing wider fluid compatibility.

- Synthetic rubber inner tube for wide fluid compatibility
- 5000 psi constant working pressure in all sizes
- Meets SAE 100R13 specification

782TC Hydraulic – Tough Cover

SAE 100R13, J1942 / ISO 3862-1 TYPE R13 / EN856 TYPE R13 / USCG HF / DNV / ABS / BV



782ST Hydraulic – Super Tough Cover

SAE 100R13 / ISO 3862-1 TYPE R13 / EN856 TYPE R13



Application: Petroleum base hydraulic fluids and lubricating oils.

Inner Tube: Synthetic rubber.

Reinforcement: Four or six spiral steel wire.

Cover: Synthetic rubber abrasion resistant, MSHA accepted.

Temperature Range: -40°F to +257°F (-40°C to +125°C).

Fittings: 78 Series - pg. B-108.

# Part Number	Hose I.D.		Hose O.D.		Working Pressure		Minimum Bend Radius		Weight		Parkrimp 78 Series
	inch	mm	inch	mm	psi	MPa	inch	mm	lbs/ft	kg/m	
782TC/ST-12	3/4	19	1.26	32	5000	35,0	9-1/2	240	1.07	1,59	●
782TC/ST-16	1	25	1.52	39	5000	35,0	12	300	1.48	2,20	●
782TC/ST-20	1-1/4	31,5	1.96	50	5000	35,0	16-1/2	420	2.48	3,69	●
782TC/ST-24	1-1/2	38	2.26	57	5000	35,0	20	500	3.22	4,79	●

- See Section C for Parkrimp Assembly Instructions.
- Temperature Range of other media listed in Section E.

COMPACT SPIRAL™

797TC



Compared with conventional spiral hose, Parker's Compact Spiral™ 797TC Hose offers measurably greater advantages in routing and installation, product size and weight, inventory savings and much more. A world's first, this development is the most significant advancement in hydraulic hose since the introduction of Parker's No-Skive™ technology more than 25 years ago.



- Half the bend radius of SAE spiral
- One-third less effort to bend
- Nearly 30% smaller O.D. by area than SAE spiral
- Twice the impulse/life – tested to 2,000,000 cycles
- Flex impulse tested
- Constant 6000 psi across all sizes
- Less hose weight than SAE spiral

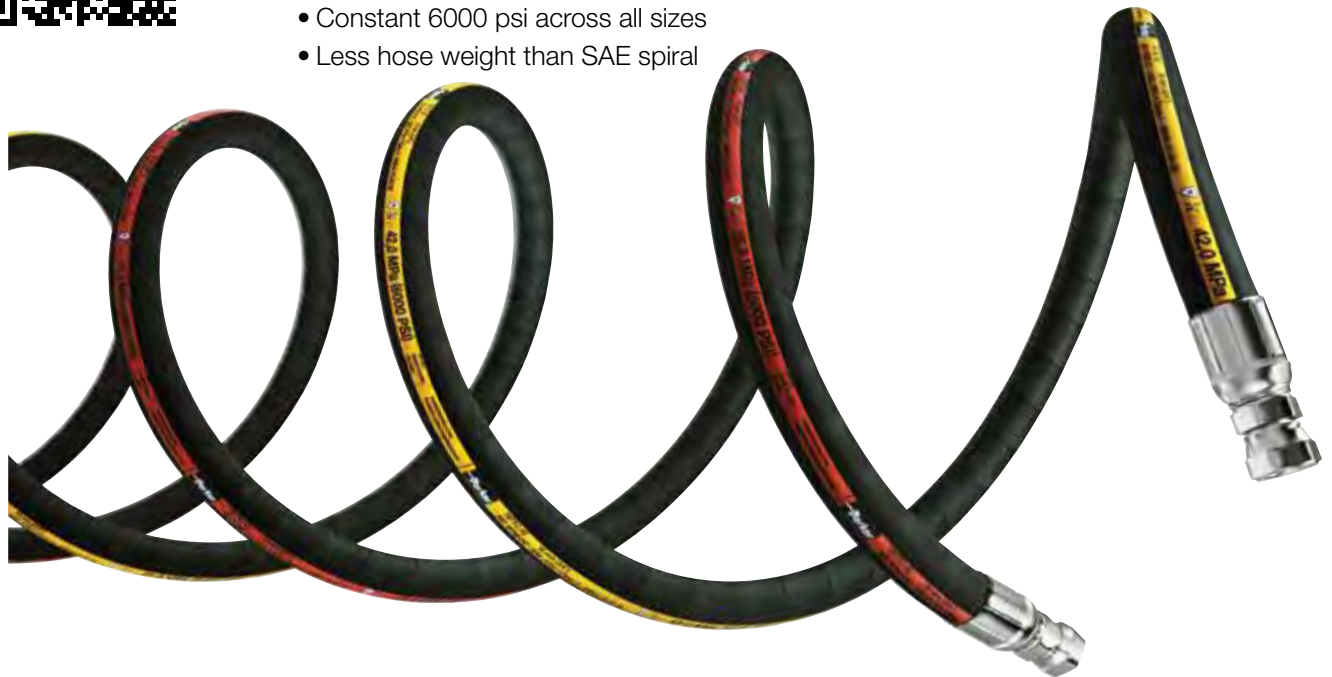

797TC

Hydraulic – Tough Cover

SAE J1754, J1942 / ISO 18752-DC / USCG HF / DNV / ABS



Application: Petroleum base hydraulic fluids and lubricating oils.
Inner Tube: Proprietary synthetic rubber.
Reinforcement: Four spiral steel wire.
Cover: Synthetic rubber, MSHA accepted.
Temperature Range: -40°C to +125°C (-40°F to +257°F).
Fittings: 77 Series - pg. B-96.

# Part Number	Hose I.D.		Hose O.D.		Working Pressure		Minimum Bend Radius		Weight		Parkrimp 77 Series
	inch	mm	inch	mm	psi	MPa	inch	mm	lbs/ft	kg/m	
797TC-8	1/2	12,5	0.83	21,1	6000	42,0	4	100	0.45	0,67	●
797TC-10	5/8	16	0.94	23,9	6000	42,0	4-1/2	100	0.54	0,80	●
797TC-12	3/4	19	1.10	27,9	6000	42,0	5-1/4	135	0.78	1,16	●
797TC-16	1	25	1.40	35,7	6000	42,0	6-1/2	165	1.17	1,74	●
797TC-20	1-1/4	31,5	1.77	44,9	6000	42,0	8-3/4	225	1.95	2,89	●

- See Section C for Parkrimp Assembly Instructions.
- Temperature Range of other media listed in Section E.



Strong like spiral.
Bends like braided.

Compact Spiral Hose has half the bend radius of its SAE counterpart and a significantly smaller bend radius than corresponding-size Parker conventional spiral hose.

In addition to maximum flexibility and excellent bendability, Parker Compact Hoses offer smaller outer diameters and abrasion resistant

cover choices. Such characteristics make them the hoses of choice for mobile hydraulic systems, agricultural machinery, forestry equipment, fork lifts, construction, machinery, injection molding, automotive, and the paper industry.



Less-bulky inner tube and outer wall construction result in up to one-third smaller Compact Spiral Hose O.D. area, enabling easier routing, hose and space savings.

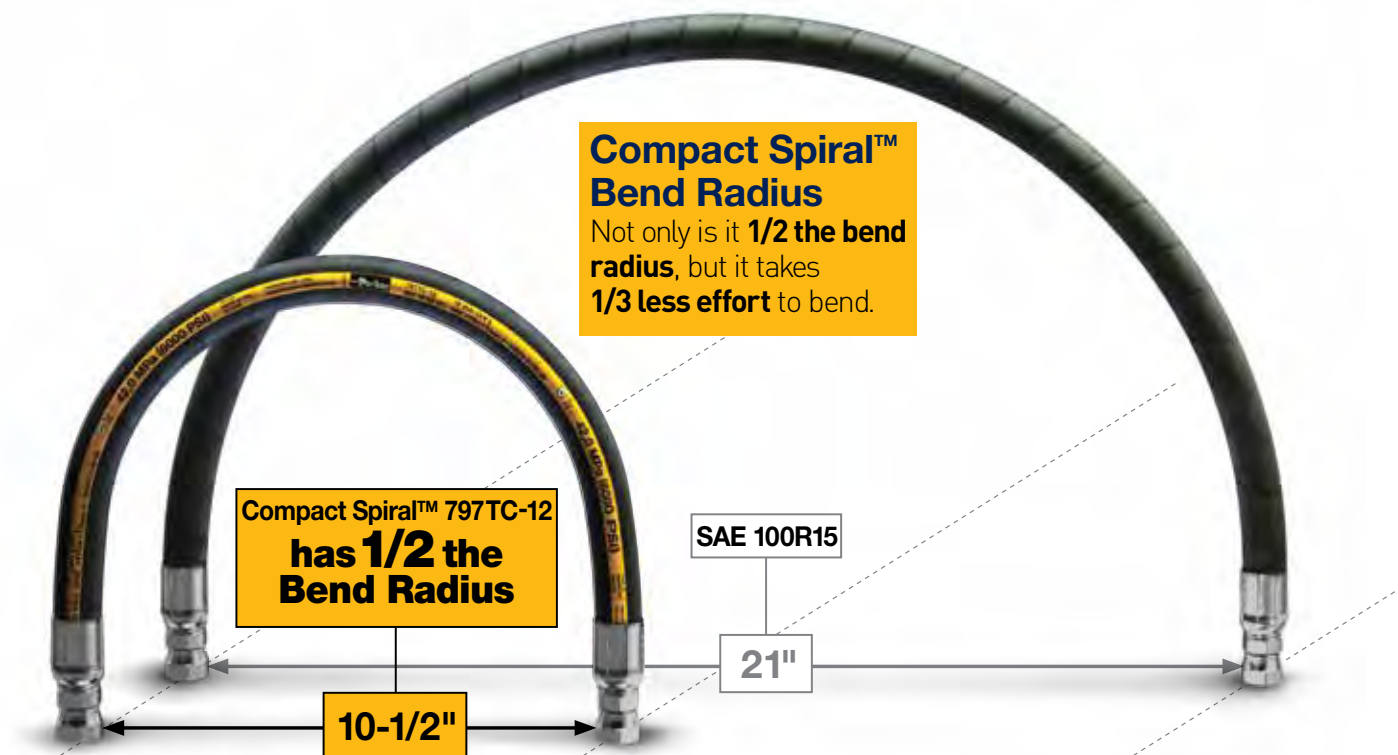

A

HYDRAULIC

791TC



Designed for up to 6000 psi high-impulse, high-duty cycle applications.

- One-half minimum bend radius
- 6000 psi constant working pressure in all sizes
- Exceeds SAE 100R15 specification

Application: Petroleum base hydraulic fluids and lubricating oils.

Inner Tube: Synthetic rubber.

Reinforcement: Four or six spiral steel wire.

Cover: Synthetic rubber abrasion resistant, MSHA accepted.

Temperature Range: -40°F to +257°F (-40°C to +125°C).

Fittings: 79 Series - pg. B-121.

791TC

Hydraulic – Extreme Tough Cover

SAE 100R15, J1942 / ISO 3862-1 TYPE R15 / USCG HF / DNV / ABS



# Part Number	Hose I.D.		Hose O.D.		Working Pressure		Minimum Bend Radius		Weight		Parkrimp 79 Series
	inch	mm	inch	mm	psi	MPa	inch	mm	lbs/ft	kg/m	
791TC-12	3/4	19	1.26	32	6000	42,0	8	200	1.07	1,59	●
791TC-16	1	25	1.52	39	6000	42,0	10	250	1.48	2,20	●
791TC-20	1-1/4	31,5	1.97	50	6000	42,0	10	250	2.48	3,69	●
791TC-24	1-1/2	38	2.28	58	6000	42,0	12	305	3.22	4,79	●



792TC/ST

Designed for up to 6000 psi high-impulse, high-duty cycle applications with a synthetic rubber inner tube providing wider fluid compatibility.

- One-half minimum bend radius
- 6000 psi constant working pressure in all sizes
- Exceeds SAE 100R15 specification

Application: Petroleum base hydraulic fluids and lubricating oils.

Inner Tube: Synthetic rubber.

Reinforcement: Four or six spiral steel wire.

Cover: Synthetic rubber abrasion resistant, MSHA accepted.

Temperature Range: -40°F to +257°F (-40°C to +125°C).

Fittings: 79 Series - pg. B-121.

792TC

Hydraulic – Tough Cover

SAE 100R15, J1942 / ISO 3862-1 TYPE R15 / USCG HF / DNV / ABS



792ST

Hydraulic – Super Tough

SAE 100R15 / ISO 3862-1 TYPE R15



# Part Number	Hose I.D.		Hose O.D.		Working Pressure		Minimum Bend Radius		Weight		Parkrimp 79 Series
	inch	mm	inch	mm	psi	MPa	inch	mm	lbs/ft	kg/m	
792TC/ST-12	3/4	19	1.26	32	6000	42,0	10-1/2	265	1.07	1,59	●
792TC/ST-16	1	25	1.52	39	6000	42,0	13	330	1.48	2,20	●

- See Section C for Parkrimp Assembly Instructions.
- Temperature Range of other media listed in Section E.

HYDRAULIC

761



Designed to provide high pressure capability for the next generation of high-pressure pumps

- 8000 psi constant working pressure in all sizes

Application: Petroleum base hydraulic fluids and lubricating oils.
Inner Tube: Synthetic rubber.
Reinforcement: Six spiral steel wire.
Cover: Synthetic rubber, MSHA accepted.
Temperature Range: -40°F to +257°F (-40°C to +125°C).
Fittings: 76 Series - pg. B-94.

761 Hydraulic – ParMax



# Part Number	Hose I.D.		Hose O.D.		Working Pressure		Minimum Bend Radius		Weight		Parkrimp 76 Series
	inch	mm	inch	mm	psi	MPa	inch	mm	lbs/ft	kg/m	
761-12	3/4	19	1.37	34,8	8000	56,0	10-1/2	260	1.56	2.32	●
761-16	1	25	1.65	41,9	8000	56,0	13	330	2.02	3.00	●



JK – Jack Hose

Parker Jack Hose should be your choice for use on hydraulically powered jacking equipment. From its engineered inner tube, and twin braids of high-tensile steel reinforcement, to its durable outer cover, our hydraulic Jack Hose has been designed for high performance, easily supporting the rigors of high tonnage hydraulic jack applications. Jack Hose comes with the added benefits of the world's largest distributor network and Parker's unequalled technical services.

- 10,500 max working pressure
- Engineered inner tube provides exceptional hydraulic fluid compatibility
- No-Skive design eliminates the need to remove hose cover before crimping

Application: Petroleum base hydraulic fluids and lubricating oils.
Inner Tube: Synthetic rubber
Reinforcement: Two braids steel wire
Cover: Synthetic rubber, MSHA accepted
Temperature Range: -40°F to +120°F (-40°C to +49°C)
Fittings: 10143-4-4, 10143-4-6, 10143-6-4, 10143-6-6 pg. B-29.

JK Hydraulic – Jack Hose



SAE 100R2 AT / ISO 1436-1 TYPE 2SN / EN 853 TYPE 2SN / 1J100,NFPA 1936

# Part Number	Hose I.D.		Hose O.D.		Working Pressure		Minimum Bend Radius		Weight		Parkrimp 43 Series
	inch	mm	inch	mm	psi	MPa	inch	mm	lbs/ft	kg/m	
JK-4	1/4	6,3	0.59	15	10500	72,4	4	100	0.26	0,39	●
JK-6	3/8	10	0.75	22	10000	70	5	125	0.37	0,55	●

NOTE: THIS PRODUCT CAN ONLY BE ASSEMBLED BY CERTIFIED DISTRIBUTORS OR CUSTOMERS ACCORDING TO THE METHODS PRESCRIBED IN BULLETIN 4480-T18-US. JK HOSE HAS A 2:1 DESIGN FACTOR.

- See Section C for Parkrimp Assembly Instructions.
- Temperature Range of other media listed in Section E.

HYDRAULIC

422



Parker's worldwide hose line is designed to accommodate global customer requirements. Manufactured to strict international specifications, 422 hose offers customers consistency of performance combined with improved availability anywhere in the world.

- One-wire braid hose design manufactured to international specifications (ISO 1436-1 Type 1SN)
- Increased working pressures for improved reliability and expanded applications versus standard SAE 100R1
- Synthetic rubber inner tube for greater fluid compatibility and bio-oil resistance
- EN853 Type 1SN



422 Hydraulic Worldwide

ISO 1436-1 TYPE 1SN/SAE 100R1 TYPE AT, J1942 / EN 853 TYPE 1SN / USCG HF / DNV / ABS

Application: Petroleum base hydraulic fluids and lubricating oils.
Inner Tube: Synthetic rubber.
Reinforcement: One braid steel wire.
Cover: Synthetic rubber.
Temperature Range: -40°F to +212°F (-40°C to +100°C).
Fittings: 43 Series - pg. B-27.
 42 Series - pg. B-173.

# Part Number	Hose I.D.		Hose O.D.		Working Pressure		Minimum Bend Radius		Weight		Vacuum Rating		Parkrimp	Field Attachable
	inch	mm	inch	mm	psi	MPa	inch	mm	lbs/ft	kg/m	of Hg	kPa	43 Series	42 Series
422-4	1/4	6,3	0.53	13	3250	22,5	4	100	0.16	0,24	24	81	•	•
422-5	5/16	6,3	0.59	15	3125	21,5	4-1/2	115	0.18	0,27	24	81	•	•
422-6	3/8	10	0.68	17	2600	18,0	5	130	0.23	0,34	24	81	•	•
422-8	1/2	12,5	0.81	21	2325	16,0	7	180	0.29	0,43	24	81	•	•
422-10	5/8	16	0.94	24	1875	13,0	8	200	0.33	0,49	24	81	•	•
422-12	3/4	19	1.09	28	1525	10,5	9-1/2	240	0.42	0,63	24	81	•	•
422-16	1	25	1.41	36	1275	8,8	12	300	0.63	0,94	24	81	•	•
422-20	1-1/4	31,5	1.79	45	900	6,3	16-1/2	420	0.8	1,19	18	61	•	•
422-24	1-1/2	38	2	51	725	5,0	20	500	1	1,49	18	61	•	•
422-32	2	51	2.54	64	575	4,0	25	630	1.5	2,24	18	61	•	•

- Field Attachable Assembly Instructions are in Section B with each Fittings Series.
- See Section C for Parkrimp Assembly Instructions.
- Temperature Range of other media listed in Section E.

HYDRAULIC

482TC/ST



Synthetic rubber inner tube provides wide fluid compatibility.

- 1/2 minimum bend radius for ease of routing
- Meets SAE 100R1 specification



482TC

Hydraulic – Tough Cover

SAE 100R1 TYPE AT, J1942 / ISO 1436-1 TYPE 1SN / EN853 TYPE 1SN / USCG H



482ST

Hydraulic – Super Tough Cover

SAE 100R1 TYPE AT / ISO 1436-1 TYPE 1SN / EN853 TYPE 1SN



Application: Petroleum base hydraulic fluids and lubricating oils.

Inner Tube: Synthetic rubber.

Reinforcement: One braided steel wire.

Cover: Synthetic rubber abrasion resistant, MSHA accepted.

Temperature Range: -40°F to +212°F (-40°C to +100°C).

Fittings: 43 Series - pg. B-27.
42 Series - pg. B-173.

# Part Number	Hose I.D.		Hose O.D.		Working Pressure		Minimum Bend Radius		Weight		Field Attachable	
	inch	mm	inch	mm	psi	MPa	inch	mm	lbs/ft	kg/m	43 Series	42 Series
482TC/ST-4	1/4	6,3	0.53	14	3250	22,7	2	50	0.16	0,24	•	•
482TC-5	5/16	8	0.59	15	3250	22,7	2-1/4	55	0.18	0,27	•	•
482TC/ST-6	3/8	10	0.69	17	3000	21,0	2-1/2	65	0.23	0,34	•	•
482TC/ST-8	1/2	12,5	0.82	21	2500	17,5	3-1/2	90	0.29	0,43	•	•
482TC/ST-10	5/8	16	0.94	24	2000	14,0	4	100	0.33	0,49	•	•
482TC/ST-12	3/4	19	1.09	28	1750	12,2	4-3/4	120	0.42	0,63	•	•
482TC/ST-16	1	25	1.41	36	1275	8,8	6	150	0.63	0,94	•	•

- Field Attachable Assembly Instructions are in Section B with each Fittings Series.
- See Section C for Parkrimp Assembly Instructions.
- Temperature Range of other media listed in Section E.

HYDRAULIC

426



Designed for high-temperature applications that can handle temperatures up to 302° F.

- Engine compartment applications
- Meets SAE 100R1 specification
- Distinctive blue cover indicates high temperature rating
- Temperature up to 302° F

426

Hydraulic – High-Temperature

SAE 100R1 TYPE AT, J1942 / USCG HF / ABS



Application: Petroleum base hydraulic fluids and lubricating oils.

Inner Tube: PKR®.

Reinforcement: One braid steel wire.

Cover: PKR® rubber, blue, MSHA accepted

Temperature Range: -50°F to +302°F (-46°C to +150°C).

Fittings: 43 Series - pg. B-27.

# Part Number	Hose I.D.		Hose O.D.		Working Pressure		Minimum Bend Radius		Weight		Parkrimp 43 Series
	inch	mm	inch	mm	psi	MPa	inch	mm	lbs/ft	kg/m	
426-4	1/4	6,3	0.53	13	2750	19,2	4	100	0.16	0,24	●
426-6	3/8	10	0.68	17	2250	15,7	5	125	0.23	0,34	●
426-8	1/2	12,5	0.81	21	2000	14,0	7	180	0.29	0,43	●
426-10	5/8	16	0.94	24	1500	10,5	8	200	0.33	0,49	●
426-12	3/4	19	1.09	28	1250	8,7	9-1/2	240	0.44	0,65	●
426-16	1	25	1.40	36	1000	7,0	12	300	0.66	0,98	●
426-20	1-1/4	31,5	1.79	45	625	4,3	16-1/2	420	0.94	1,40	●
426-24	1-1/2	38	2.00	51	500	3,5	20	500	0.98	1,46	●
426-32	2	51	2.54	64	375	2,6	25	630	1.46	2,18	●

- See Section C for Parkrimp Assembly Instructions.
- Temperature Range of other media listed in Section E.

HYDRAULIC

302



Parker's 302 hose, a universal two-wire construction hose designed to accommodate global customer requirements, is manufactured to strict international quality specifications. Parker's 302 offers customers consistency of performance combined with continuous availability anywhere in the world. It offers a high working pressure, long service life and a wide fluid compatibility.

- Universal two-wire hose design manufactured to international specifications (ISO 1436-1 Type 2SN)
- Increased working pressures for improved reliability and expanded applications
- Synthetic rubber inner tube for greater fluid compatibility and bio-oil resistance



302 Hydraulic Worldwide

ISO 1436-1 TYPE 2SN / SAE 100R2 TYPE AT, J1942 / EN 853 TYPE 2SN / USCG HF / DNV / ABS / BV



Application: Petroleum base hydraulic fluids and lubricating oils.
Inner Tube: Synthetic rubber.
Reinforcement: Two braids steel wire.
Cover: Synthetic rubber.
Temperature Range: -40°F to +212°F (-40°C to +100°C).
Fittings: 43 Series - pg. B-27.
 30 Series - pg. B-167.

# Part Number	Hose ID		Hose O.D.		Working Pressure		Minimum Bend Radius		Weight		Parkrimp 43 Series	Field Attachable 30 Series
	inch	mm	inch	mm	psi	Mpa	inch	mm	lbs/ft	kg/m		
302-4	1/4	6,3	0.59	15,0	5800	40	4	100	0.26	0,39	●	●
302-5	5/16	8	0.65	16,6	5000	35	4-1/2	115	0.28	0,42	●	●
302-6	3/8	10	0.75	19,0	4750	33	5	130	0.37	0,55	●	●
302-8	1/2	12,5	0.88	22,3	4000	28	7	180	0.45	0,67	●	●
302-10	5/8	16	1.00	25,5	3600	25	8	200	0.52	0,77	●	●
302-12	3/4	19	1.16	29,4	3100	21,5	9-1/2	240	0.67	1,00	●	●
302-16	1	25	1.50	38,1	2400	16,5	12	300	1.00	1,49	●	●
302-20	1-1/4	31,5	1.86	47,1	1800	12,5	16-1/2	420	1.16	1,73	●	●
302-24	1-1/2	38	2.14	54,5	1300	9	20	500	1.44	2,14	●	●
302-32	2	51	2.64	67,2	1150	8	25	630	1.99	2,96	●	●

- Field Attachable Assembly Instructions are in Section B with each Fittings Series.
- See Section C for Parkrimp Assembly Instructions.
- Temperature Range of other media listed in Section E.

HYDRAULIC

431



For applications with tighter routing requirements and needing a reduced bend radius, 431 features a compact construction and 1/2 minimum bend radius.

- Features a smaller O.D. for tighter routing
- Compact construction
- Half the minimum bend radius

431 Hydraulic SAE J1942 / USCG H



Application: Petroleum base hydraulic fluids and lubricating oils.
Inner Tube: Synthetic rubber.
Reinforcement: Two braids steel wire.
Cover: Synthetic rubber, MSHA accepted.
Temperature Range: -40°F to +257°F (-40°C to +125°C).
Fittings: 43 Series - pg. B-27.
 42 Series - pg. B-173.

# Part Number	Hose I.D.		Hose O.D.		Working Pressure		Minimum Bend Radius		Weight		Parkrimp 43 Series	Field Attachable 42 Series
	inch	mm	inch	mm	psi	MPa	inch	mm	lbs/ft	kg/m		
431-4	1/4	6,3	0.53	13	5000	34,5	2	50	0.18	0,27	•	
431-5	5/16	8	0.59	15	4250	29,3	2-1/4	55	0.24	0,36	•	•
431-6	3/8	10	0.68	17	4000	27,5	2-1/2	65	0.28	0,42	•	•
431-8	1/2	12,5	0.81	21	3500	24	3-1/2	90	0.34	0,51	•	•
431-10	5/8	16	0.94	24	2750	19	4	100	0.44	0,66	•	•
431-12	3/4	19	1.09	28	2250	15,5	4-3/4	120	0.54	0,80	•	•
431-16	1	25	1.41	36	2000	13,8	6	150	0.82	1,22	•	•

- Field Attachable Assembly Instructions are in Section B with each Fittings Series.
- See Section C for Parkrimp Assembly Instructions.
- Temperature Range of other media listed in Section E.

HYDRAULIC

436



With one-half the minimum SAE bend radius and a smaller hose O.D., 436 hose has the flexibility to work in almost any application – including tight spots. Engineered to withstand high pressure within a wide range of working temperatures, Parker 436 is not only versatile, but dependable over a long hose life. For quality, service and value, there’s simply no match.

- Compact construction provides easier routing
- Temperatures up to 302° F
- Distinctive blue cover indicates high temperature capability
- Reduced bend radius and excellent flexibility
- 2-wire braided reinforcement with smaller construction
- Meets SAE 100R16 / ISO 11237 Type R16 specifications

436 Hydraulic – Compact High Temperature SAE 100R16 / ISO 11237 TYPE R16



Application: Petroleum base hydraulic fluids and lubricating oils.

Inner Tube: PKR®

Reinforcement: Two braids steel wire.

Cover: PKR rubber, blue, MSHA accepted.

Temperature Range: -55°F to +302°F (-48°C to +150°C).

Fittings: 43 Series - pg. B-27.
42 Series - pg. B-173.

# Part Number	Hose I.D.		Hose O.D.		Working Pressure		Minimum Bend Radius		Weight		Parkrimp 43 Series	Field Attachable 42 Series
	inch	mm	inch	mm	psi	MPa	inch	mm	lbs/ft	kg/m		
436-6	3/8	10	0.68	17	4000	27,5	2-1/2	65	0.28	0,42	●	●
436-8	1/2	12,5	0.81	21	3500	24	3-1/2	90	0.34	0,51	●	●
436-10	5/8	16	0.94	24	2750	19	4	100	0.44	0,66	●	●
436-12	3/4	19	1.09	28	2250	15,5	4-3/4	120	0.54	0,80	●	●
436-16	1	25	1.41	36	2000	13,8	6	150	0.82	1,22	●	●

- Field Attachable Assembly Instructions are in Section B with each Fittings Series.
- See Section C for Parkrimp Assembly Instructions.
- Temperature Range of other media listed in Section E.

HYDRAULIC

471TC/ST



2-wire braided compact construction.

- Smaller O.D. for ease of installation
- Approved with 43 Series fittings
- Provides 1/2 minimum bend radius



471TC
Hydraulic – Tough Cover

SAE 100R16, J1942 / ISO 11237-1 TYPE 2SC / EN 857 TYPE 2SC / USCG HF / DNV / ABS / BV



471ST
Hydraulic – Super Tough Cover

SAE 100R16 / ISO 11237-1 TYPE 2SC / EN 857 TYPE 2SC



Application: Petroleum base hydraulic fluids and lubricating oils.

Inner Tube: Synthetic rubber.

Reinforcement: Two braids steel wire.

Cover: Synthetic rubber abrasion resistant, MSHA accepted.

Temperature Range: -40°F to +212°F (-40°C to +100°C).

Fittings: 43 Series - pg. B-27.

# Part Number	Hose I.D.		Hose O.D.		Working Pressure		Minimum Bend Radius		Weight		Vacuum Rating		Parkrimp 43 Series
	inch	mm	inch	mm	psi	MPa	inch	mm	lbs/ft	kg/m	inches of Hg	kPa	
471TC/ST-4	1/4	6,3	0.51	13	5800	40,0	2	50	0.20	0,30	28	95	●
471TC/ST-6	3/8	10	0.68	17	5000	35,0	2-1/2	65	0.28	0,42	28	95	●
471TC/ST-8	1/2	12,5	0.80	20	4250	29,7	3-1/2	90	0.35	0,52	28	95	●
471TC/ST-10	5/8	16	0.94	24	3625	25,0	4	100	0.44	0,66	28	95	●
471TC/ST-12	3/4	19	1.09	28	3125	21,5	4-3/4	120	0.58	0,86	24	80	●
471TC/ST-16	1	25	1.40	35	2500	17,5	6	150	0.79	1,17	24	80	●

For larger sizes see 472TC.

- See Section C for Parkrimp Assembly Instructions.
- Temperature Range of other media listed in Section E.

HYDRAULIC

471TC Twin Tough



Twin Tough hoses eliminate the labor and material costs required to manually bundle two separate hoses using tie straps or plastic sleeves. Plus, Parker's Twin Tough saves valuable time in the field.

- 5000 psi constant working pressure in -6-6 and 4000 psi in -8-8
- Two-wire braided construction
- Abrasion-resistant TC cover



Application: Petroleum base hydraulic fluids and lubricating oils.
Inner Tube: Synthetic rubber.
Reinforcement: Two braids steel wire.
Cover: Synthetic rubber abrasion resistant, MSHA accepted.
Temperature Range: -40°F to +212°F (-40°C to +100°C).
Fittings: 43 Series - pg. B-27.

471TC Hydraulic – Twin Tough Cover

SAE 100R16, J1942 / ISO 11237-1 TYPE 2SC / EN 857 TYPE 2SC / USCG HF / DNV / ABS / BV

# Part Number	Hose I.D.		Hose O.D.		Working Pressure		Minimum Bend Radius		Weight		Parkrimp 43 Series
	inch	mm	inch	mm	psi	MPa	inch	mm	lbs/ft	kg/m	
471TC-6-6	3/8	10	0.68	17	5000	35,0	2-1/2	65	0.56	0,84	•
471TC-8-8	1/2	12,5	0.80	20	4250	29,7	3-1/2	90	0.70	1,04	•

For assembly instructions see page C-18.



472TC

Large sizes offered for bigger jobs.

- Synthetic rubber inner tube provides wide fluid compatibility
- Available in larger sizes: -20, -24, -32
- 2-wire braided construction



Application: Petroleum base hydraulic fluids and lubricating oils.
Inner Tube: Synthetic rubber.
Reinforcement: Two braids steel wire.
Cover: Synthetic rubber abrasion resistant, MSHA accepted.
Temperature Range: -40°F to +212°F (-40°C to +100°C).
Fittings: 43 Series - pg. B-27.

472TC Hydraulic – Tough Cover

SAE J1942-1 USCG HF Type B / DNV / ABS

# Part Number	Hose I.D.		Hose O.D.		Working Pressure		Minimum Bend Radius		Weight		Parkrimp 43 Series
	inch	mm	inch	mm	psi	MPa	inch	mm	lbs/ft	kg/m	
472TC-20	1-1/4	31,5	1.79	45	2250	15,7	8-1/4	210	1.34	2,01	•
472TC-24	1-1/2	38	2.01	51	1800	12,5	10	250	1.44	2,16	•
472TC-32	2	51	2.54	65	1300	9,0	12-1/2	315	1.93	2,90	•

- See Section C for Parkrimp Assembly Instructions.
- Temperature Range of other media listed in Section E.

HYDRAULIC

AX



Designed for many markets and applications requiring a one-wire braided hose.

- 1-wire braided construction
- Approved with HY Series fittings

AX Hydraulic SAE J1942 / USCG H



Application: Petroleum base hydraulic fluids and lubricating oils.
Inner Tube: Synthetic Rubber.
Reinforcement: One braid steel wire.
Cover: Synthetic rubber, MSHA accepted.
Temperature Range: -40°F to +212°F (-40°C to +100°C).
Fittings: HY Series - pg. B-126.

# Part Number	Hose I.D.		Hose O.D.		Working Pressure		Minimum Bend Radius		Weight		Parkrimp HY Series
	inch	mm	inch	mm	psi	MPa	inch	mm	lbs/ft	kg/m	
AX04	1/4	6,3	0.50	13	3000	21	2	50	0.15	0,22	●
AX06	3/8	10	0.62	16	3000	21	2-1/2	65	0.19	0,28	●
AX08	1/2	12,5	0.75	19	2500	17,5	3-1/2	90	0.24	0,36	●
AX10	5/8	16	0.88	22	1500	10,5	4	100	0.29	0,43	●
AX12	3/4	19	1.01	26	1250	8,7	4-3/4	120	0.34	0,51	●
AX16	1	25	1.29	33	1000	7	6	150	0.48	0,72	●



BXX

Designed as a 2-wire braided option for selected pressure/temperature ranges, up to 5000 psi.

- Designed as a cost competitive option for applications not requiring industry standard specifications
- 2-wire braided construction
- Approved with HY Series fittings

BXX Hydraulic SAE J1942 / USCG H



Application: Petroleum base hydraulic fluids and lubricating oils.
Inner Tube: Synthetic rubber.
Reinforcement: Two braids steel wire.
Cover: Synthetic rubber, MSHA accepted.
Temperature Range: -40°F to +212°F (-40°C to +100°C).
Fittings: HY Series - pg. B-126.

# Part Number	Hose I.D.		Hose O.D.		Working Pressure		Minimum Bend Radius		Weight		Parkrimp HY Series
	inch	mm	inch	mm	psi	MPa	inch	mm	lbs/ft	kg/m	
BXX04	1/4	6,3	0.59	15	5000	35	4	100	0.27	0,40	●
BXX06	3/8	10	0.74	19	4000	28	5	125	0.38	0,57	●
BXX08	1/2	12,5	0.87	22	3500	24,5	7	180	0.46	0,69	●
BXX10	5/8	16	1.00	25	2750	19,2	8	200	0.55	0,82	●
BXX12	3/4	19	1.15	29	2250	15,7	9-1/2	240	0.65	0,97	●
BXX16	1	25	1.49	38	2000	14	12	305	0.98	1,46	●

- See Section C for Parkrimp Assembly Instructions.
- Temperature Range of other media listed in Section E.

HYDRAULIC

701, 731



4-wire spiral construction meeting European EN 456 4SP or 4SH standard.

- These two hoses pair together to provide a wide range of sizes for applications that need to meet European specifications

Application: Petroleum base hydraulic fluids and lubricating oils.
Inner Tube: Synthetic rubber.
Reinforcement: Four spiral steel wire.
Cover: Synthetic rubber.
Temperature Range: -40°F to +212°F (-40°C to +100°C).
Fittings: 70 Series - pg. B-61.

701 Hydraulic



SAE J1942 / ISO 3862-1 TYPE 4SP / EN 856 TYPE 4SP / USCG H, HF / ABS

# Part Number	Hose I.D.		Hose O.D.		Working Pressure		Minimum Bend Radius		Weight		Parkrimp 70 Series
	inch	mm	inch	mm	psi	MPa	inch	mm	lbs/ft	kg/m	
701-6	3/8	10	0.84	21	6500	45,0	7	180	0.52	0,78	●
701-8	1/2	12,5	0.97	25	6000	41,5	9	230	0.62	0,93	●
701-10	5/8	16	1.11	28	5000	35,0	10	250	0.77	1,15	●

731 Hydraulic



SAE J1942 / ISO 3862-1 TYPE 4SH / EN 856 TYPE 4SH / USCG HF / DVN / ABS

Application: Petroleum base hydraulic fluids and lubricating oils.
Inner Tube: Synthetic rubber.
Reinforcement: Four spiral steel wire.
Cover: Synthetic rubber.
Temperature Range: -40°F to +212°F (-40°C to +100°C).
Fittings: 73 Series - pg. B-85.

# Part Number	Hose I.D.		Hose O.D.		Working Pressure		Minimum Bend Radius		Weight		Parkrimp 73 Series
	inch	mm	inch	mm	psi	MPa	inch	mm	lbs/ft	kg/m	
731-12	3/4	19	1.27	32	6000	42,0	11	280	1.16	1,72	●
731-16	1	25	1.52	39	5500	38,0	13-1/2	340	1.44	2,14	●
731-20	1-1/4	31,5	1.79	45	4700	32,5	18	460	1.99	2,96	●
731-24	1-1/2	38	2.10	53	4200	29,0	22	560	2.15	3,20	●
731-32	2	51	2.68	68	3600	25,0	27	700	3.56	5,30	●

- See Section C for Parkrimp Assembly Instructions.
- Temperature Range of other media listed in Section E.

SUCTION & RETURN 811, 811HT, 881 Suction Line



These hoses combine to meet a wide range of suction and return application requirements.

- Up to one-half the SAE minimum bend radius for standard and high-temperature applications
- Meets or exceeds SAE 100R4 requirements
- Compatible with Parkrimp or field attachable fittings
- High-visibility layline
- Suitable for vacuum applications from 25 to 28 in/Hg
- Oil- and weather-resistant synthetic rubber cover
- High-temperature range for petroleum-based hydraulic fluids of -40° F to +257° F for 811

811 Suction and Return Line 1/2 SAE Minimum Bend Radius SAE 100R4, J1942 / USCG HF



# Part Number	Hose I.D.		Hose O.D.		Working Pressure				Minimum Bend Radius		Weight		Vacuum Rating		Parkrimp	Field Attachable
	inch	mm	inch	mm	81/88DB		88HC		inch	mm	lbs/ft	kg/m	inches of Hg	kPa	81 Series	88 Series w/HC or DB
					psi	MPa	psi	MPa								
811-12	3/4	19,0	1.18	30,0	300	2,1	100	0,7	2-1/2	64	0.42	0,63	25	84	•	•
811-16	1	25,4	1.50	38,0	250	1,7	70	0,5	3	76	0.65	0,96	25	84	•	•
811-20	1-1/4	31,8	1.77	45,0	200	1,4	50	0,3	4	102	0.82	1,22	25	84	•	•
811-24	1-1/2	38,1	2.05	52,0	150	1	50	0,3	5	127	1.04	1,55	25	84	•	•
811-32	2	50,8	2.50	63,6	100	0,7	50	0,3	6	152	1.26	1,87	25	84	•	•
811-40	2-1/2	63,5	3.00	76,2	62	0,4	62	0,4	7	178	1.64	2,45	25	84	•	•

Application: Petroleum base hydraulic fluids and lubricating oils.
Inner Tube: Synthetic rubber.
Reinforcement: Multiple layers of fiber spiral and one helical wire.
Cover: Synthetic rubber.
Temperature Range: -40°F to +212°F (-40°C to +100°C).
Fittings: 81 Series - pg. B-197.
 88 Series - pg. B-197.

- Field Attachable Assembly Instructions are in Section B with each Fittings Series.
- See Section C for Parkrimp Assembly Instructions.
- Temperature Range of other media listed in Section E.

811HT

Suction and Return Line – High-Temperature

1/2 SAE Minimum Bend Radius

SAE 100R4, J1942 / USCG HF



# Part Number	Hose I.D.		Hose O.D.		Working Pressure				Minimum Bend Radius		Weight		Vacuum Rating		Parkrimp	Field Attachable
	inch	mm	inch	mm	81/88DB		88HC		inch	mm	lbs/ft	kg/m	inches of Hg	kPa	81 Series	88 Series w/HC or DB
					psi	MPa	psi	MPa								
811HT-12	3/4	19,0	1.18	30,0	300	2,1	100	0,7	2-1/2	64	0.42	0,63	28	95	●	●
811HT-16	1	25,4	1.50	38,0	250	1,7	70	0,5	3	76	0.65	0,96	28	95	●	●
811HT-20	1-1/4	31,8	1.77	45,0	200	1,4	50	0,3	4	102	0.82	1,22	28	95	●	●
811HT-24	1-1/2	38,1	2.05	52,0	150	1	50	0,3	5	127	1.04	1,55	28	95	●	●
811HT-32	2	50,8	2.50	63,6	100	0,7	50	0,3	6	152	1.26	1,87	28	95	●	●
811HT-40	2-1/2	63,5	3,00	76,2	62	0,4	62	0,4	7	178	1.82	2,71	28	95	●	●

Application: Petroleum base hydraulic fluids and lubricating oils.
Inner Tube: Synthetic rubber.
Reinforcement: Multiple layers of fiber spiral and one helical wire.
Cover: Synthetic rubber, MSHA accepted.
Temperature Range: -50°F to +257°F (-46°C to +125°C).
Fittings: 81 Series - pg. B-197.
 88 Series - pg. B-197.

881

Suction and Return Line

SAE 100R4, J1942 / USCG H, HF



# Part Number	Hose I.D.		Hose O.D.		Working Pressure				Minimum Bend Radius		Weight		Vacuum Rating		Parkrimp	Field Attachable
	inch	mm	inch	mm	43/81/88DB		88HC		inch	mm	lbs/ft	kg/m	inches of Hg	kPa	43/81 Series	88 Series w/HC or DB
					psi	MPa	psi	Mpa								
881-12	3/4	19,0	1.20	30,6	300	2,1	100	0,7	5	127	0.50	0,74	28	95	●	●
881-16	1	25,4	1.49	37,9	250	1,7	70	0,5	6	152	0.60	0,89	28	95	●	●
881-20	1-1/4	31,8	1.78	45,3	200	1,4	50	0,3	8	203	0.89	1,32	28	95	●	●
881-24	1-1/2	38,1	2.06	52,4	150	1	50	0,3	10	254	1.11	1,65	28	95	●	●
881-32	2	50,8	2.48	63,1	100	0,7	50	0,3	12	305	1.27	1,89	28	95	●	●
881-40	2-1/2	63,5	3.00	76,2	62	0,4	62	0,4	14	356	1.82	2,71	28	95	●	●

Application: Petroleum base hydraulic fluids and lubricating oils.
Inner Tube: Synthetic rubber.
Reinforcement: Multiple layers of fiber braid and one helical wire.
Cover: Synthetic rubber, MSHA accepted.
Temperature Range: -40°F to +257°F (-40°C to +125°C).
Fittings: 43 Series - pg. B-27.
 81 Series - pg. B-197.
 88 Series - pg. B-197.

- Field Attachable Assembly Instructions are in Section B with each Fittings Series.
- See Section C for Parkrimp Assembly Instructions.
- Temperature Range of other media listed in Section E.

PUSH-LOK®

801 Multipurpose



Parker's Push-Lok Plus multipurpose hose line features the widest fluid compatibility, application range and size range in the industry. It also incorporates the highest working pressure in all sizes, making it the most versatile general-purpose hose available. The Push-Lok system is easy to use. No clamps or special tools are required during installation. And with Parker's exclusive color-code system, you can inventory, maintain and identify your hose needs easily and efficiently. The industry's most complete line of low-pressure 801, 804 hose and fittings, Push-Lok offers the range and versatility to meet all your instrumentation needs.

- Easy assembly and organization with Parker's exclusive color-code system
- Push-Lok assemblies can be made in seconds, saving valuable time and cost
- The unique seal of Push-Lok ensures reliable, durable, leak-free service



Application: Pneumatic, petroleum base hydraulic fluid, lubricating oils and antifreeze solutions.

Diesel fuel - approved only when coupled with HY Series fittings.

Inner Tube: Synthetic rubber.

Reinforcement: One fiber braid.

Cover: Synthetic rubber, MSHA accepted

Temperature Range:

Air: +158°F (+70°C)

Water: +185°F (+85°C)

Oil: -40°F to 257°F (-40°C to +125°C).

Fittings: 82 Series - pg. B-180.
HY Series - pg. B-126.

801 – Push-Lok Plus® Multipurpose

Available Cover Colors:



# Part Number	Hose I.D.		Hose O.D.		Working Pressure		Minimum Bend Radius		Weight		Vacuum Rating		Field Attachable	
	inch	mm	inch	mm	psi	MPa	inch	mm	lbs/ft	kg/m	of Hg	kPa	Parkrimp HY Series	82 Series
801-4	1/4	6,3	0.50	12,7	350	2,4	2-1/2	65	0.09	0,13	28	95	•	•
801-6	3/8	10	0.63	15,9	350	2,4	3	75	0.11	0,16	28	95	•	•
801-8	1/2	12,5	0.78	19,8	300	2,1	5	125	0.18	0,27	28	95	•	•
801-10	5/8	16	0.91	23,0	300	2,1	6	150	0.19	0,28	15	51	•	•
801-12	3/4	19	1.03	26,2	300	2,1	7	180	0.24	0,36	15	51	•	•
801-16	1	25	1.28	32,6	200	1,4	10	250	0.37	0,55	15	51	•	•

- Field Attachable Assembly Instructions are in Section B with each Fittings Series.
- Push-Lok is not recommended for any fuel, refrigerant, or for use in air conditioners and heat pump applications.
- Push-Lok is not recommended for applications where extreme pulsation is encountered.
- See Section B for Assembly Instructions.
- Temperature Range of other media listed in Section E.



A

Push-Lok Plus 801 hose provides the quick and easy assembly/disassembly advantage and the fullest range of color-coding to benefit your operations. It's now approved with both 82 Series push on and HY Series crimp fittings.

Push-Lok Plus 804 hose features quick and easy assembly and provides an EPDM inner-tube for hot water, dry air and phosphate ester fluids. Not to be used in applications with lubricated air or media that is oil based.

Push-Lok 821 is a higher-pressure multipurpose hose that is widely used for shop air systems and general industrial and maintenance

applications. Approved with 82 Series fittings, it's also available with a fire-resistant (FR) cover for use near welding operations.

Push-Lok Plus 836 delivers high-temperature up to 302° F, heat-resistant performance and higher working pressures than 821, along with the same HY and 82 Series fittings compatibility.

The color-coded advantages

In applications where a number of hose lines carry different media, Push-Lok colors reduce timely "tracing" of lines, preventing disconnection of the wrong line and unnecessary, costly downtime.

Using color-coded Push-Lok hose is an excellent way to:

- Enhance product appearance
- Improve inventory control
- Identify industrial drop lines



Inner liner is an extruded, synthetic rubber, making it resistant to petroleum-based oil, air and water.

Barbed Push-Lok fitting seals tightly, securely.

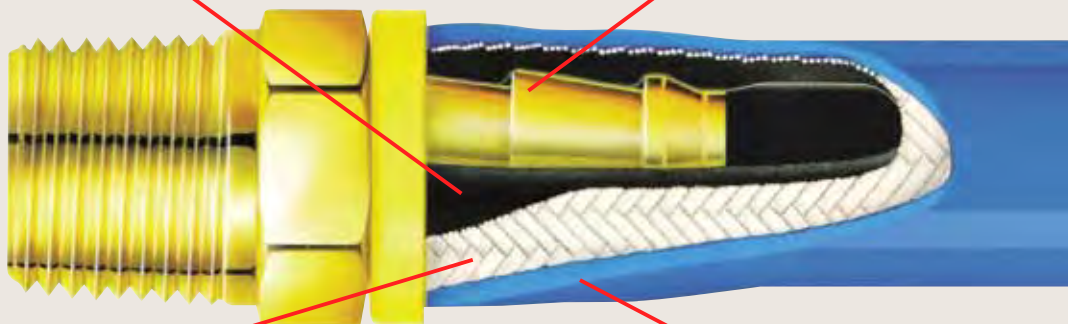

Fiber braid reinforcement layer is impregnated with synthetic rubber for added durability.

High-quality elastomer cover – lively feel, excellent flexibility and resistance to abrasion.

PUSH-LOK®

836, 804 Multipurpose

Application: Pneumatic, petroleum base hydraulic fluid, lubricating oils, diesel fuels and antifreeze solutions.

Inner Tube: PKR®.

Reinforcement: One fiber braid.

Cover: Blue neoprene or PKR, MSHA accepted.

Temperature Range:
Air: +212°F (+100°C)
Water: +185°F (+85°C)
Oil: -55°F to +302°F (-48°C to +150°C).

Diesel fuels: -40°C to 150°C (-40°F to 302°F) with HY crimps only

836 – Push-Lok Plus®
Multipurpose – High-Temperature
 Available Cover Colors: **BLU**



# Part Number	Hose I.D.		Hose O.D.		Working Pressure		Minimum Bend Radius		Weight		Vacuum Rating		Parkrimp	Field Attachable
	inch	mm	inch	mm	psi	MPa	inch	mm	lbs/ft	kg/m	of Hg	kPa	HY Series	82 Series
836-4	1/4	6,3	0.50	12,7	400	2,8	2-1/2	65	0.09	0,13	28	95	●	●
836-6	3/8	10	0.63	15,9	400	2,8	3	75	0.11	0,16	28	95	●	●
836-8	1/2	12,5	0.78	19,8	400	2,8	4	125	0.18	0,27	28	95	●	●
836-10	5/8	16	0.91	23,0	350	2,4	5	150	0.19	0,28	18	61	●	●
836-12	3/4	19	1.03	26,2	300	2,1	6	180	0.24	0,36	18	61	●	●

804
Dry Air/Hot Water
 Available Cover Colors: **BLK**



Application: Phosphate ester, dry air and water.

Inner Tube: EPDM rubber.

Reinforcement: One fiber braid.

Cover: EPDM rubber.

Temperature Range:
Air: +158°F (+70°C)
Phosphate ester: +176°F (+80°C)
Water: +200°F (+93°C).

Fittings: 82 Series - pg. B-180.

# Part Number	Hose I.D.		Hose O.D.		Working Pressure		Minimum Bend Radius		Weight		Vacuum Rating		Field Attachable
	inch	mm	inch	mm	psi	MPa	inch	mm	lbs/ft	kg/m	of Hg	kPa	82 Series
804-4	1/4	6,3	0.50	12,7	150	1,0	2-1/2	65	0.09	0,13	15	51	●
804-6	3/8	10	0.63	15,9	150	1,0	3	75	0.11	0,16	15	51	●
804-8	1/2	12,5	0.78	19,8	150	1,0	5	130	0.18	0,27	15	51	●
804-10	5/8	16	0.91	23,0	150	1,0	6	150	0.19	0,28	15	51	●
804-12	3/4	19	1.03	26,2	150	1,0	7	180	0.24	0,36	15	51	●

- Field Attachable Assembly Instructions are in Section B with each Fittings Series.
- Push-Lok is not recommended for any fuel, refrigerant, or for use in air conditioners and heat pump applications.
- Push-Lok is not recommended for applications where extreme pulsation is encountered.
- See Section B for Assembly Instructions.
- Temperature Range of other media listed in Section E.

PUSH-LOK®

821FR, 821 Multipurpose

A

Application: Pneumatic, petroleum base hydraulic fluid, lubricating oils and antifreeze solutions.

Inner Tube: PKR®.

Reinforcement: One fiber braid.

Cover: Fire resistant fiber braid.

Hose cover colors include: White, Brown, Blue, Green, and Black.

Temperature Range:

Air: +212°F (+100°C)

Water: +185°F (+85°C)

Oil: -40°F to +212°F (-40°C to +100°C).

Fittings: 82 Series - pg. B-180.

821FR

Multipurpose – Fire-Resistant Cover

Available Cover Colors: WHT BRN BLU GRN BLK



# Part Number	Hose I.D.		Hose O.D.		Working Pressure		Minimum Bend Radius		Weight		Vacuum Rating		Field Attachable 82 Series
	inch	mm	inch	mm	psi	MPa	inch	mm	lbs/ft	kg/m	inches of Hg	kPa	
821FR-4	1/4	6,3	0.50	12,7	350	2,4	2-1/2	64	0.08	0,12	28	95	●
821FR-6	3/8	10	0.63	15,9	300	2,1	3	76	0.11	0,16	28	95	●
821FR-8	1/2	12,5	0.78	19,8	300	2,1	5	127	0.12	0,18	28	95	●
821FR-12	3/4	19	1.03	26,2	250	1,7	7	178	0.22	0,33	28	95	●

Application: Pneumatic, petroleum base hydraulic fluid, lubricating oils and antifreeze solutions.

Inner Tube: Synthetic rubber.

Reinforcement: One fiber braid.

Cover: Fiber braid.

Temperature Range:

Air: +158°F (+70°C)

Water: +185°F (+85°C)

Oil: -40°F to +212°F (-40°C to +100°C).

Fittings: 82 Series - pg. B-180.

821

Multipurpose – Higher Pressures

Available Cover Colors: BLK



# Part Number	Hose I.D.		Hose O.D.		Working Pressure		Minimum Bend Radius		Weight		Vacuum Rating		Field Attachable 82 Series
	inch	mm	inch	mm	psi	MPa	inch	mm	lbs/ft	kg/m	inches of Hg	kPa	
821-4	1/4	6,3	0.50	12,7	350	2,4	2-1/2	64	0.06	0,09	28	95	●
821-6	3/8	10	0.63	15,9	300	2,1	3	76	0.09	0,13	28	95	●
821-8	1/2	12,5	0.78	19,8	300	2,1	5	127	0.12	0,18	28	95	●
821-10	5/8	16	0.91	23,0	250	1,7	6	152	0.19	0,28	28	95	●
821-12	3/4	19	1.03	26,2	250	1,7	7	178	0.21	0,31	28	95	●

- Field Attachable Assembly Instructions are in Section B with each Fittings Series.
- Push-Lok is not recommended for any fuel, refrigerant, or for use in air conditioners and heat pump applications.
- Push-Lok is not recommended for applications where extreme pulsation is encountered.
- See Section B for Assembly Instructions.
- Temperature Range of other media listed in Section E.

PHOSPHATE-ESTER 304, 774, 424, F42



If getting aircraft into the air is your job, Parker's family of phosphate-ester compatible hoses is the choice for you. Our hose selection offers the industry's largest selection of low-, medium- and high-pressure hoses specifically designed to resist aggressive airline hydraulic fluids. Parker's phosphate-ester hose line, together with the proper EPDM O-ring face seal and 37° Flare fittings and pipe adapters, means your leak-free assemblies will be the last thing you'll need to worry about.



424 hose

- Up to 1000 psi
- Dimensionally conforms to SAE 100R1 Type AT specification
- Uses Parkrimp 43 Series fittings, providing the widest selection of end configurations available anywhere

304 hose

- Up to 5000 psi
- Dimensionally conforms to SAE 100R2 Type AT specification
- Uses Parkrimp 43 Series fittings, providing the widest selection of end configurations available anywhere

774 hose

- Up to 4000 psi
- Dimensionally conforms to SAE 100R12 and EN 856 Type R12 specifications
- Uses Parkrimp 71 Series fittings

F42 hose

- 6000 psi maximum working pressure
- Compatible with phosphate ester based hydraulic fluids with a temperature range of -40°C to +80°C (-40°F to +176°F)
- Uses Parkrimp 70 / 79 Series fittings

424 Hydraulic – Phosphate-Ester Base Fluids



Application: Phosphate-ester base hydraulic fluids.
Inner Tube: EPDM rubber.
Reinforcement: One braid steel wire.
Cover: EPDM rubber, green.
Temperature Range: -40°F to +176°F (-40°C to +80°C).
Fittings: 43 Series - pg. B-27.

# Part Number	Hose I.D.		Hose O.D.		Working Pressure		Minimum Bend Radius		Weight		Vacuum Rating		Parkrimp 43 Series
	inch	mm	inch	mm	psi	MPa	inch	mm	lbs/ft	kg/m	inches of Hg	kPa	
424-16	1	25	1.40	36	1000	6,9	12	300	0.63	0,94	20	68	●
424-20	1-1/4	31,5	1.73	44	625	4,3	16-1/2	420	0.80	1,19	20	68	●
424-24	1-1/2	38	2.00	51	500	3,5	20	500	1.00	1,49	15	51	●
424-32	2	51	2.50	64	375	2,6	25	630	1.50	2,23	11	37	●

- See Section C for Parkrimp Assembly Instructions.
- Temperature Range of other media listed in Section E.

304 Hydraulic – Phosphate-Ester Base Fluids



Application: Phosphate-ester base hydraulic fluids.
Inner Tube: EPDM rubber.
Reinforcement: Two braids steel wire.
Cover: EPDM rubber, green.
Temperature Range: -40°F to +176°F (-40°C to +80°C).
Fittings: 43 Series - pg. B-27.

# Part Number	Hose I.D.		Hose O.D.		Working Pressure		Minimum Bend Radius		Weight		Parkrimp 43 Series
	inch	mm	inch	mm	psi	MPa	inch	mm	lbs/ft	kg/m	
304-4	1/4	6,3	0.59	15	5000	34,5	4	100	0.26	0,39	●
304-6	3/8	10	0.75	19	4000	27,5	5	130	0.37	0,55	●
304-8	1/2	12,5	0.88	22	3500	24	7	180	0.45	0,67	●
304-10	5/8	16	0.61	16	2750	19	8	200	0.53	0,79	●
304-12	3/4	19	1.16	29	2250	15,5	9-1/2	240	0.67	1,00	●
304-16	1	25	1.50	38	2000	13,8	12	300	1.00	1,49	●
304-20	1-1/4	31,5	1.86	47	1625	11,2	16-1/2	420	1.16	1,73	●
304-24	1-1/2	38	2.14	54	1250	8,6	20	500	1.44	2,14	●
304-32	2	51	2.64	67	1125	7,8	25	630	1.99	2,96	●

774 Hydraulic – Phosphate-Ester Base Fluids



Application: Phosphate-ester base hydraulic fluids.
Inner Tube: EPDM rubber.
Reinforcement: Four spiral steel wire.
Cover: EPDM rubber, green.
Temperature Range: -40°F to +176°F (-40°C to +80°C).
Fittings: 71 Series - pg. B-71.

# Part Number	Hose I.D.		Hose O.D.		Working Pressure		Minimum Bend Radius		Weight		Parkrimp 71 Series
	inch	mm	inch	mm	psi	MPa	inch	mm	lbs/ft	kg/m	
774-12	3/4	19	1.21	31	4000	28,0	9-1/2	240	0.94	1,40	●
774-16	1	25	1.50	38	4000	28,0	12	300	1.34	1,99	●
774-20	1-1/4	31,5	1.84	46	3000	21,0	16-1/2	420	1.74	2,59	●
774-24	1-1/2	38	2.07	53	2500	17,5	20	500	2.01	2,99	●
774-32	2	51	2.59	66	2500	17,5	25	630	2.75	4,09	●

F42 Hydraulic – Phosphate-Ester Base Fluids



Application: Phosphate-ester base hydraulic fluids.
Inner Tube: EPDM rubber.
Reinforcement: Four or six-spiral steel wire.
Cover: EPDM rubber, green.
Temperature Range: -40°F to +176°F (-40°C to +80°C).
Fittings: 70 Series - pg. B-61.
 79 Series - pg. B-121.

# Part Number	Hose I.D.		Hose O.D.		Working Pressure		Minimum Bend Radius		Weight		Parkrimp 70 Series	Parkrimp 79 Series
	inch	mm	inch	mm	psi	MPa	inch	mm	lbs/ft	kg/m	●	●
F42-8	1/2	12,5	0.97	25,0	6000	42,0	8.0	200	0.56	0,83	●	
F42-12	3/4	19	1.26	31,9	6000	42,0	10.5	265	1.03	1,53		●
F42-16	1	25	1.52	38,5	6000	42,0	13.0	330	1.40	2,08		●
F42-20	1-1/4	31,5	1.97	50	6000	42,0	17.5	445	2.66	3,96		●

- See Section C for Parkrimp Assembly Instructions.
- Temperature Range of other media listed in Section E.

LOW TEMP

301LT, 472LT, 722LT, 792LT



In extremely cold and usually remote areas, a hose burst or leak in a critical application can cause expensive downtime and possible environmental issues. Selecting the right hose for dependable, long-life performance in these applications is essential.

Parker's family of low-temperature hoses are designed specifically to excel in the brutal operating conditions of extreme cold!

- Delivers superior performance in extreme cold conditions
- Rated as low as -70°F (-57°C)
- The choice for heavy construction equipment, side booms, mining equipment, mobile equipment, arctic oil field, snow grooming equipment, snow making machinery and cold storage applications
- These No-Skive hoses use Parker's standard 43, 71 and 79 Series fittings and easy-to-use Parkrimp style crimping system



301LT Low-Temperature NO-SKIVE

SAE 100R2 TYPE A, J1942 / USCG HF / DNV / ABS



Application: Petroleum base hydraulic fluids and lubricating oils.

Inner Tube: Synthetic rubber.

Reinforcement: Two braids steel wire.

Cover: PKR Rubber.

Temperature Range: -67°F to +212°F (-55°C to +100°C).

Fittings: 43 Series - pg. B-27.

# Part Number	Hose I.D.		Hose O.D.		Working Pressure		Minimum Bend Radius		Weight		Parkrimp 43 Series
	inch	mm	inch	mm	psi	MPa	inch	mm	lbs/ft	kg/m	
301LT-4	1/4	6,3	0.59	15	5000	35,0	4	100	0.26	0,39	●
301LT-6	3/8	10	0.75	19	4000	28,0	5	130	0.37	0,55	●
301LT-8	1/2	12,5	0.88	22	3500	24,5	7	180	0.45	0,67	●
301LT-10	5/8	16	1.00	25	2750	19,2	8	200	0.52	0,77	●
301LT-12	3/4	19	1.16	29	2250	15,7	9-1/2	240	0.67	1,00	●
301LT-16	1	25	1.50	38	2000	14,0	12	300	1.00	1,49	●

- See Section C for Parkrimp Assembly Instructions.
- Temperature Range of other media listed in Section E.



A

472LT Low-Temperature Braided EN 857 Type 2SC



Application: Petroleum based hydraulic fluids and lubricating oils in low temperature conditions.

Inner Tube: Proprietary synthetic rubber compound.

Reinforcement: Two braids high tensile steel wire.

Cover: Proprietary synthetic rubber compound.

Temperature Range: -70°F to +212°F (-57°C to +100°C).

Fittings: 43 Series, sizes -4 to -16 - pg. B-27.

# Part Number	Hose I.D.		Hose O.D.		Working Pressure		Minimum Bend Radius		Weight		Parkrimp 43 Series
	inch	mm	inch	mm	psi	MPa	inch	mm	lbs/ft	kg/m	
472LT-4	1/4	6,3	0.53	13,1	5800	40,0	2	50	0.20	0,30	●
472LT-6	3/8	10	1.67	17,2	5000	35,0	2-1/2	65	0.24	0,42	●
472LT-8	1/2	12,5	1.71	20,4	4250	29,7	3-1/2	90	0.35	0,52	●
472LT-10	5/8	16	1.94	23,9	3625	25,0	4	100	0.44	0,66	●
472LT-12	3/4	19	1.09	27,7	3125	21,5	4-3/4	120	0.58	0,86	●
472LT-16	1	25	1.39	35,4	2500	17,5	6	150	0.79	1,17	●

722LT Low-Temperature Spiral SAE 100R12 / ISO 3862-1 Type R12 / EN 856 Type R12



Application: Snow grooming equipment; heavy construction equipment; sidebooms.

Inner Tube: Nitrile synthetic rubber.

Reinforcement: Four spiral steel wire.

Cover: Synthetic Rubber.

Temperature Range: -70°F to +212°F (-57°C to +100°C).

Fittings: 43 Series, sizes -6 to -20 - pg. B-27.
71 Series, size -24 - pg. B-71.

# Part Number	Hose I.D.		Hose O.D.		Working Pressure		Minimum Bend Radius		Weight		Parkrimp 43 Series	Parkrimp 71 Series
	inch	mm	inch	mm	psi	MPa	inch	mm	lbs/ft	kg/m		
722LT-6	3/8	10	0.78	19,8	4000	28,0	2-1/2	65	0.40	0,60	●	
722LT-8	1/2	12,5	0.89	22,6	4000	28,0	3-1/2	90	0.54	0,80	●	
722LT-10	5/8	16	1.04	26,4	4000	28,0	4	100	0.74	1,10	●	
722LT-12	3/4	19	1.21	30,6	4000	28,0	4-3/4	120	0.94	1,40	●	
722LT-16	1	25	1.49	37,7	4000	28,0	6	150	1.34	1,99	●	
722LT-20	1-1/4	31,4	1.82	46,2	3000	21,0	8-1/4	210	1.74	2,59	●	
722LT-24	1-1/2	38	2.06	52,5	2500	17,5	10	250	2.01	2,99		●

792LT Low-Temperature NO-SKIVE SAE / ISO - Exceeds SAE 100R15 / ISO 3862-1 Type R12 / EN



Application: Petroleum base hydraulic fluids and lubricating oils.

Inner Tube: Synthetic rubber.

Reinforcement: Four or six spiral wires, high tensile steel

Cover: PKR Rubber.

Temperature Range: -70°F to +212°F (-57°C to +100°C).

Fittings: 79 Series - pg. B-121.

# Part Number	Hose I.D.		Hose O.D.		Working Pressure		Minimum Bend Radius		Weight		Parkrimp 79 Series
	inch	mm	inch	mm	psi	MPa	inch	mm	lbs/ft	kg/m	
792LT-16	1	25	1.52	38,7	6000	42,0	11-3/4	300	1.48	2,20	●
792LT-20	1-1/4	31,5	1.97	50	6000	42,0	17-1/2	445	2.48	3,69	●
792LT-24	1-1/2	38	2.22	57	6000	42,0	20-3/4	530	3.22	4,79	●

- See Section C for Parkrimp Assembly Instructions.
- Temperature Range of other media listed in Section E.

TRANSPORTATION 293, 213, 266



Parker’s transportation hose selection has all your vehicle and equipment applications covered – with industry-leading performance and value you can count on. Meeting or exceeding specifications, Parker’s offerings are available in the sizes, pressure ratings, special designs and long-lasting durability your hydraulic or pneumatic systems demand.



293 Transportation – Air Brake Hose SAE J1402 AI / D.O.T. FMVSS 106 AI-AIR BRAKE

Application: Petroleum base hydraulic fluids and lubricating oils, diesel fuels and antifreeze solutions.
Inner Tube: PKR®.
Reinforcement: One fiber braid.
Cover: Abrasion resistant nylon fiber braid.
Temperature Range: -58°F to +302°F (-50°C to +150°C).
Fittings: 26 Series - pg. B-9.
 21 Series - pg. B-151.
 23 Series - pg. B-163.

# Part Number	Hose I.D.		Hose O.D.		Working Pressure		Minimum Bend Radius		Weight		Vacuum Rating		Parkrimp	Field Attachable
	inch	mm	inch	mm	psi	MPa	inch	mm	lbs/ft	kg/m	inches of Hg	kPa	26 Series	21/23 Series
293-4	3/16	5	0.49	12,5	500	3,5	1/2	15	0.10	0,15	28	95	●	●
293-6	5/16	8	0.62	15,7	500	3,5	1	25	0.15	0,22	28	95	●	●
293-8	13/32	10	0.74	18,7	500	3,5	1-1/2	40	0.18	0,27	28	95	●	●
293-10	1/2	12,5	0.83	21,1	450	3,1	2	50	0.20	0,30	28	95	●	●
293-12	5/8	16	0.96	24,3	450	3,1	2-1/2	65	0.22	0,33	28	95	●	●
293-16	7/8	22	1.21	30,6	450	3,1	3-1/4	80	0.25	0,37	20	68	●	●

- See Section B for Field Attachable Assembly Instructions.
- See Section C for Parkrimp Assembly Instructions.
- Temperature Range of other media listed in Section E.

TRANSPORTATION

A

213

Transportation

SAE J1402 AI / D.O.T. FMVSS 106 AI-AIR BRAKE



Application: Petroleum base hydraulic fluids and lubricating oils, diesel fuels and antifreeze solutions.

Inner Tube: PKR®.

Reinforcement: One fiber braid and one steel braid.

Cover: Fiber braid.

Temperature Range: -50°F to +302°F (-45°C to +150°C).

Fittings: 26 Series - pg. B-9.
21 Series - pg. B-151.
23 Series - pg. B-163.

# Part Number	Hose I.D.		Hose O.D.		Working Pressure		Minimum Bend Radius		Weight		Vacuum Rating		Parkrimp	Field Attachable
	inch	mm	inch	mm	psi	MPa	inch	mm	lbs/ft	kg/m	of Hg	kPa	26 Series	21/23 Series
213-4	3/16	5	0.49	12,5	2000	14	3/4	20	0.12	0,18	28	95	●	●
213-5	1/4	6,3	0.55	14	1500	10,5	1	25	0.14	0,21	28	95	●	●
213-6	5/16	8	0.62	16	1500	10,5	1-1/4	30	0.17	0,25	28	95	●	●
213-8	13/32	10	0.74	19	1250	8,7	1-3/4	45	0.20	0,30	28	95	●	●
213-10	1/2	12,5	0.83	21	1000	7	2-1/4	55	0.22	0,33	28	95	●	●
213-12	5/8	16	0.96	24	750	5,2	2-3/4	70	0.24	0,36	28	95	●	●
213-16	7/8	22	1.21	31	400	2,8	3-1/2	90	0.30	0,45	20	68	●	●
213-20	1-1/8	29	1.49	38	300	2,1	4-1/2	115	0.44	0,65	20	68	●	●
213-24	1-3/8	35	1.73	44	300	2,1	7-1/2	190	0.52	0,77	15	51	●	●
213-32	1-13/16	46	2.14	54	200	1,4	14	355	0.67	1,00	11	37	●	●
213-40*	2-3/8	61	2.88	73	175	1,2	24	610	1.31	1,95	11	64	●	●

*NOTE: Due to fitting size, this is a factory crimp only.

266

Transportation

SAE J1402 AII / D.O.T. FMVSS 106 AII-AIR BRAKE



Application: Petroleum base hydraulic fluids and lubricating oils, diesel fuels and antifreeze solutions.

Inner Tube: PKR®.

Reinforcement: One fiber braid and one steel braid.

Cover: Fiber braid.

Temperature Range: -55°F to +302°F (-48°C to +150°C).

Fittings: 26 Series - pg. 9.
20 Series - pg. B-141.
22 Series - pg. B-159.

# Part Number	Hose I.D.		Hose O.D.		Working Pressure		Minimum Bend Radius		Weight		Vacuum Rating		Parkrimp	Field Attachable
	inch	mm	inch	mm	psi	MPa	inch	mm	lbs/ft	kg/m	of Hg	kPa	26 Series	20/22 Series
266-4	3/16	5	0.52	13,2	2000	14	3/4	20	0.15	0,22	28	95	●	●
266-5	1/4	6,3	0.58	14,8	1500	10,5	1	25	0.16	0,24	28	95	●	●
266-6	5/16	8	0.68	17,2	1500	10,5	1-1/4	30	0.23	0,34	28	95	●	●
266-8	13/32	10	0.77	19,5	1250	8,7	1-3/4	45	0.26	0,39	28	95	●	●
266-10	1/2	12,5	0.92	23,4	1250	8,7	2-1/4	55	0.38	0,56	28	95	●	●
266-12	5/8	16	1.08	27,4	750	5,2	2-3/4	70	0.42	0,63	20	68	●	●
266-16	7/8	22	1.24	31,4	400	2,8	3-1/2	90	0.48	0,71	15	51	●	●
266-20	1-1/8	29	1.50	38,4	300	2,1	4-1/2	115	0.51	0,76	15	51	●	●
266-24	1-3/8	35	1.75	44,5	250	1,7	5-1/2	140	0.68	1,01	11	37	●	●

- See page E-5 for charted effects temperature has on maximum working pressures of 201, 206, 213, and 266 hose.
- See Section B for Field Attachable Assembly Instructions.
- See Section C for Parkrimp Assembly Instructions.
- Temperature Range of other media listed in Section E.

TRANSPORTATION 201, 206



201 Transportation SAE 100R5 SAE J1402 AII / D.O.T. FMVSS 106 AII-AIR BRAKE

Application: Petroleum base hydraulic fluids and lubricating oils, diesel fuels and antifreeze solutions.

Inner Tube: Synthetic rubber.

Reinforcement: One fiber braid and one steel braid.

Cover: Fiber braid.

Temperature Range: -40°F to +302°F (-40°C to +150°C).

Fittings: 26 Series - pg. B-9.
20 Series - pg. B-141.
22 Series - pg. B-159.

# Part Number	Hose I.D.		Hose O.D.		Working Pressure		Minimum Bend Radius		Weight		Vacuum Rating		Parkrimp	Field Attachable
	inch	mm	inch	mm	psi	MPa	inch	mm	lbs/ft	kg/m	of Hg	kPa		
201-4	3/16	5	0.52	13	3000	21	3	75	0.15	0,22	28	95	●	●
201-5	1/4	6,3	0.58	15	3000	21	3-3/8	85	0.18	0,27	28	95	●	●
201-6	5/16	8	0.68	17	2250	15,7	4	100	0.23	0,34	28	95	●	●
201-8	13/32	10	0.77	20	2000	14	4-1/2	115	0.27	0,40	28	95	●	●
201-10	1/2	12,5	0.92	23	1750	12,2	5-1/2	140	0.37	0,55	28	95	●	●
201-12	5/8	16	1.08	27	1500	10,5	6-1/2	165	0.40	0,60	28	95	●	●
201-16	7/8	22	1.23	31	800	5,6	7-3/8	185	0.46	0,68	20	68	●	●
201-20	1-1/8	29	1.50	38	625	4,3	9	230	0.51	0,76	20	68	●	●
201-24	1-3/8	35	1.75	44	500	3,5	10-1/2	265	0.68	1,01	15	51	●	●
201-32	1-13/16	46	2.22	56	350	2,4	13-1/4	335	0.89	1,32	11	37	●	●
201-40	2-3/8	60	2.88	73	350	2,4	24	610	1.31	1,95	11	37	●	●
201-48	3	76	3.56	90	200	1,4	33	840	2.09	3,11	11	37	●	●



206 Transportation SAE 100R5 SAE J1402 AII / D.O.T. FMVSS 106 AII-AIR BRAKE

Application: Petroleum base hydraulic fluids and lubricating oils, diesel fuels and antifreeze solutions.

Inner Tube: PKR®.

Reinforcement: One fiber braid and one steel braid.

Cover: Fiber braid, blue.

Temperature Range: -55°F to +302°F (-48°C to +150°C).

Fittings: 26 Series - pg. B-9.
20 Series - pg. B-141.
22 Series - pg. B-159.

# Part Number	Hose I.D.		Hose O.D.		Working Pressure		Minimum Bend Radius		Weight		Vacuum Rating		Parkrimp	Field Attachable
	inch	mm	inch	mm	psi	MPa	inch	mm	lbs/ft	kg/m	of Hg	kPa		
206-4	3/16	5	0.52	13	3000	21	3	75	0.15	0,22	28	95	●	●
206-5	1/4	6,3	0.58	15	3000	21	3-3/8	85	0.18	0,27	28	95	●	●
206-6	5/16	8	0.68	17	2250	15,7	3-1/2	90	0.23	0,34	28	95	●	●
206-8	13/32	10	0.77	20	2000	14	3-1/2	90	0.27	0,40	28	95	●	●
206-10	1/2	12,5	0.92	23	1750	12,2	4	100	0.37	0,55	28	95	●	●
206-12	5/8	16	1.08	27	1500	10,5	4	100	0.40	0,60	28	95	●	●
206-16	7/8	22	1.23	31	800	5,6	4	100	0.46	0,68	20	68	●	●
206-20	1-1/8	29	1.50	38	625	4,3	5-1/2	140	0.51	0,76	20	68	●	●
206-24	1-3/8	35	1.75	44	500	3,5	7-1/2	190	0.68	1,01	15	51	●	●
206-32	1-13/16	46	2.22	56	350	2,4	13-1/4	335	0.89	1,32	11	37	●	●
206-40	2-3/8	60	2.88	73	350	2,4	24	610	1.31	1,95	11	37	●	●

- See page E-5 for charted effects temperature has on maximum working pressures of 201, 206, 213, and 266 hose.
- See Section B for Field Attachable Assembly Instructions.
- See Section C for Parkrimp Assembly Instructions.
- Temperature Range of other media listed in Section E.

TRANSPORTATION 611HT



611HT Transportation SAE J517 / 100R6 EN 854 TYPE R6

Application: Petroleum base hydraulic fluids and lubricating oils, diesel fuels and antifreeze solutions.

Inner Tube: PKR®.

Reinforcement: One fiber braid.

Cover: Synthetic rubber abrasion resistant, MSHA accepted.

Temperature Range: -55°F to +302°F (-48°C to +150°C).

Fittings: HY Series - pg. B-126.

# Part Number	Hose I.D.		Hose O.D.		Working Pressure		Minimum Bend Radius		Weight		Vacuum Rating		Parkrimp HY Series
	inch	mm	inch	mm	psi	MPa	inch	mm	lbs/ft	kg/m	of Hg	kPa	
611HT-4	1/4	6,2	0,47	11,9	400	2,8	2 1/2	65	0,09	0,13	28	95	●
611HT-6	3/8	9,3	0,59	15,1	400	2,8	3	75	0,11	0,16	28	95	●
611HT-8	1/2	12,5	0,75	19,0	400	2,8	4	100	0,18	0,27	28	95	●
611HT-10	5/8	15,7	0,88	22,2	350	2,4	5	125	0,19	0,28	18	61	●
611HT-12	3/4	18,8	1,00	25,4	300	2,1	6	150	0,254	0,36	18	61	●

- See Section B for Field Attachable Assembly Instructions.
- See Section C for Parkrimp Assembly Instructions.
- Temperature Range of other media listed in Section E.

TRANSPORTATION 271 Air Brake



271 Transportation – Air Brake Hose SAE J1402 A - AIR BRAKE



Application: Air brake systems.
Inner Tube: Synthetic rubber.
Reinforcement: One or more fiber braid.
Cover: Synthetic Rubber.
Temperature Range: -50°F to +212°F (-46°C to +100°C).
Fittings: 25 Series - pg. B-5.

# Part Number	Hose I.D.		Hose O.D.		Working Pressure		Minimum Bend Radius		Weight		Parkrimp 25 Series
	inch	mm	inch	mm	psi	MPa	inch	mm	lbs/ft	kg/m	
271-6	3/8	10	0.75	19	225	1,6	1-3/4	45	0.20	0,30	•
271-8	1/2	12,5	0.88	22	225	1,6	2	50	0.26	0,39	•

- See page E-5 for charted effects temperature has on maximum working pressures of 201, 206, 213, and 266 hose.
- See Section B for Field Attachable Assembly Instructions.
- See Section C for Parkrimp Assembly Instructions.
- Temperature Range of other media listed in Section E.

ALTERNATIVE / MARINE

SS23CG



If you make or maintain LPG / CNG powered equipment, SS23CG hose is your choice for gas permeation resistance and reliable performance. SS23CG exceeds Canadian Gas Association specification CAN / CGA-8.1-M86 Type III which means it meets permeation requirements of 1,6 g/m²-day. You can specify it with confidence – anywhere.

- Meets ECE R110/R67 specification
- Meets UL21, 588, 569 specifications



Embossed layline per industry standard

SS23CG
Transportation – Compressed Natural Gas
and Liquefied Petroleum Gas
 CGA TYPE III, ECE110 CLASS 1 / UL STANDARD 21 LPG



Application: Liquefied petroleum gas (LPG), Compressed natural gas (CNG).

Inner Tube: Synthetic rubber.

Reinforcement: One steel braid.

Cover: Synthetic rubber.

Temperature Range: -40°F to +250°F (-40°C to +121°C).

Fittings: 26 Series - pg. B-9.

# Part Number	Hose I.D.		Hose O.D.		Working Pressure		Minimum Bend Radius		Weight		Parkrimp 26 Series
	inch	mm	inch	mm	psi	MPa	inch	mm	lbs/ft	kg/m	
SS23CG-6	5/16	8,0	0.68	17,2	425	3,0	4	100	0.16	0,24	●
SS23CG-8	13/32	10,0	0.77	19,5	425	3,0	4-1/2	115	0.17	0,25	●
SS23CG-10	1/2	12,5	0.92	23,4	425	3,0	5-1/2	140	0.28	0,42	●
SS23CG-12	5/8	15,9	1.05	26,8	425	3,0	6-1/2	165	0.30	0,45	●

FACTORY MADE HOSE ASSEMBLIES ONLY. Contact Hose Products Division for more information.

- See Section B for Field Attachable Assembly Instructions.
- See Section C for Parkrimp Assembly Instructions.
- Temperature Range of other media listed in Section E.

ALTERNATIVE / MARINE

SS25UL



- Low-pressure service with liquefied petroleum gas
- UL Standard 21 certification
- Oil and LPG resistant synthetic fiber cover
- Compatible with 26 Series Parkrimp style fittings



SS25UL

Transportation – Liquefied Petroleum Gas

AGA-AS / NZS 1869D / UL STANDARD 21



Application: Liquefied petroleum gas (LPG).

Inner Tube: Synthetic rubber.

Reinforcement: One fiber braid and one stainless steel wire braid.

Cover: Fiber braid.

Temperature Range: -40°F to +250°F (-40°C to +121°C).

Fittings: 26 Series - pg. B-9.
20 Series - pg. B-141.
22 Series - pg. B-159.

# Part Number	Hose I.D.		Hose O.D.		Working Pressure		Minimum Bend Radius		Weight		Parkrimp 26 Series	Field Attachable 20/22 Series
	inch	mm	inch	mm	psi	MPa	inch	mm	lbs/ft	kg/m		
SS25UL-4	3/16	5	0.52	13,2	350	2,4	0.75	20	0.11	0,16	•	•
SS25UL-5	1/4	6,3	0.58	14,8	350	2,4	1	25	0.13	0,19	•	•
SS25UL-6	5/16	8	0.68	17,2	350	2,4	1-1/4	30	0.18	0,27	•	•
SS25UL-8	13/32	10	0.77	19,5	350	2,4	1-3/4	45	0.21	0,31	•	•
SS25UL-10	1/2	12,5	0.92	23,4	350	2,4	2-1/4	55	0.29	0,43	•	•
SS25UL-12	5/8	16	1.08	27,4	350	2,4	2-3/4	70	0.37	0,55	•	•

- See Section B for Field Attachable Assembly Instructions.
- See Section C for Parkrimp Assembly Instructions.
- Temperature Range of other media listed in Section E.

ALTERNATIVE / MARINE

221FR



A fire-resistant hose for gasoline or diesel fuel systems on recreational or commercial marine vessels.

- ISO 7840 and USCG approved
- Marine fuel and engine hose



221FR

Transportation – Marine Fuel and Engine Hose

SAE J1527 TYPE A CLASS I, USCG SAE J1942 /

ISO 7840 / USCG H, HF / GERMAN LLOYD / LLOYDS REGISTER / DNV / ABS



Application: Gasoline, ethanol blends, diesel fuels, petroleum base hydraulic fluid, and lubricating oils.

Inner Tube: Synthetic rubber.

Reinforcement: One braid steel wire.

Cover: Synthetic rubber, blue, MSHA accepted.

Temperature Range: -4°F to +212°F (-20°C to +100°C).

Fittings: 26 Series - pg. B-9.
20 Series - pg. B-141.
22 Series - pg. B-159.

# Part Number	Hose I.D.		Hose O.D.		Working Pressure		Minimum Bend Radius		Weight		Vacuum Rating		Parkrimp	Field Attachable
	inch	mm	inch	mm	psi	MPa	inch	mm	lbs/ft	kg/m	of Hg	kPa	26 Series	20/22 Series
221FR-5	1/4	6,3	0.58	15	500	3,5	1	25	0.19	0,28	24	81	●	●
221FR-6	5/16	8	0.68	17	500	3,5	1-1/4	30	0.23	0,34	24	81	●	●
221FR-8	13/32	10	0.77	20	500	3,5	1-3/4	45	0.28	0,42	24	81	●	●
221FR-10	1/2	12,5	0.92	23	500	3,5	2-1/4	55	0.39	0,58	20	68	●	●
221FR-12	5/8	16	1.08	27	500	3,5	2-3/4	70	0.41	0,61	20	68	●	●
221FR-16	7/8	22	1.23	31	500	3,5	3-1/2	90	0.47	0,70	20	68	●	●

ISO 7840 with 26 Series fittings ONLY.

- See Section B for Field Attachable Assembly Instructions.
- See Section C for Parkrimp Assembly Instructions.
- Temperature Range of other media listed in Section E.

REFRIGERANT

285



Designed specifically for the rigorous requirements of bus and transit applications, Parker's refrigerant hose exceeds all requirements.

- 285 and 244HT combine to offer a wide range of sizes
- Air conditioning hose
- Excellent effusion rate
- Long service life
- Resists moisture ingress
- Parkrimp compatible

285
Refrigerant
 SAE J2064 TYPE C



Application: Refrigerant 134a.
Inner Tube: Synthetic rubber with nylon barrier.
Reinforcement: One fiber braid.
Cover: Synthetic rubber.
Temperature Range: -22°F to +257°F (-30°C to +125°C).
Fittings: 26 Series - pg. B-9.
 21 Series - pg. B-151.
 23 Series - pg. B-163.

# Part Number	Hose I.D.		Hose O.D.		Working Pressure		Minimum Bend Radius		Weight		Vacuum Rating		Parkrimp	Field Attachable
	inch	mm	inch	mm	psi	MPa	inch	mm	lbs/ft	kg/m	inches of Hg	kPa	26 Series	21/23 Series
285-4	3/16	5	0.49	11,7	500	3,4	1	25	0.09	0,14	28	95	•	•
285-6	5/16	8	0.62	15,7	500	3,4	1-1/2	40	0.12	0,18	28	95	•	•
285-8	13/32	10	0.74	18,8	500	3,4	2	50	0.17	0,25	28	95	•	•
285-10	1/2	12,5	0.83	21,1	500	3,4	2-1/2	65	0.18	0,27	28	95	•	•
285-12	5/8	16	0.96	24,4	500	3,4	3	75	0.23	0,34	28	95	•	•

- See Section B for Field Attachable Assembly Instructions.
- See Section C for Parkrimp Assembly Instructions.
- Temperature Range of other media listed in Section E.

REFRIGERANT

244



Designed specifically for the rigorous requirements of bus and transit applications, Parker's refrigerant hose exceeds all requirements.

- 244HT and 285 combine to offer a wide range of sizes
- Air conditioning hose
- Excellent effusion rate
- Long service life
- Resists moisture ingress
- Parkrimp compatible

244
Refrigerant
 SAE J2064 TYPE B, CLASS I



Application: Refrigerant 134a.
Inner Tube: Butyl rubber.
Reinforcement: One braid steel wire.
Cover: Fiber braid.
Temperature Range: -22°F to +257°F (-30°C to +125°C).
Fittings: 26 Series - pg. B-9.

# Part Number	Hose I.D.		Hose O.D.		Working Pressure		Minimum Bend Radius		Weight		Vacuum Rating		Parkrimp 26 Series
	inch	mm	inch	mm	psi	MPa	inch	mm	lbs/ft	kg/m	inches of Hg	kPa	
244-16	7/8	22	1.23	31	500	3,5	7-1/2	190	0.51	0,76	28	95	●
244-20	1-1/8	29	1.50	38	500	3,5	9	230	0.56	0,83	28	95	●
244-24	1-3/8	35	1.75	44	350	2,4	10-1/2	270	0.62	0,92	28	95	●

- See Section B for Field Attachable Assembly Instructions.
- See Section C for Parkrimp Assembly Instructions.
- Temperature Range of other media listed in Section E.

NOTES



Parkrimp (Crimp) Series
Field Attachable Series

Fittings

B



ENGINEERING YOUR SUCCESS.

Parkrimp (crimp) Series of Fittings

25 Series	B-5
26 Series	B-9
43 Series	B-27
70 Series	B-61
71 Series	B-71
73 Series	B-85
76 Series	B-94
77 Series	B-96
78 Series	B-108
S6 Series	B-109
79 Series	B-121
HY Series	B-126
81 Series	B-197

Field Attachable Series of Fittings

20 Series	B-141
21 Series	B-151
22 Series	B-159
23 Series	B-163
30 Series	B-167
42 Series	B-173
82 Series	B-180
88 Series	B-197
TB Series	B-205

A

B

C

D

E

How to Read the Fittings Section

With more than 750 end configurations, Parker's brass, stainless steel and Chromium-6 free plated steel fittings include O-ring face seal, flare, straight thread, pipe and metric designs, in both crimp and field attachable styles. Along with Parker hose, all fittings have been tested and approved, and meet stringent industry standards worldwide. Fitting page content is defined by the information shown below. Please take a moment and review.

How to Select Parkrimp Hose Fittings

- Example: 1JC43-12-8C
- 1**JC43-12-8C - Fitting (1=Crimp, 2=Field attachable, 3=Push-Lok, Blank=Nipple with clamp)
 - 1****J**C43-12-8C - End Connection
 - 1**J**C**43**-12-8C - Fitting Series
 - 1JC43-**12**-8C - Size of Fitting End Connection
 - 1JC43-12-**8**C - Hose Size
 - 1JC43-12-8**C** - Fitting Material
 - No Suffix = Steel
 - B = Brass
 - C = 316 Stainless Steel
 - BA = Brass Nipple with Steel Nut and Socket
 - BS = Brass Nipple with Brass nut and Socket
 - SM = Metric Index

Hose Inner Diameter
Measured in 1/16 inch increments identified by use of a "dash"(-) numbering system. i.e., 4/16" = 1/4" = -4.

"A" Dimension Overall Length

Hex size
Use to determine the wrench size

"B" Dimension
(Cutoff Allowance) Dimension used to determine cut length (C.L.) of hose when making a hose assembly

Catalog 4400 US
Pipe / JIC

26 Series Fittings
Use with 201, 206, 213, 221FR, 225, 244, 266, 265, 293, SS23CG hoses.

10126
Male NPTF Pipe - Rigid - Straight

Lists approved hoses for fitting series

Standard material for fittings is steel. For additional material, refer to column

# Part Number	Thread inch	Hose I.D. inch	A		H		B		Additional Material Brass
			inch	mm	inch	mm	inch	mm	
10126-2-4	1/8x27	3/16	1.65	42	7/16	0.78	0.78	20	
10126-4-4	1/4x18	3/16	1.88	48	9/16	1.01	1.01	26	
10126-4-5	1/4x18	1/4	1.88	48	9/16	1.01	1.01	26	
10126-4-6	1/4x18	5/16	1.88	48	3/4	1.02	1.02	26	•
10126-6-6	3/8x18	5/16	1.89	48	11/16	1.03	1.03	26	•
10126-6-8	3/8x18	13/32	1.89	48	11/16	1.03	1.03	26	•
10126-8-8	1/2x14	13/32	2.14	54	7/8	1.28	1.28	33	•
10126-8-10	1/2x14	1/2	2.25	57	7/8	1.30	1.30	33	•
10126-12-12	3/4x14	5/8	2.31	59	1-1/16	1.37	1.37	35	•
10126-16-16	1x11-1/2	7/8	2.61	66	1-3/8	1.57	1.57	40	
10126-20-20	1-1/4x11-1/2	1-1/8	2.83	72	1-3/4	1.77	1.77	45	
10126-24-24	1-1/2x11-1/2	1-3/8	3.01	76	2	1.93	1.93	49	
10126-32-32	2x11-1/2	1-13/16	3.44	87	2-1/2	2.18	2.18	55	

Indicates Fitting Section

Continued on next page



How to select hose fittings

To make ordering Parker products easier, we have outlined the nomenclature for hose and fittings on this page. For information on ordering hose assemblies, see Section A.

How to Select Hose

Example: 451TC-8

- 451TC-8 - Hose type
- 451TC-8 - Indicates the special feature of the hose (in this case, "Tough Cover")
- 451TC-8 - Hose inside diameter dash size (in this case, 8/16" or 1/2")



How to Select Parkrimp Hose Fittings

Example: 1JC43-12-8C

- 1JC43-12-8C - Fitting (1 = Crimp, 2 = Field Attachable, 3 = Push-Lok, Blank = Nipple with clamp or shell)
- 1JC43-12-8C - End connection (In this case, a female Seal-Lok – swivel – straight)
- 1JC43-12-8C - Fitting series
- 1JC43-12-8C - Size of fitting end connection (In this case, 12/16" or 3/4")
- 1JC43-12-8C - Hose size (In this case, 8/16" or 1/2")
- 1JC43-12-8C - Fitting material:
No Suffix = Steel
B = Brass
C = 316 Stainless Steel
BA = Brass Nipple with Steel Nut and Socket
BS = Brass Nipple with Brass Nut and Socket
SM = Metric Hex



How to Select Two-Piece Field Attachable Fittings

When selecting a two-piece field attachable fitting, the fitting part number (found in Section B of this catalog) needs to be broken down into two distinct numbers for the nipple and the socket.

Example: 20120-16-16B

Socket Part Number

Example: 20020-16B

- 20020-16B - Fitting (1 = Crimp, 2 = Field Attachable, 3 = Push-Lok, Blank = Nipple with clamp or shell)
- 20020-16B - End connection ("00" represents that it is a socket)
- 20020-16B - Fitting series
- 20020-16B - Hose size (In this case, 16/16" or 1")
- 20020-16B - Fitting material:
No Suffix = Steel
B = Brass
C = 316 Stainless Steel
BA = Brass Nipple with Steel Nut and Socket
BS = Brass Nipple with Brass Nut and Socket
SM = Metric Hex



Nipple Part Number

Example: 0120-16-16B

- _0120-16-16B - Fitting (1 = Crimp, 2 = Field Attachable, 3 = Push-Lok, Blank = Nipple with clamp or shell)
- 0120-16-16B - End connection (In this case, a male NPTF Pipe – rigid – straight)
- 0120-16-16B - Fitting series
- 0120-16-16B - Size of fitting end connection (In this case, 16/16" or 1")
- 0120-16-16B - Hose size (In this case, 16/16" or 1")
- 0120-16-16B - Fitting material:
No Suffix = Steel
B = Brass
C = 316 Stainless Steel
BA = Brass Nipple with Steel Nut and Socket
BS = Brass Nipple with Brass Nut and Socket
SM = Metric Hex



A

B

C

D

E

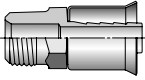
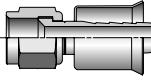
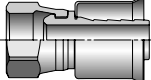
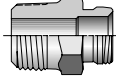
 <p>Flange</p>	<p>10125 B-6</p>  <p><i>Rigid</i></p>	<p>10825 B-6</p>  <p><i>Swivel</i></p>	<p>17B25 B-6</p>  <p><i>Swivel</i></p>	<p>017M B-6</p>  <p><i>Swivel</i></p>	<p>B-7</p> <p><i>Assembly Instructions</i></p>
--	---	--	---	---	--

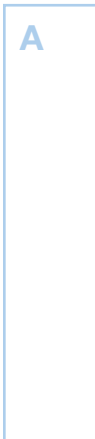

A

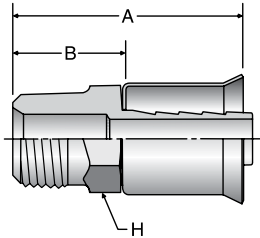

10125 Male NPTF Pipe - Rigid

# Part Number	Thread inch	Hose I.D. inch	A		H inch	B	
			inch	mm		inch	mm
10125-6-6B-VS	3/8X18	3/8	1.72	44	11/16	1.00	25
10125-6-8B-VS	3/8X18	1/2	1.72	44	11/16	1.00	25
10125-8-6B-VS	1/2X14	3/8	2.05	52	7/8	1.33	34
10125-8-8B-VS	1/2X14	1/2	2.05	52	7/8	1.33	34

B

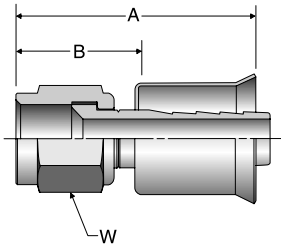

10825 Female SAE 45° - Swivel

# Part Number	Thread inch	Hose I.D. inch	A		H inch	B	
			inch	mm		inch	mm
10825-6-6B	5/8X18	3/8	1.82	46	3/4	1.10	28
10825-8-6B	3/4X16	3/8	1.80	46	7/8	1.08	27
10825-8-8B	3/4X16	1/2	1.95	50	7/8	1.22	31

C

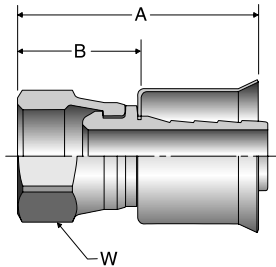

17B25 Female Air Brake Jounce Line - Swivel - Straight

# Part Number	Thread inch	Hose I.D. inch	A		H inch	B	
			inch	mm		inch	mm
17B25-8-6B	3/4X20	3/8	1.59	40	7/8	0.87	22
17B25-8-8B	3/4X20	1/2	1.59	40	7/8	0.87	22

D

017M Air Brake Adapter

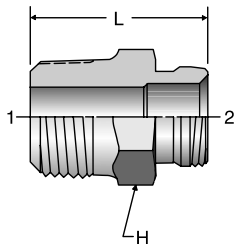

# Part Number	Thread End 1 NPTF inch		Thread End 2 UNEFinch		L		H inch
	inch	mm	inch	mm	inch	mm	
017M-6-8B	6	3/8X18	8	3/4X20	1.13	29	3/4
017M-8-8B	8	1/2X14	8	3/4X20	1.33	34	7/8

E

Assembly Instructions

1. On the 08 end configurations only, the use of a mandrel is required. This mandrel is designed to set the proper gap between the nut and the shell. To match the correct fitting with the proper mandrel part number refer to the table below.



2. The assembly mandrels can be used with a common bench vise or on the TH2-7 push-on stand. Refer to Bulletin 4480-T13-USA for push-on stand instructions.
3. When using a common bench vise, place the mandrel in the vise, put the fitting on the mandrel (nut first) then push on the hose until it bottoms. Visually check the sight hole on the side of the shell to assure that the hose is fully inserted.
4. Remove mandrel from fitting and check for proper gap between nut and shell. (See table below).
5. Now crimp the fitting onto the hose. Refer to CrimpSource for correct crimp dies and crimping dimensions.
6. Check for proper gap between nut and shell after crimp. (See table below)

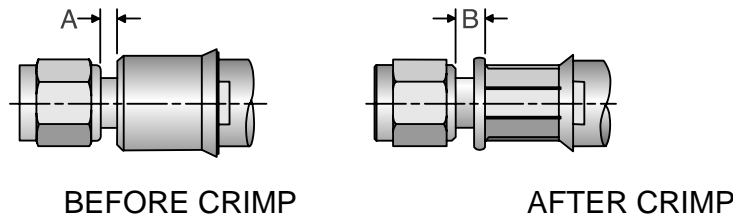

NOTE: B dimension is measured from the back of the fully-seated nut to the start of the crimp length. The nut must be free to swivel after crimping of the shell.

Fitting Part Number	A Length		B Length		Required Assembly Mandrel
	mm	inch	mm	inch	
10625-6-6B	3.80	0.150	8.00	0.315	TH2-7M25-6
10825-6-6B	5.80	0.230	11.80	0.465	
10625-8-8B	3.80	0.150	8.00	0.315	TH2-7M25-8
10825-8-8B	5.80	0.230	11.80	0.465	

NOTE: The "Required Assembly Tool" must be used to assemble all fittings listed above.

7. For all other 25 series fittings, use of mandrel is not necessary. Push fitting onto hose until it bottoms. Visually check sight hole on the side of the shell to assure that the hose is fully inserted.











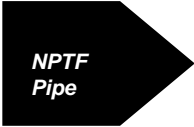
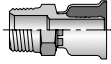

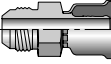
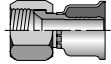
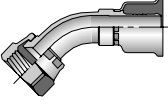
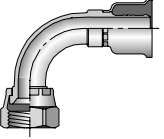
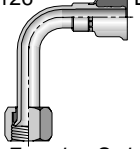
A

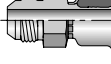
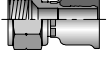
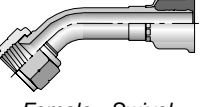
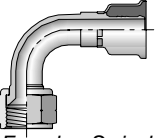
B

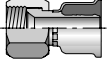
C

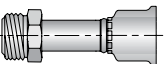
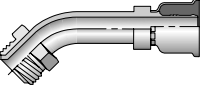
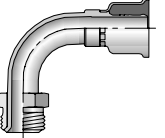
D

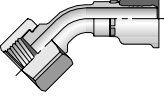
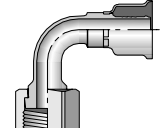
E

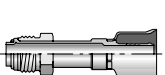
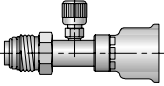
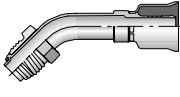
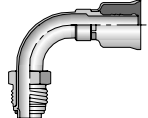
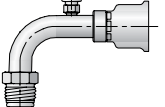
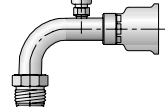
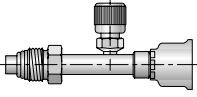
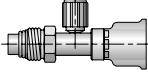
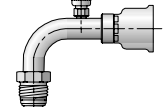
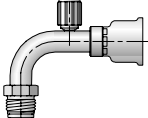
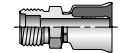
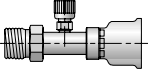
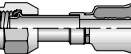
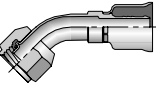
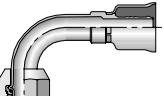
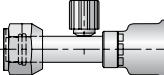
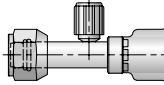
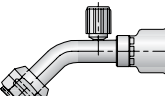
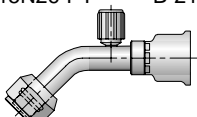
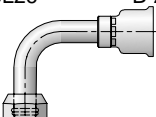
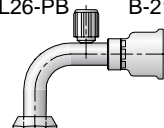
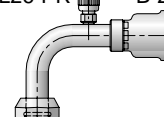
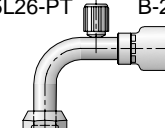
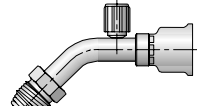
 NPTF Pipe	10126 B-11  <i>Male - Rigid</i>	 JIC 37°	10326 B-11  <i>Male - Rigid</i>	10626 B-12  <i>Female - Swivel</i>	13726 B-12  <i>Female - Swivel 45° Elbow - Short</i>
13926 B-12  <i>Female - Swivel 90° Elbow - Short</i>	14126 B-13  <i>Female - Swivel 90° Elbow - Long</i>	 SAE 45°	10426 B-13  <i>Male - Rigid</i>	10826 B-13  <i>Female - Swivel</i>	17726 B-13  <i>Female - Swivel 45° Elbow</i>
17926 B-14  <i>Female - Swivel 90° Elbow</i>	 JIC 37°/ SAE 45° Dual Flare	16826 B-14  <i>Female - Swivel</i>	 Inverted Flare	12826 B-14  <i>Male - Swivel</i>	16726 B-15  <i>Male - Swivel 45° Elbow</i>
16926 B-15  <i>Male - Swivel 90° Elbow</i>	 Seal-Lok® (O-Ring Face Seal)	1JC26 B-15  <i>Female - Swivel Short</i>	1J726 B-16  <i>Female - Swivel 45° Elbow</i>	1J926 B-16  <i>Female - Swivel 90° Elbow - Short</i>	 Tube-O
1S526 B-16  <i>Male - Swivel Short Pilot</i>	1S526-PR B-17  <i>Male - Swivel Short Pilot</i>	15R26 B-17  <i>Male - Swivel 45° Elbow - Short Pilot</i>	15K26 B-17  <i>Male - Swivel 90° Elbow - Short Pilot</i>	15K26-PB B-17  <i>Male - Swivel 90° Elbow - Short Pilot</i>	15K26-PR B-18  <i>Male - Swivel 90° Elbow - Short Pilot</i>
14526-PR B-18  <i>Male - Swivel Long Pilot</i>	14526-PT B-18  <i>Male - Swivel Long Pilot</i>	15M26-PR B-18  <i>Male - Swivel 90° Elbow - Long Pilot</i>	15M26-PT B-19  <i>Male - Swivel 90° Elbow - Long Pilot</i>	15G26 B-19  <i>Male - Rigid Internal - Long Pilot</i>	15G26-PR B-19  <i>Male - Rigid Internal - Long Pilot</i>
15S26 B-19  <i>Female - Swivel Short Pilot</i>	15H26 B-20  <i>Female - Swivel 45° Elbow - Short Pilot</i>	15T26 B-20  <i>Female - Swivel 90° Elbow - Short Pilot</i>	15926-PB B-20  <i>Female - Swivel Long Pilot</i>	15926-PT B-20  <i>Female - Swivel Long Pilot</i>	15N26-PB B-21  <i>Female - Swivel 45° Elbow - Long Pilot</i>
15N26-PT B-21  <i>Female - Swivel 45° Elbow - Long Pilot</i>	15L26 B-21  <i>Female - Swivel 90° Elbow - Long Pilot</i>	15L26-PB B-21  <i>Female - Swivel 90° Elbow - Long Pilot</i>	15L26-PR B-22  <i>Female - Swivel 90° Elbow - Long Pilot</i>	15L26-PT B-22  <i>Female - Swivel 90° Elbow - Long Pilot</i>	15P26-PT B-22  <i>Male - Swivel 45° Elbow - Long Pilot</i>

A



B

C

D

E

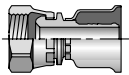
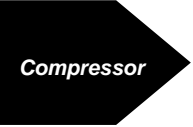
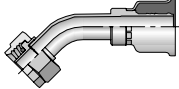
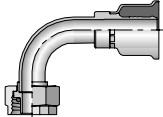
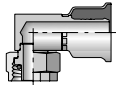
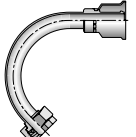
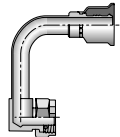
A

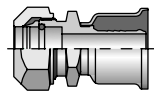
 <p>Air Brake Jounce Line</p>	<p>17B26 B-22</p>  <p><i>Female - Swivel</i></p>	 <p>Compressor</p>	<p>15V26 B-23</p>  <p><i>Female - Swivel 45° Elbow</i></p>	<p>15W26 B-23</p>  <p><i>Female - Swivel 90° Elbow</i></p>	<p>15Z26 B-23</p>  <p><i>Female - Swivel 90° Elbow - Block Type</i></p>
<p>1RV26 B-23</p>  <p><i>Female - Swivel 135° Elbow</i></p>	<p>1RZ26 B-24</p>  <p><i>Female - Swivel 180° Elbow</i></p>	 <p>Refrigerant Tube Mender</p>	<p>1T126 B-24</p>  <p><i>Male (w/Nut & Ferrule)</i></p>	<p>1T126 B-25</p> <p><i>Fitting Assembly Instructions</i></p>	

B

C

D

E

10126

Male NPTF Pipe - Rigid

# Part Number	Thread inch	Hose I.D. inch	A		H		B		Additional Material Brass (B)
			inch	mm	inch	mm	inch	mm	
10126-2-4	1/8x27	3/16	1.65	42	7/16	0.78	0.78	20	
10126-4-4	1/4x18	3/16	1.88	48	9/16	1.01	1.01	26	
10126-4-5	1/4x18	1/4	1.88	48	9/16	1.01	1.01	26	
10126-4-6	1/4x18	5/16	1.88	48	3/4	1.02	1.02	26	•
10126-6-6	3/8x18	5/16	1.89	48	11/16	1.03	1.03	26	•
10126-6-8	3/8x18	13/32	1.89	48	11/16	1.03	1.03	26	•
10126-8-8	1/2x14	13/32	2.14	54	7/8	1.28	1.28	33	•
10126-8-10	1/2x14	1/2	2.25	57	7/8	1.30	1.30	33	•
10126-12-12	3/4x14	5/8	2.31	59	1-1/16	1.37	1.37	35	•
10126-16-16	1x11-1/2	7/8	2.61	66	1-3/8	1.57	1.57	40	
10126-20-20	1-1/4x11-1/2	1-1/8	2.83	72	1-3/4	1.77	1.77	45	
10126-24-24	1-1/2x11-1/2	1-3/8	3.01	76	2	1.93	1.93	49	
10126-32-32	2x11-1/2	1-13/16	3.44	87	2-1/2	2.18	2.18	55	

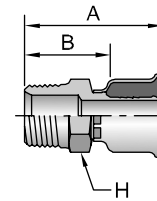

10326

Male JIC 37° - Rigid

# Part Number	Thread inch		Hose I.D. inch	A		H		B		Additional Material Brass (B)
	inch	mm		inch	mm	inch	mm			
10326-4-4	1/4	7/16x20	3/16	2.02	50	1/2	1.15	1.15	29	•
10326-6-6	3/8	9/16x18	5/16	2.12	54	3/4	1.26	1.26	32	•
10326-8-8	1/2	3/4X16	13/32	1.94	49	13/16	1.08	1.08	27	•
10326-10-10	5/8	7/8X14	1/2	2.49	64	15/16	1.54	1.54	39	•
10326-16-16	1	1-5/16x12	7/8	2.79	71	1-3/8	1.75	1.75	44	

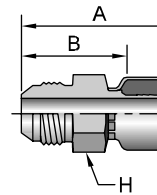

10626

Female JIC 37° - Swivel

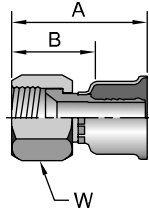

# Part Number	Thread		Hose I.D. inch	A		W inch	B		Additional Material Brass (B)
	inch	mm		inch	mm		inch	mm	
10626-6-6	3/8	9/16x18	5/16	1.81	45	11/16	0.95	23	•
10626-6-8	3/8	9/16x18	13/32	1.67	52	11/16	1.19	30	•
10626-12-12	3/4	1-1/16x12	5/8	2.29	58	1-1/4	1.35	34	•
10626-16-16	1	1-5/16x12	7/8	2.53	64	1-1/2	1.49	38	•
10626-20-20	1-1/4	1-5/8x12	1-1/8	2.56	65	2	1.50	38	•
10626-24-24	1-1/2	1-7/8x12	1-3/8	2.77	70	2-1/4	1.69	43	
10626-32-32	2	2-1/2x12	1-13/16	3.30	84	2-7/8	2.04	52	

13726

Female JIC 37° - Swivel - 45° Elbow - Short Drop

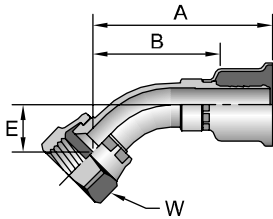

# Part Number	Thread		Hose I.D. inch	A		E		W inch	B	
	inch	mm		inch	mm	inch	mm		inch	mm
13726-4-4	1/4	7/16x20	3/16	2.01	51	0.39	10	9/16	1.14	29
13726-6-6	3/8	9/16x18	5/16	2.72	69	0.43	11	11/16	1.86	47
13726-8-8	1/2	3/4x16	13/32	2.82	72	0.55	15	7/8	1.96	50
13726-10-10	5/8	7/8x14	1/2	2.96	75	0.63	16	1	2.01	51
13726-12-12	3/4	1-1/16x12	5/8	3.44	87	0.83	21	1-1/4	2.50	63
13726-16-16	1	1-5/16x12	7/8	3.34	85	0.90	23	1-1/2	2.30	58
13726-20-20	1-1/4	1-5/8x12	1-1/8	3.74	95	1.18	30	2	2.68	68
13726-24-24	1-1/2	1-7/8x12	1-3/8	3.92	100	1.16	29	2-1/4	2.84	72

13926

Female JIC 37° - Swivel - 90° Elbow - Short Drop

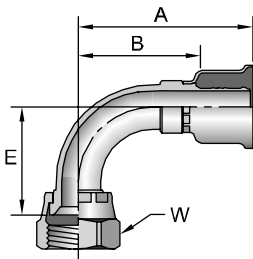

# Part Number	Thread		Hose I.D. inch	A		E		W inch	B	
	inch	mm		inch	mm	inch	mm		inch	mm
13926-4-4	1/4	7/16x20	3/16	1.82	46	0.83	21	9/16	0.95	24
13926-6-6	3/8	9/16x18	5/16	2.15	55	0.91	23	11/16	1.29	33
13926-8-8	1/2	3/4x16	13/32	2.22	56	1.09	28	7/8	1.36	35
13926-10-10	5/8	7/8x14	1/2	2.23	57	1.26	32	1	1.28	33
13926-10-12	5/8	7/8x14	5/8	2.52	64	1.23	31	1	1.58	40
13926-12-12	3/4	1-1/16x12	5/8	2.28	58	1.82	46	1-1/4	1.30	34
13926-16-16	1	1-5/16x12	7/8	3.30	84	2.14	54	1-1/2	2.26	57
13926-20-20	1-1/4	1-5/8x12	1-1/8	3.60	91	2.57	65	2	2.53	65
13926-24-24	1-1/2	1-7/8x12	1-3/8	3.92	100	2.82	72	2-1/4	2.84	72

14126

Female JIC 37° - Swivel - 90° Elbow - Long Drop

# Part Number	Thread		Hose I.D. inch	A		E		W inch	B	
	inch	inch		inch	mm	inch	mm		inch	mm
14126-4-4	1/4	7/16x20	1/4	2.05	52	1.81	46	9/16	1.18	30
14126-6-6	3/8	9/16x18	5/16	2.02	51	2.13	54	11/16	1.16	29
14126-8-8	1/2	3/4X16	13/32	2.35	60	2.43	62	7/8	1.49	38
14126-10-10	5/8	7/8x14	1/2	2.11	54	2.76	70	1	1.16	29
14126-16-16	1	1-5/16x12	7/8	3.17	81	4.33	110	1-1/2	2.13	54

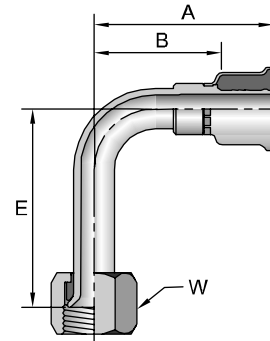

10426

Male SAE 45° - Rigid

# Part Number	Thread		Hose I.D. inch	A		H inch	B	
	inch	inch		inch	mm		inch	mm
10426-4-4	1/4	7/16x20	3/16	1.97	50	1/2	1.18	28
10426-6-6	3/8	5/8x18	5/16	2.04	52	11/16	1.18	30

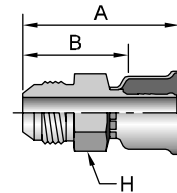

10826

Female SAE 45° - Swivel

# Part Number	Thread		Hose I.D. inch	A		W inch	B		Additional Material Brass (B)
	inch	inch		inch	mm		inch	mm	
10826-6-6	3/8	5/8x18	5/16	1.84	47	3/4	0.98	25	•
10826-10-8	5/8	7/8x14	13/32	2.21	56	1	1.35	34	
10826-10-10	5/8	7/8x14	1/2	2.13	54	1	1.18	30	
10826-12-12	3/4	1-1/16x14	5/8	2.19	56	1-1/4	1.25	32	•

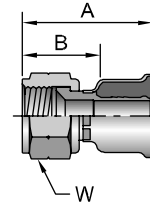

17726

Female SAE 45° - Swivel - 45° Elbow

# Part Number	Thread		Hose I.D. inch	A		E		W inch	B	
	inch	inch		inch	mm	inch	mm		inch	mm
17726-4-4	1/4	7/16x20	3/16	2.29	58	0.39	10	9/16	1.43	36
17726-6-6	3/8	5/8x18	5/16	2.72	69	0.43	11	11/16	1.86	47
17726-8-8	1/2	3/4x16	13/32	2.82	72	0.59	14	7/8	1.96	50
17726-10-10	5/8	7/8x14	1/2	2.96	75	0.63	16	1	2.01	51
17726-12-12	3/4	1-1/16x14	5/8	3.43	87	0.83	21	1-1/4	2.49	63

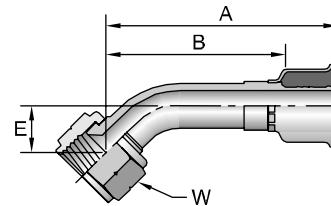

Notch on nut signifies SAE 45° flare fitting.

17926

Female SAE 45° - Swivel - 90° Elbow

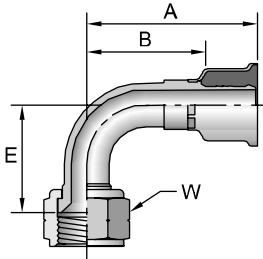

# Part Number	Thread		Hose I.D. inch	A		E		W inch	B	
	inch			inch	mm	inch	mm		inch	mm
17926-4-4	1/4	7/16x20	3/16	1.75	44	0.83	21	9/16	0.89	23
17926-6-6	3/8	5/8x18	5/16	2.15	55	0.91	23	3/4	1.29	33
17926-8-8	1/2	3/4x16	13/32	2.31	58.7	1.00	25.4	7/8	1.45	37
17926-10-10	5/8	7/8x14	1/2	2.23	57	1.26	32	1	1.28	33
17926-12-12	3/4	1-1/16x14	5/8	2.28	58	1.82	46	1-1/4	1.34	34

Notch on nut signifies 45° flare fitting.

16826

Female JIC 37° / SAE 45° - Dual Flare - Swivel

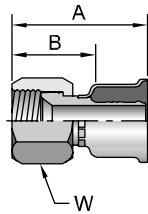

# Part Number	Thread		Hose I.D. inch	A		W inch	B		Additional Material Brass (B)
	inch			inch	mm		inch	mm	
16826-4-4	1/4	7/16x20	3/16	1.67	42	9/16	0.80	20	•
16826-4-5	1/4	7/16x20	1/4	1.55	48	9/16	1.03	26	
16826-4-6	1/4	7/16x20	5/16	1.55	39	9/16	0.07	17	
16826-5-5	5/16	1/2x20	1/4	1.77	45	5/8	0.90	23	
16826-8-6	1/2	3/4x16	5/16	1.76	56	7/8	1.34	34	
16826-8-8	1/2	3/4x16	13/32	1.91	49	7/8	1.05	27	
16826-8-10	1/2	3/4x16	1/2	2.36	60	7/8	1.41	36	•
16826-10-10	5/8	7/8x14	1/2	2.17	55	1	1.23	31	•
16826-10-12	5/8	7/8x14	5/8	1.96	61	1	1.53	37	

12826

Male Inverted SAE 45° - Swivel

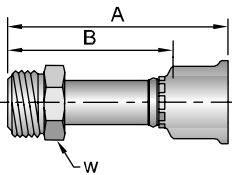

# Part Number	Thread		Hose I.D. inch	A		W inch	B	
	inch			inch	mm		inch	mm
12826-4-4	1/4	7/16x24	3/16	2.43	62	7/16	1.56	40
12826-5-5	5/16	1/2x20	1/4	2.56	65	1/2	1.69	43
12826-6-6	3/8	5/8x18	5/16	2.87	73	5/8	2.01	51
12826-8-8	1/2	3/4x18	13/32	3.00	76	3/4	2.14	54
12826-10-10	5/8	7/8x18	1/2	3.17	81	7/8	2.22	56

See Accessories Section for O-Rings and Flange Kits.

16726

Male Inverted SAE 45° - Swivel - 45° Elbow

# Part Number	Thread		Hose I.D. inch	A		E		W		B	
	inch			inch	mm	inch	mm	inch	inch	inch	mm
16726-4-4	1/4	7/16x24	3/16	2.20	56	0.63	16	7/16	1.33	34	
16726-5-5	5/16	1/2x20	1/4	2.30	58	0.70	18	1/2	1.43	36	
16726-6-6	3/8	5/8x18	5/16	2.55	65	0.87	22	5/8	1.69	43	
16726-8-8	1/2	3/4x18	13/32	2.60	66	1.09	28	3/4	1.74	44	

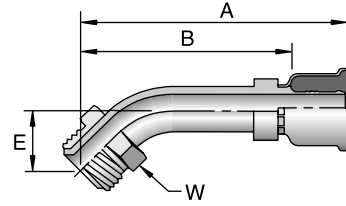

16926

Male Inverted SAE 45° - Swivel - 90° Elbow

# Part Number	Thread		Hose I.D. inch	A		E		W		B	
	inch			inch	mm	inch	mm	inch	inch	inch	mm
16926-4-4	1/4	7/16x24	3/16	2.27	58	1.56	40	7/16	1.40	36	
16926-6-6	3/8	5/8x18	5/16	1.89	48	1.48	38	5/8	1.03	26	
16926-8-8	1/2	3/4x18	13/32	2.25	57	1.88	48	3/4	1.39	35	
16926-10-10	5/8	7/8x18	1/2	2.70	69	2.17	55	7/8	1.75	44	

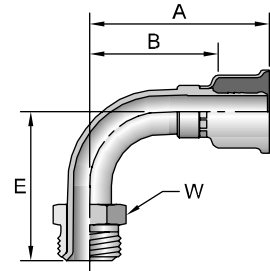

1JC26

Female Seal-Lok® - Swivel - Short

# Part Number	Thread		Hose I.D. inch	A		C		H		W		B	
	inch			inch	mm	inch	mm	inch	inch	inch	mm	inch	mm
1JC26-4-4	1/4	9/16x18	3/16	1.66	42	0.31	8	9/16	11/16	0.79	20		
1JC26-6-6	3/8	11/16x16	5/16	1.70	43	0.34	9	11/16	13/16	0.84	21		
1JC26-8-8	1/2	13/16x16	13/32	1.76	45	0.43	11	13/16	15/16	0.90	23		
1JC26-12-12	3/4	1-3/16x12	5/8	2.13	54	0.55	14	1-1/8	1-3/8	1.19	30		
1JC26-16-16	1	1-7/16x12	7/8	2.39	61	0.56	14	1-3/8	1-5/8	1.35	34		
1JC26-20-20	1-1/4	1-11/16x12	1-1/8	2.45	62	0.59	15	1-7/8	1-7/8	1.39	35		

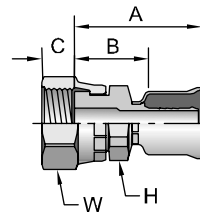

When measuring overall length to the end of the nut, B + C must be used to calculate cut-off allowance.
 See Accessories Section for O-Rings.

A

B

C

D

E

1J726

Female Seal-Lok® - Swivel - 45° Elbow

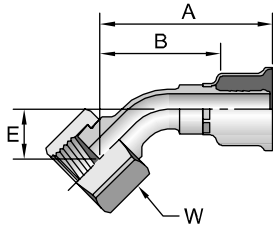

# Part Number	Thread		Hose I.D. inch	A		E		W		B	
	inch	inch		inch	mm	inch	mm	inch	mm	inch	mm
1J726-4-4	1/4	9/16x18	3/16	1.99	51	0.39	10	11/16	1.12	28	
1J726-6-6	3/8	11/16x16	5/16	2.43	62	0.43	11	13/16	1.57	40	
1J726-8-8	1/2	13/16x16	13/32	2.77	70	0.59	15	15/16	1.91	49	
1J726-10-10	5/8	1x14	1/2	3.26	83	0.63	16	1-1/8	2.31	59	
1J726-12-12	3/4	1-3/16x12	5/8	3.13	80	0.83	21	1-3/8	2.19	56	
1J726-16-16	1	1-7/16x12	7/8	3.61	92	0.94	24	1-5/8	2.57	65	
1J726-20-20	1-1/4	1-11/16x12	1-1/8	3.93	100	1.00	25	1-7/8	2.87	73	

1J926

Female Seal-Lok® - Swivel - 90° Elbow - Short Drop

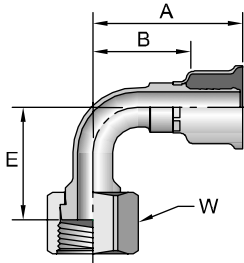

# Part Number	Thread		Hose I.D. inch	A		E		W		B	
	inch	inch		inch	mm	inch	mm	inch	mm	inch	mm
1J926-4-4	1/4	9/16x18	3/16	1.80	46	0.83	21	11/16	0.93	24	
1J926-6-6	3/8	11/16x16	5/16	1.86	47	0.91	23	13/16	1.00	25	
1J926-8-8	1/2	13/16x16	13/32	2.14	54	1.14	29	15/16	1.28	33	
1J926-10-10	5/8	1x14	1/2	2.53	64	1.26	32	1-1/8	1.58	40	
1J926-12-12	3/4	1-3/16x12	5/8	2.51	64	1.89	48	1-3/8	1.57	40	
1J926-16-16	1	1-7/16x12	7/8	3.56	90	2.21	56	1-5/8	2.52	64	
1J926-20-20	1-1/4	1-11/16x12	1-1/8	4.05	103	2.51	64	1-7/8	2.99	76	

1S526

Male Tube-O - Swivel - Short Pilot

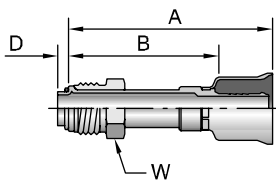

# Part Number	Thread		Hose I.D. inch	A		D		W		B	
	inch	inch		inch	mm	inch	mm	inch	mm	inch	mm
1S526-6-6	3/8	5/8x18	5/16	2.54	65	0.18	4,7	5/8	1.68	43	
1S526-7-6	11/16	11/16x16	5/16	2.57	65	0.18	4,7	5/8	1.71	43	
1S526-8-8	1/2	3/4x18	13/32	2.68	68	0.18	4,7	3/4	1.82	46	
1S526-10-10	5/8	7/8x18	1/2	3.46	88	0.18	4,7	7/8	2.51	64	
1S526-10-12	5/8	7/8x18	5/8	3.63	92	0.18	4,7	7/8	2.69	68	
1S526-12-12	3/4	1-1/16x16	5/8	4.00	102	0.18	4,7	1-1/16	3.06	78	

When measuring overall length to the end of the nut, B+D must be used to calculate cut-off allowance.

See Accessories Section for O-Rings.

1S526-PR

Male Tube-O - Swivel - Short Pilot
with Charge Port for R12

# Part Number	Thread		Hose I.D. inch	A		D		G		W inch	B	
	inch	7/8x18		inch	mm	inch	mm	inch	mm		inch	mm
1S526-10-10-PR	5/8	7/8x18	1/2	3.52	89	0.18	4,7	0.47	12	7/8	2.57	65
1S526-10-12-PR	5/8	7/8x18	5/8	3.68	93	0.18	4,7	0.47	12	7/8	2.74	70

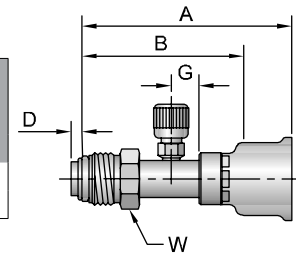

15R26

Male Tube-O - Swivel - 45° Elbow - Short Pilot

# Part Number	Thread		Hose I.D. inch	A		D		E		W inch	B	
	inch	5/8x18		inch	mm	inch	mm	inch	mm		inch	mm
15R26-6-6	3/8	5/8x18	5/16	2.52	64	0.18	4,7	0.85	22	5/8	1.66	42
15R26-8-8	1/2	3/4x18	13/32	2.53	64	0.18	4,7	1.05	27	3/4	1.67	42
15R26-10-10	5/8	7/8x18	1/2	2.99	76	0.18	4,7	1.25	32	7/8	2.04	52
15R26-10-12	5/8	7/8x18	5/8	3.16	80	0.18	4,7	1.25	32	7/8	2.22	56

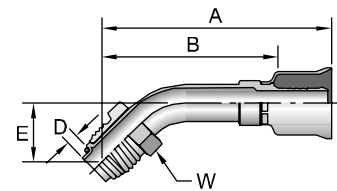

15K26

Male Tube-O - Swivel - 90° Elbow - Short Pilot

# Part Number	Thread		Hose I.D. inch	A		D		E		W inch	B	
	inch	5/8x18		inch	mm	inch	mm	inch	mm		inch	mm
15K26-6-6	3/8	5/8x18	5/16	2.06	52	0.18	4,7	1.76	45	5/8	1.19	30
15K26-7-6	7/16	11/16x16	5/16	2.21	56	0.18	4,7	1.76	44	11/16	1.35	34
15K26-8-8	1/2	3/4x18	13/32	2.06	52	0.18	4,7	1.74	44	3/4	1.20	30
15K26-10-10	5/8	7/8x18	1/2	2.34	59	0.18	4,7	2.20	56	7/8	1.39	35
15K26-10-12	5/8	7/8x18	5/8	2.51	64	0.18	4,7	2.20	56	7/8	1.57	40

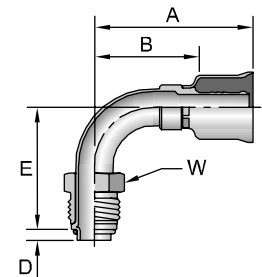

15K26-PB

Male Tube-O - Swivel - 90° Elbow - Short Pilot
with High Pressure Charge Port for R134a

# Part Number	Thread		Hose I.D. inch	A		D		E		G		W inch	B	
	inch	3/4x18		inch	mm	inch	mm	inch	mm	inch	mm		inch	mm
15K26-8-8-PB	1/2	3/4x18	13/32	2.70	69	0.18	4,6	1.74	44	0.60	15	3/4	1.88	48

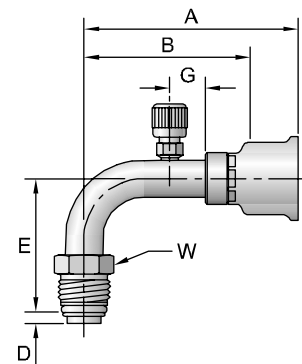

15K26-PR

Male Tube-O - Swivel - 90° Elbow - Short Pilot
with Charge Port for R12

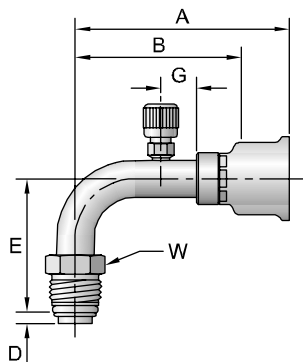

# Part Number	Thread		Hose I.D.	A		D		E		G		W	B	
	inch	mm	inch	inch	mm	inch	mm	inch	mm	inch	mm	inch	inch	mm
15K26-10-10-PR	5/8	7/8x18	1/2	3.14	80	0.18	4,7	2.25	57	0.60	15	7/8	2.19	56
15K26-10-12-PR	5/8	7/8x18	5/8	3.43	87	0.18	4,7	2.22	56	0.60	15	7/8	2.49	63

14526-PR

Male Tube-O - Swivel - Long Pilot With
Charge Port for R12

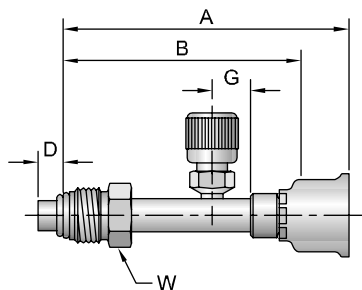

# Part Number	Thread		Hose I.D.	A		D		G		W	B	
	inch	mm	inch	inch	mm	inch	mm	inch	mm	inch	inch	mm
14526-6-6-PR	3/8	5/8x18	5/16	3.25	83	0.28	7,1	0.50	13	5/8	2.40	61

14526-PT

Male Tube-O - Swivel - Long Pilot With
With Low Pressure Charge Port for R134a

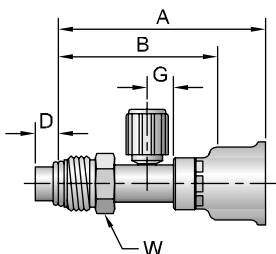

# Part Number	Thread		Hose I.D.	A		D		G		W	B	
	inch	mm	inch	inch	mm	inch	mm	inch	mm	inch	inch	mm
14526-10-12-PT	5/8	7/8x18	5/8	3.45	88	0.38	9,8	0.44	11	7/8	2.51	64

15M26-PR

Male Tube-O - Swivel - 90° Elbow - Long Pilot With
Charge Port for R12

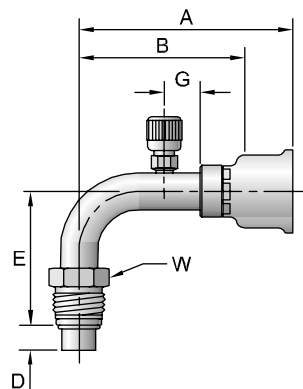

# Part Number	Thread		Hose I.D.	A		D		E		G		W	B	
	inch	mm	inch	inch	mm	inch	mm	inch	mm	inch	mm	inch	inch	mm
15M26-6-6-PR	3/8	5/8x18	5/16	2.48	63	0.28	7,1	1.58	40	0.50	13	5/8	1.62	41

15M26-PT

Male Tube-O - Swivel - 90° Elbow - Long Pilot With
With Low Pressure Charge Port for R134a

# Part Number	Thread		Hose I.D.		A		D		E		G		W		B	
	inch	mm	inch	mm	inch	mm	inch	mm	inch	mm	inch	mm	inch	mm	inch	mm
15M26-10-12-PT	5/8	7/8x18	5/8	3.25	83	0.38	9,8	2.25	57	0.60	15	7/8	2.31	59		

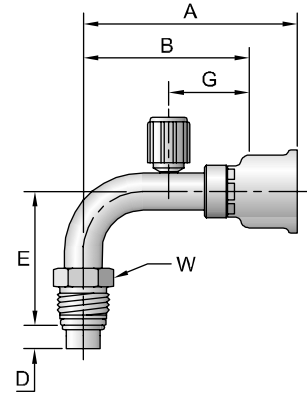

15G26

Male Tube-O - Rigid - Internal Long Pilot (3-Step)

# Part Number	Thread		Hose I.D.		A		H		B	
	inch	mm	inch	mm	inch	mm	inch	mm	inch	mm
15G26-6-6	3/8	5/8x18	3/8	1.78	45	0.625	0.92	23		
15G26-8-8	1/2	3/4x16	13/32	1.95	50	3/4	1.09	28		
15G26-10-10	5/8	7/8x14	1/2	4.05	103	7/8	3.10	79		
15G26-10-12	5/8	7/8x14	5/8	2.19	56	0.875	1.25	32		

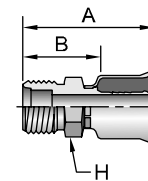

15G26-PR

Male Tube-O - Rigid - Internal Long Pilot (3-Step)
With Charge Port for R12

# Part Number	Thread		Hose I.D.		A		G		W		B	
	inch	mm	inch	mm	inch	mm	inch	mm	inch	mm	inch	mm
15G26-10-12-PR	5/8	7/8x14	5/8	4.27	108	0.60	15	7/8	3.33	85		

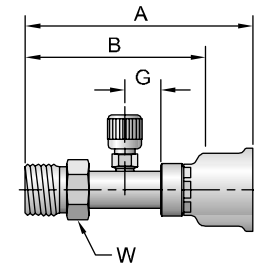

15S26

Female Tube-O - Swivel - Short Pilot

# Part Number	Thread		Hose I.D.		A		D		W		B	
	inch	mm	inch	mm	inch	mm	inch	mm	inch	mm	inch	mm
15S26-6-6	3/8	5/8x18	5/16	2.54	65	0.18	4,7	3/4	1.68	43		
15S26-8-8	1/2	3/4x16	13/32	2.68	68	0.18	4,7	7/8	1.82	46		
15S26-10-10	5/8	7/8x14	1/2	2.84	72	0.18	4,7	1-1/16	1.89	48		
15S26-10-12	5/8	7/8x14	5/8	3.63	92	0.18	4,7	1-1/16	2.69	68		
15S26-12-12	3/4	1-1/16x14	5/8	4.00	102	0.18	4,7	1-1/4	3.06	78		

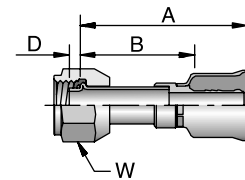

15H26

Female Tube-O - Swivel 45° Elbow - Short Pilot

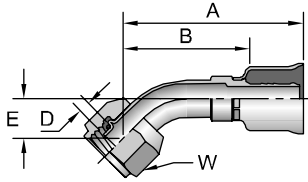

# Part Number	Thread inch	Hose I.D. inch	A		D		E		W		B	
			inch	mm	inch	mm	inch	mm	inch	inch	mm	mm
15H26-6-6	3/8 5/8x18	5/16	2.35	60	0.18	4,7	0.54	14	3/4	1.49	38	
15H26-8-8	1/2 3/4x16	13/32	2.48	63	0.18	4,7	0.60	15	7/8	1.62	41	
15H26-10-10	5/8 7/8x14	1/2	3.23	82	0.18	4,7	0.67	17	1 1/16	2.28	58	
15H26-10-12	5/8 7/8x14	3/4	3.43	87	0.18	4,7	0.67	17	1-1/16	2.46	62	

15T26

Female Tube-O - Swivel - 90° Elbow - Short Pilot

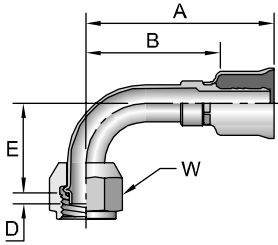

# Part Number	Thread inch	Hose I.D. inch	A		D		E		W		B	
			inch	mm	inch	mm	inch	mm	inch	inch	mm	mm
15T26-6-6	3/8 5/8x18	5/16	1.89	48	0.18	4,7	1.15	29	3/4	1.03	26	
15T26-8-8	1/2 3/4x16	13/32	2.34	59	0.18	4,7	1.46	37	7/8	1.48	38	
15T26-10-10	5/8 7/8x14	1/2	2.08	53	0.18	4,7	1.75	44	1-1/16	1.08	27	
15T26-10-12	5/8 7/8x14	5/8	2.20	56	0.18	4,7	1.53	39	1-1/16	1.26	32	
15T26-12-12	3/4 1-1/16x14	5/8	2.63	67	0.18	4,7	1.75	44	1-1/4	1.69	43	

15926-PB

Female Tube-O - Swivel - Long Pilot
With High Pressure Charge Port for R134a

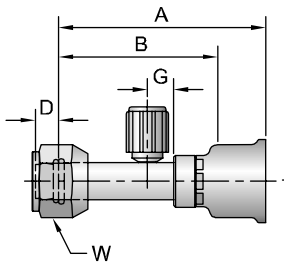

# Part Number	Thread inch	Hose I.D. inch	A		D		G		W		B	
			inch	mm	inch	mm	inch	mm	inch	inch	mm	mm
15926-6-6-PB	3/8 5/8x18	5/16	3.25	83	0.28	7,1	0.75	19	3/4	2.39	61	
15926-8-8-PB	1/2 3/4x16	13/32	2.74	70	0.38	9,8	0.50	13	7/8	1.88	48	

15926-PT

Female Tube-O - Swivel - Long Pilot
With Low Pressure Charge Port for R134a

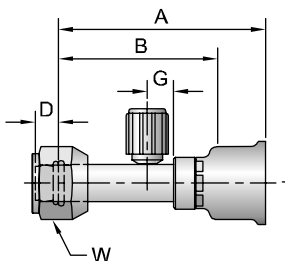

# Part Number	Thread inch	Hose I.D. inch	A		D		G		W		B	
			inch	mm	inch	mm	inch	mm	inch	inch	mm	mm
15926-10-12-PT	5/8 7/8x14	5/8	3.47	88	0.38	9,8	0.60	15	1-1/16	2.53	64	

15N26-PB

Female Tube-O - Swivel - 45° Elbow - Long Pilot
With High Pressure Charge Port for R134a

# Part Number	Thread		Hose I.D.		A		D		E		G		W		B	
	inch		inch		inch	mm	inch	mm	inch	mm	inch	mm	inch	mm	inch	mm
15N26-8-8-PB	1/2	3/4x16	13/32		3.67	93	0.38	9,8	0.90	23	0.60	15	7/8	2.81	72	

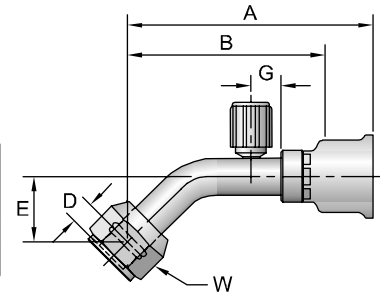

15N26-PT

Female Tube-O - Swivel - 45° Elbow - Long Pilot
With Low Pressure Charge Port for R134a

# Part Number	Thread		Hose I.D.		A		D		E		G		W		B	
	inch		inch		inch	mm	inch	mm	inch	mm	inch	mm	inch	mm	inch	mm
15N26-10-12-PT	5/8	7/8x14	5/8		3.92	100	0.38	9,8	1.21	31	0.60	15	1-1/16	2.98	76	

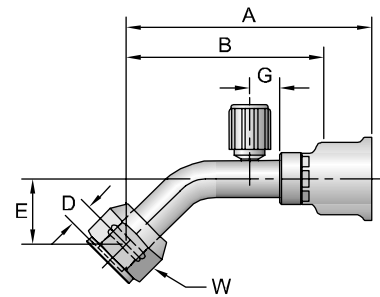

15L26

Female Tube-O - Swivel - 90° Elbow - Long Pilot

# Part Number	Thread		Hose I.D.		A		D		E		W		B	
	inch		inch		inch	mm	inch	mm	inch	mm	inch	mm	inch	mm
15L26-8-8	1/2	3/4x14	13/32		2.14	54	0.38	9,8	1.46	37	7/8	1.28	33	

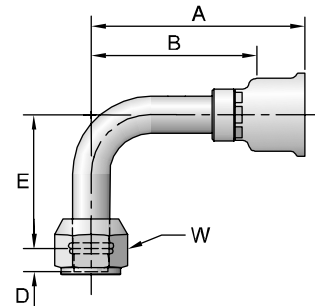

15L26-PB

Female Tube-O - Swivel - 90° Elbow - Long Pilot
With High Pressure Charge Port for R134a

# Part Number	Thread		Hose I.D.		A		D		E		G		W		B	
	inch		inch		inch	mm	inch	mm	inch	mm	inch	mm	inch	mm	inch	mm
15L26-6-6-PB	3/8	5/8x18	5/16		2.50	64	0.28	7,1	1.22	31	0.50	13	3/4	1.64	42	
15L26-8-8-PB	1/2	3/4x16	13/32		2.80	71	0.38	9,8	1.46	37	0.60	15	7/8	1.94	49	
15L26-10-12-PB	5/8	7/8x14	5/8		2.80	71	0.38	9,8	1.46	37	0.60	15	1-1/16	1.94	49	

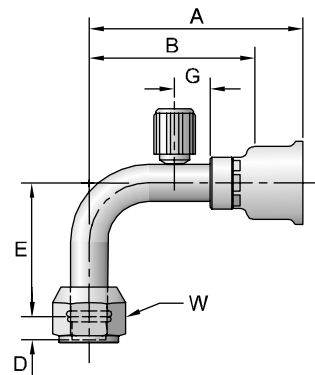

15L26-PR

Female Tube-O - Swivel - 90° Elbow - Long Pilot
With Charge Port for R12

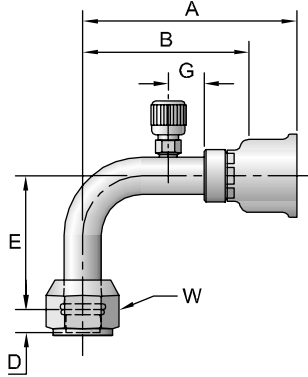

# Part Number	Thread inch		Hose I.D. inch	A inch mm		D inch mm		E inch mm		G inch mm		W inch	B inch mm	
15L26-8-8-PR	1/2	3/4x16	13/32	2.79	71	0.38	9,8	1.46	37	0.60	15	7/8	1.93	49
15L26-10-10-PR	5/8	7/8x14	1/2	3.59	91	0.38	9,8	2.25	57	0.60	15	1-1/16	2.64	67
15L26-10-12-PR	5/8	7/8x14	5/8	3.25	83	0.38	9,8	2.25	57	0.60	15	1-1/16	2.31	59

15L26-PT

Female Tube-O - Swivel - 90° Elbow - Long Pilot
With Low Pressure Charge Port for R134a

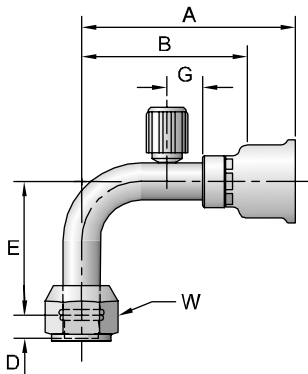

# Part Number	Thread inch		Hose I.D. inch	A inch mm		D inch mm		E inch mm		G inch mm		W inch	B inch mm	
15L26-10-10-PT	5/8	7/8x14	1/2	2.95	75	0.38	9,8	2.25	57	0.60	15	1-1/16	2.00	51
15L26-10-12-PT	5/8	7/8x14	5/8	3.25	83	0.38	9,8	2.25	57	0.60	15	1-1/16	2.31	59
15L26-12-12-PT	3/4	1-1/16x14	5/8	3.58	91	0.38	9,8	2.66	68	0.60	15	1-1/4	2.64	67

15P26-PT

Male Tube-O - Swivel - 45° Elbow - Long Pilot With
With Low Pressure Charge Port for R134a

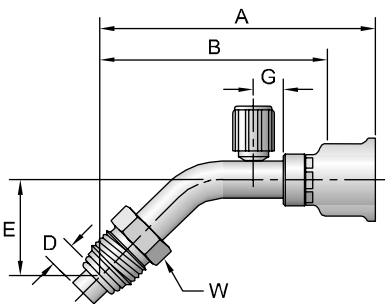

# Part Number	Thread inch		Hose I.D. inch	A inch mm		D inch mm		E inch mm		G inch mm		W inch	B inch mm	
15P26-10-12-PT	5/8	7/8x18	5/8	3.81	97	0.38	9,8	1.21	31	0.60	15	7/8	2.87	73

17B26

Female Air Brake Jounce Line - Swivel

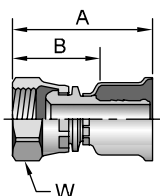

# Part Number	Thread inch		Hose inch	A inch mm		W inch	B inch mm	
17B26-8-6BA	1/2	3/4x20	5/16	1.75	44	11/16	0.89	23
17B26-8-8BA	1/2	3/4x20	13/32	1.75	44	11/16	0.89	23

15V26

Female Compressor - Swivel - 45° Elbow

# Part Number	Thread inch	Hose I.D. inch	A		E		W inch	B	
			inch	mm	inch	mm		inch	mm
15V26-12-8	1x14	13/32	2.72	69	0.75	19	1-1/8	1.86	47
15V26-12-12	1x14	5/8	3.39	86	0.76	19	1-1/8	2.45	62

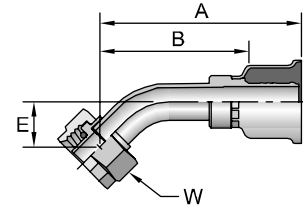

15W26

Female Compressor - Swivel - 90° Elbow

# Part Number	Thread inch	Hose I.D. inch	A		E		W inch	B	
			inch	mm	inch	mm		inch	mm
15W26-12-8	1x14	13/32	2.24	57	1.25	32	1.125	1.38	35
15W26-12-12	1x14	5/8	3.04	77	1.63	41	1.125	2.10	53

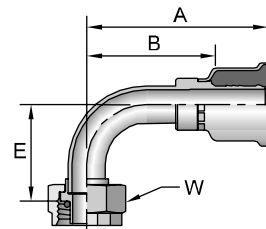

15Z26

Female Compressor - Swivel - 90° Elbow - Block Type

# Part Number	Thread inch	Hose I.D. inch	A		E		W inch	B	
			inch	mm	inch	mm		inch	mm
15Z26-12-8	1X14	0.40625	1.79	45	0.80	20	1.125	0.93	24
15Z26-12-12	1X14	0.625	1.87	47	0.80	20	1.125	0.93	24

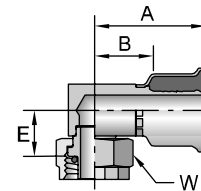

1RV26

Female Compressor - Swivel - 135° Elbow

# Part Number	Hose I.D. inch	inch	A		E		W inch	B	
			inch	mm	inch	mm		inch	mm
1RV26-12-8	13/32	3.24	82	3.21	82	1-1/8	2.38	60	
1RV26-12-12	5/8	2.32	59	3.21	82	1-1/8	1.38	35	

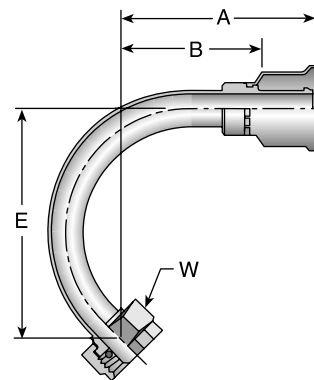

1RZ26

Female Compressor - Swivel - 180° Elbow - Block Type RZ

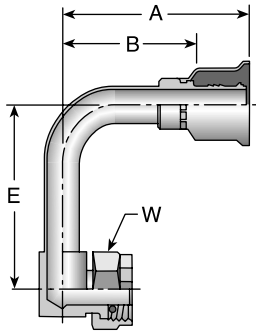

# Part Number	Thread inch	Hose I.D. inch	A		E		W		B	
			inch	mm	inch	mm	inch	inch	mm	
1RZ26-12-12	1x14	5/8	2.98	76	3.13	80	1-1/8	2.04	52	

1T126

Male Refrigerant Tube Mender
(with Nut and Ferrule)

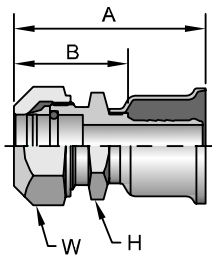

# Part Number	Thread inch		Hose I.D. inch	A		H inch	B	
	inch	mm		inch	mm		inch	mm
1T126-6-6	3/8	5/8x18	5/16	1.96	50	11/16	1.10	28
1T126-8-8	1/2	3/4x16	13/32	2.07	53	13/16	1.21	31
1T126-10-10	5/8	7/8x14	1/2	2.28	58	15/16	1.33	34
1T126-10-12	5/8	7/8x14	5/8	2.27	58	15/16	1.33	34
1T126-12-12	3/4	1-16x14	5/8	2.33	59	1-1/8	1.39	35

1T126 Assembly instructions on page B-25.

1T126

Fitting Installation Instructions

1. Cut the tube off squarely next to the hose fitting. At least 7/8" straight length is required and the outside diameter of the tube should be smooth and free from deep lengthwise scratches.
2. To prevent cutting the inside of the O-Ring, smoothly chamfer the outside diameter of the cut end 15° to 30°. Deburr the inside diameter.
3. Remove the nut, compression sleeve, and O-Ring from the fitting and lubricate the O-Ring with a lubricant that is compatible with the refrigerant used in the system.
4. Place the lubricated O-Ring in the counterbore of the fitting.
5. Slip the compression sleeve, small end, into the nut and assemble the nut on the fitting fingertight. Make sure the compression sleeve is not cocked in the nut. Back the nut off 1/6 to 1/3 turn (one to two hex flats).
6. Insert the chamfered tube end through the nut into the fitting. If high resistance is felt when the end of the tube contacts the O-Ring, remove the tube. The end of the tube may require a large chamfer and/or the O-Ring may require more lubrication on the inside diameter. Repeat the previous steps.
7. (a) Make sure the tube is bottomed in the fitting
(b) Tighten the nut finger tight
(c) Mark the fitting and nut hex indicating the starting point (see illustration) and
(d) Wrench tighten the nut 1 to 1-1/6 turns (6 to 7 hex flats).
8. Later, if it is ever necessary to loosen the connection, re-assemble the nut 1/6 turn (one hex flat) after finger tight.

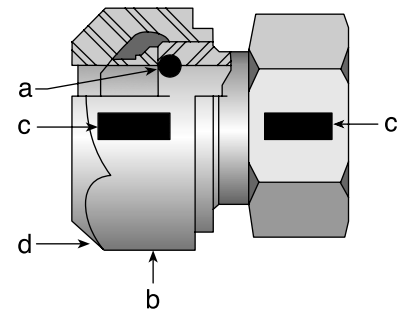

IF YOU HAVE QUESTIONS CONCERNING THE PRODUCTS
OR APPLICATION OF THE PRODUCTS CONTAINED IN THIS

CATALOG, PLEASE CALL:

PARKER HOSE PRODUCTS DIVISION
TECHNICAL SERVICES DEPARTMENT

PHONE: 440 / 943-5700

FAX: 440 / 943-3129

<http://www.parkerhose.com>











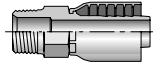
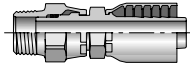
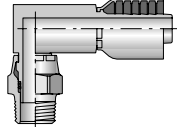
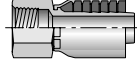
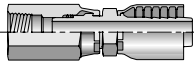
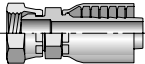

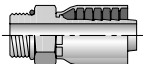
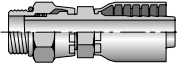
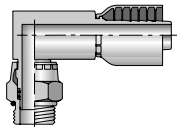

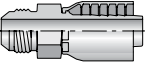
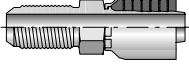
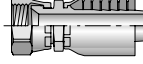
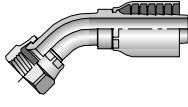
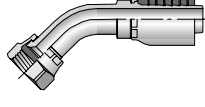
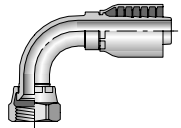
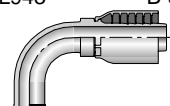
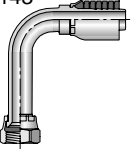
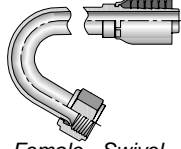

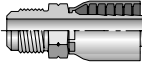
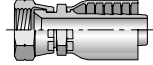
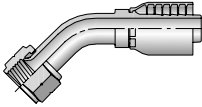
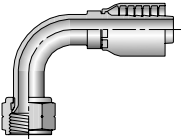
A

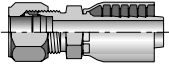
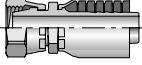
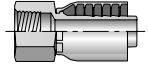
B

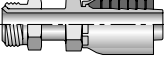
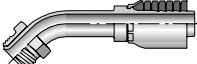
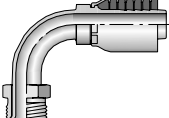
C

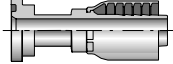
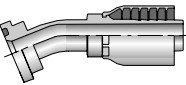
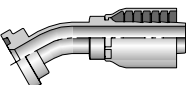
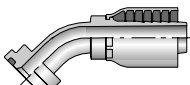
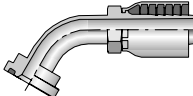
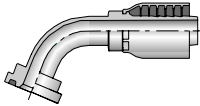
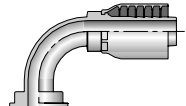
D

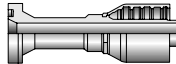
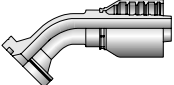
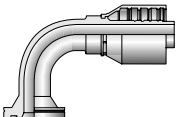
E

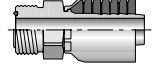
	10143 B-29  Male - Rigid	11343 B-29  Male - Swivel	11L43 B-30  Male - Swivel 90° Elbow	10243 B-30  Female - Rigid	1S243 B-30  Female - Swivel
10743 B-31  Female - Swivel		10543 B-31  Male - Rigid	10G43 B-31  Male - Swivel	10L43 B-32  Male - Swivel 90° Elbow	
10343 B-32  Male - Rigid	1LB43 B-33  Male - Bulkhead	10643 B-33  Female - Swivel	13743 B-34  Female - Swivel 45° Elbow - Short	1L743 B-34  Female - Swivel 45° Elbow - Medium	13943 B-35  Female - Swivel 90° Elbow - Short
1L943 B-35  Female - Swivel 90° Elbow - Medium	14143 B-36  Female - Swivel 90° Elbow - Long	14V43 B-36  Female - Swivel 150° Elbow		10443 B-36  Male - Rigid	10843 B-36  Female - Swivel
17743 B-37  Female - Swivel 45° Elbow	17943 B-37  Female - Swivel 90° Elbow		11143 B-37  Male - Rigid	11243 B-38  Female - Swivel	1GJ43 B-38  Female - Rigid
	12843 B-38  Male - Swivel	16743 B-39  Male - Swivel 45° Elbow	16943 B-39  Male - Swivel 90° Elbow		11543 B-39  Flange Head
11643 B-40  22-1/2° Elbow	12643 B-40  30° Elbow	11743 B-40  45° Elbow	12743 B-41  60° Elbow	11843 B-41  67-1/2° Elbow	11943 B-41  90° Elbow
	16A43 B-42  Flange Head	16F43 B-42  45° Elbow	16N43 B-42  90° Elbow		1J043 B-43  Male - Rigid w/O-Ring











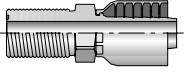
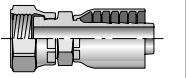
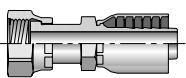
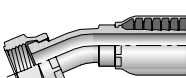
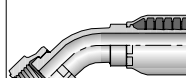
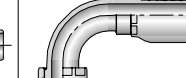
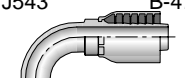
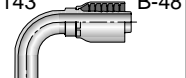

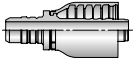
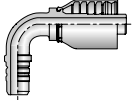
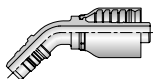
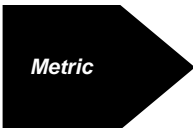
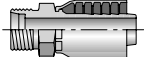
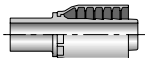
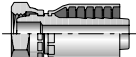
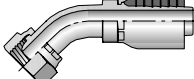
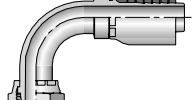
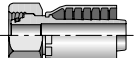
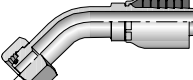
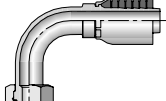

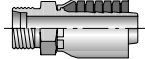
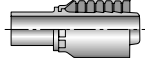
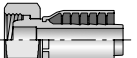
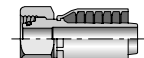
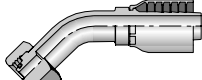
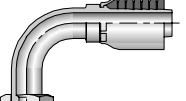
A

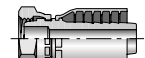
B

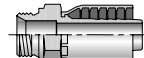
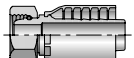
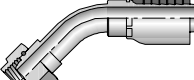
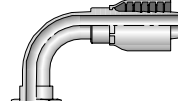
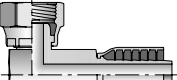
C

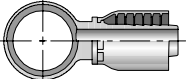
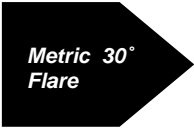
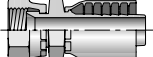
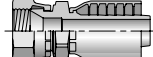
D

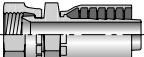
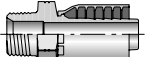
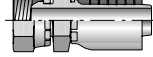
E

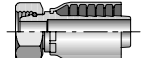
1JB43 B-43  Male - Bulkhead w/O-Ring	1JC43 B-44  Female - Swivel Short	1JS43 B-45  Female - Swivel Long	1J643 B-45  Female - Swivel 22-1/2° Elbow	1J743 B-46  Female - Swivel 45° Elbow	1J943 B-47  Female - Swivel 90° Elbow - Short
1J543 B-47  Female - Swivel 90° Elbow - Medium	1J143 B-48  Female - Swivel 90° Elbow - Long	 UPTC	1EN43 B-50  Male	1ET43 B-50  Male 90° Elbow	1EU43 B-50  Male 45° Elbow
 Metric	1D043 B-51  Male - Rigid	11D43 B-51  Male Standpipe Rigid	1C343 B-52  Female - Swivel	1C443 B-52  Female - Swivel 45° Elbow	1C543 B-52  Female - Swivel 90° Elbow
1CA43 B-53  Female - Swivel	1CE43 B-53  Female - Swivel 45° Elbow	1CF43 B-53  Female - Swivel 90° Elbow	 DIN "S" Series & DIN "S" w/O-Ring	1D243 B-54  Male - Rigid	13D43 B-54  Male Standpipe Rigid
1C643 B-54  Female - Swivel	1C943 B-55  Female - Swivel	10C43 B-55  Female - Swivel 45° Elbow	11C43 B-56  Female - Swivel 90° Elbow	 DIN 60° Cone	1C043 B-55  Female - Swivel
 BSP	1D943 B-56  Male - Rigid	19243 B-56  Female - Swivel	1B143 B-57  Female - Swivel 45° Elbow	1B243 B-57  Female - Swivel 90° Elbow	1B443 B-57  Female - Swivel 90° Elbow - Block Type
1B543 B-58  Female - Swivel Flat Seat	 Banjo	14943 B-58  Metric Banjo	 Metric 30° Flare	1MU43 B-59  Female - Swivel	1XU43 B-59  Female - Swivel
 BSP	1FU43 B-59  Female - Swivel	1UT43 B-60  Male - Rigid	1GU43 B-60  Female - Swivel	 French Gaz	1F443 B-60  Female - Swivel

A

B

C

D

E

10143 Male NPTF Pipe - Rigid

# Part Number	Thread inch	Hose I.D. inch	A		H inch	B		Additional Material Stainless Steel (C)
			inch	mm		inch	mm	
10143-2-4	1/8x27	1/4	1.80	46	9/16	1.05	27	
10143-4-4	1/4x18	1/4	2.01	51	9/16	1.26	32	•
10143-4-5	1/4x18	5/16	1.94	49	11/16	1.19	30	
10143-4-6	1/4x18	3/8	2.28	58	3/4	1.25	32	
10143-6-4	3/8x18	1/4	1.86	47	11/16	1.11	28	
10143-6-5	3/8x18	5/16	1.94	49	11/16	1.19	30	
10143-6-6	3/8x18	3/8	2.37	60	3/4	1.34	34	•
10143-6-8	3/8x18	1/2	2.59	66	7/8	1.33	34	
10143-6-10	3/8x18	5/8	2.61	66	15/16	1.17	30	
10143-8-4	1/2x14	1/4	2.13	54	7/8	1.38	35	
10143-8-6	1/2x14	3/8	2.39	61	7/8	1.36	35	
10143-8-8	1/2x14	1/2	2.84	72	7/8	1.58	40	•
10143-8-10	1/2x14	5/8	3.04	77	15/16	1.59	40	
10143-8-12	1/2x14	3/4	3.04	77	1-1/16	1.60	41	
10143-12-8	3/4x14	1/2	2.68	68	1-1/16	1.42	36	
10143-12-10	3/4x14	5/8	2.87	73	1-1/16	1.43	36	
10143-12-12	3/4x14	3/4	3.09	78	1-1/16	1.65	42	•
10143-12-16	3/4x14	1	3.40	86	1-3/8	1.78	45	
10143-16-12	1x11-1/2	3/4	3.09	78	1-3/8	1.65	42	
10143-16-16	1x11-1/2	1	2.59	66	1-3/8	1.97	50	•
10143-20-20	1-1/4x11-1/2	1-1/4	4.08	104	1-3/4	2.39	61	•
10143-24-24	1-1/2x11-1/2	1-1/2	3.50	89	2	2.13	54	
10143-32-32	2x11-1/2	2	4.05	103	2-1/2	2.27	58	

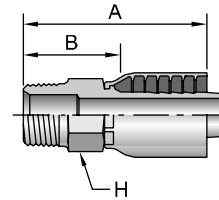

Stainless steel fittings must be assembled with Karrykrimp 2, PHastkrimp, Superkrimp or Parkrimp 2. See CrimpSource for more information.

11343 Male NPTF Pipe - Swivel

# Part Number	Thread inch	Hose I.D. inch	A		W inch	B	
			inch	mm		inch	mm
11343-2-4	1/8x27	1/4	2.94	75	5/8	2.19	56
11343-4-4	1/4x18	1/4	2.68	68	5/8	1.93	49
11343-4-6	1/4x18	3/8	3.01	76	5/8	1.98	50
11343-6-4	3/8x18	1/4	2.81	71	3/4	2.06	52
11343-6-6	3/8x18	3/8	3.08	78	3/4	2.05	52
11343-6-8	3/8x18	1/2	3.30	84	3/4	2.04	52
11343-8-6	1/2x14	3/8	3.30	84	7/8	2.27	58
11343-8-8	1/2x14	1/2	3.52	89	7/8	2.26	57
11343-12-12	3/4x14	3/4	3.93	100	1-1/4	2.49	63
11343-16-16	1x11-1/2	1	4.52	115	1-1/2	2.90	74

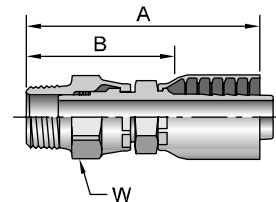

O-Ring not compatible with Phosphate Ester fluids.

Fitting allows minor movement under pressure to relieve stress on hose but is not to be used on continuous or extensive swiveling.

11L43

Male NPTF Pipe - Swivel - 90° Elbow

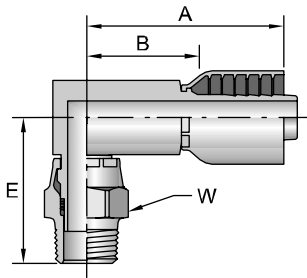

# Part Number	Thread inch	Hose I.D. inch	A		E		W inch	B	
			inch	mm	inch	mm		inch	mm
11L43-4-4	1/4x18	1/4	2.23	57	1.79	45	5/8	1.48	38
11L43-4-6	1/4x18	3/8	2.53	64	1.85	47	5/8	1.50	38
11L43-6-6	3/8x18	3/8	2.53	64	1.94	49	3/4	1.50	38
11L43-8-6	1/2x14	3/8	2.66	68	2.17	55	7/8	1.63	41
11L43-8-8	1/2x14	1/2	2.96	75	2.17	55	7/8	1.70	43
11L43-12-12	3/4x14	3/4	3.32	84	2.46	62	1-1/4	1.88	48

O-Ring not compatible with Phosphate Ester fluids.

Fitting allows minor movement under pressure to relieve stress on hose but is not to be used on continuous or extensive swiveling.

10243

Female NPTF Pipe - Rigid

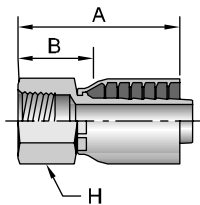

# Part Number	Thread inch	Hose I.D. inch	A		H inch	B	
			inch	mm		inch	mm
10243-2-4	1/8x27	1/4	1.68	43	5/8	0.93	24
10243-4-4	1/4x18	1/4	1.78	45	11/16	1.03	26
10243-4-6	1/4x18	3/8	2.05	52	3/4	1.02	26
10243-6-4	3/8x18	1/4	2.05	52	7/8	1.30	33
10243-6-6	3/8x18	3/8	2.32	59	7/8	1.29	33
10243-8-6	1/2x14	3/8	2.40	61	1-1/8	1.37	35
10243-8-8	1/2x14	1/2	2.62	67	1-1/8	1.36	35
10243-12-12	3/4x14	3/4	2.72	69	1-1/4	1.28	33

1S243

Female NPTF Pipe - Swivel

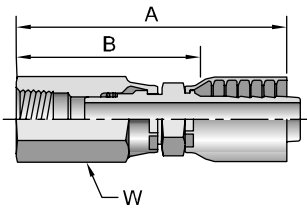

# Part Number	Thread inch	Hose I.D. inch	A		W inch	B	
			inch	mm		inch	mm
1S243-4-4	1/4x18	1/4	3.33	85	3/4	2.58	66

10743

Female NPSM Pipe - Swivel - (60° Cone)

# Part Number	Thread		Hose I.D. inch	A		H inch	W inch	B	
	inch	mm		inch	mm			inch	mm
10743-2-4	1/8x27		1/4	1.69	43	9/16	9/16	0.94	24
10743-4-4	1/4x18		1/4	1.74	44	9/16	11/16	0.99	25
10743-6-6	3/8x18		3/8	2.09	53	11/16	7/8	1.06	27
10743-8-8	1/2x14		1/2	2.32	59	15/16	1	1.06	27
10743-12-12	3/4x14		3/4	2.70	69	1-1/16	1-1/4	1.47	37
10743-16-16	1x11-1/2		1	3.09	78	1-3/8	1-1/2	1.47	37
10743-20-20	1-1/4x11-1/2		1-1/4	3.28	83	1-7/8	1-7/8	1.59	40

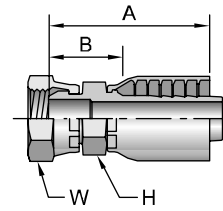

10543

Male SAE Straight Thread with O-Ring - Rigid

# Part Number	Thread		Hose I.D. inch	A		H inch	B	
	inch	mm		inch	mm		inch	mm
10543-4-4	1/4	7/16x20	1/4	1.64	42	9/16	0.89	23
10543-5-4	5/16	1/2x20	1/4	1.80	46	5/8	1.05	27
10543-6-4	3/8	9/16x18	1/4	1.67	42	11/16	0.92	23
10543-6-6	3/8	9/16x18	3/8	2.10	53	11/16	1.07	27
10543-6-8	3/8	9/16x18	1/2	2.32	59	13/16	1.06	27
10543-8-6	1/2	3/4x16	3/8	2.11	54	7/8	1.08	27
10543-8-8	1/2	3/4x16	1/2	2.46	62	7/8	1.20	30
10543-10-6	5/8	7/8x14	3/8	2.13	54	1	1.10	28
10543-10-8	5/8	7/8x14	1/2	2.35	60	1	1.09	28
10543-10-10	5/8	7/8x14	5/8	2.77	70	1	1.33	34
10543-12-8	3/4	1-1/16x12	1/2	2.61	66	1-1/4	1.35	34
10543-12-10	3/4	1-1/16x12	5/8	2.80	71	1-1/4	1.36	35
10543-12-12	3/4	1-1/16x12	3/4	2.81	71	1-1/4	1.37	35
10543-16-12	1	1-5/16x12	3/4	2.81	71	1-1/2	1.37	35
10543-16-16	1	1-5/16x12	1	3.37	86	1-1/2	1.75	44
10543-20-20	1-1/4	1-5/8x12	1-1/4	3.69	94	1-7/8	2.00	51

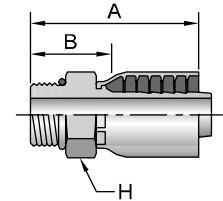

10G43

Male SAE Straight Thread with O-Ring - Swivel

# Part Number	Thread		Hose I.D. inch	A		W inch	B	
	inch	mm		inch	mm		inch	mm
10G43-5-4	5/16	1/2x20	1/4	2.98	76	3/4	2.23	57
10G43-6-4	3/8	9/16x18	1/4	2.98	76	3/4	2.23	57
10G43-6-6	3/8	9/16x18	3/8	3.25	83	3/4	2.22	56
10G43-8-6	1/2	3/4x16	3/8	3.06	78	7/8	2.06	52
10G43-8-8	1/2	3/4x16	1/2	3.21	82	7/8	1.95	50
10G43-10-6	5/8	7/8x14	3/8	3.01	76	1	2.01	51
10G43-10-8	5/8	7/8x14	1/2	3.27	83	1	2.01	51
10G43-12-12	3/4	1-1/16x12	3/4	3.78	96	1-1/4	2.34	59

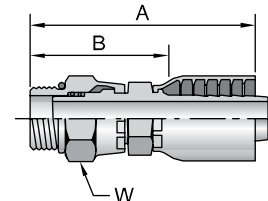

O-Ring not compatible with Phosphate Ester fluids.

Fitting allows minor movement under pressure to relieve stress on hose but is not to be used on continuous or extensive swiveling.

10L43

Male SAE Straight Thread with O-Ring - Swivel - 90° Elbow

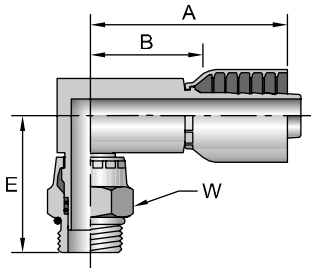

# Part Number	Thread		Hose I.D. inch	A		E		W inch	B	
	inch	mm		inch	mm	inch	mm		inch	mm
10L43-6-6	3/8	9/16x18	3/8	2.53	64	2.10	53	3/4	1.50	38
10L43-8-6	1/2	3/4x16	3/8	2.66	68	1.86	47	7/8	1.63	41
10L43-8-8	1/2	3/4x16	1/2	2.96	75	1.87	47	7/8	1.70	43
10L43-10-8	5/8	7/8x14	1/2	2.96	75	1.92	49	1	1.70	43
10L43-12-12	3/4	1-1/16x12	3/4	3.22	82	2.30	58	1-1/4	1.88	48

O-Ring not compatible with Phosphate Ester fluids.

See Technical Section for pressure limitations.

Fitting allows minor movement under pressure to relieve stress on hose but is not to be used on continuous or extensive swiveling.

10343

Male JIC 37° - Rigid

ISO 12151-5

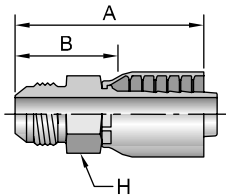

# Part Number	Thread		Hose I.D. inch	A		H inch	B	
	inch	mm		inch	mm		inch	mm
10343-4-4	1/4	7/16x20	1/4	1.99	51	9/16	1.24	31
10343-5-4	5/16	1/2x20	1/4	1.83	46	9/16	1.08	27
10343-5-6	5/16	1/2x20	3/8	2.26	57	3/4	1.23	31
10343-6-4	3/8	9/16x18	1/4	1.84	47	11/16	1.09	28
10343-6-6	3/8	9/16x18	3/8	2.36	60	3/4	1.33	34
10343-8-6	1/2	3/4x16	3/8	2.30	58	7/8	1.27	32
10343-8-8	1/2	3/4x16	1/2	2.68	68	7/8	1.42	36
10343-8-10	1/2	3/4x16	5/8	2.85	72	7/8	1.41	36
10343-10-6	5/8	7/8x14	3/8	2.40	61	15/16	1.37	35
10343-10-8	5/8	7/8x14	1/2	2.62	67	15/16	1.36	35
10343-10-10	5/8	7/8x14	5/8	3.03	77	15/16	1.59	40
10343-12-8	3/4	1-1/16x12	1/2	2.76	70	1-1/8	1.50	38
10343-12-10	3/4	1-1/16x12	5/8	3.07	78	1-1/8	1.63	41
10343-12-12	3/4	1-1/16x12	3/4	3.19	81	1-1/8	1.75	44
10343-14-12	7/8	1-3/16x12	3/4	3.11	79	1-1/4	1.67	42
10343-16-12	1	1-5/16x12	3/4	3.04	77	1-3/8	1.60	41
10343-16-16	1	1-5/16x12	1	3.63	92	1-3/8	2.01	51
10343-20-20	1-1/4	1-5/8x12	1-1/4	3.96	101	1-7/8	2.27	58
10343-24-20	1-1/2	1-7/8x12	1-1/4	3.71	94	2	2.02	51

1LB43

Male JIC 37° - Bulkhead without Locknut

ISO 12151-5

# Part Number	Thread		Hose I.D. inch	A		H inch	B	
	inch	7/16x20		inch	mm		inch	mm
1LB43-4-4	1/4	7/16x20	1/4	2.64	67	9/16	1.89	48
1LB43-6-6	3/8	9/16x18	3/8	3.08	78	3/4	2.05	52
1LB43-8-8	1/2	3/4x16	1/2	3.46	88	7/8	2.20	56
1LB43-10-10	5/8	7/8x14	5/8	3.85	98	15/16	2.41	61
1LB43-12-12	3/4	1-1/16x12	3/4	4.08	104	1-1/8	2.64	67

Fittings are stocked less locknut (part no. WLN). Locknuts are manufactured by the Parker Tube Fittings Division and must be ordered separately.

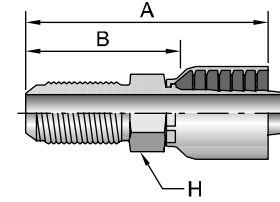

10643

Female JIC 37° - Swivel

ISO 12151-5

# Part Number	Thread		Hose I.D. inch	A		H inch	W inch	B		Additional Material Stainless Steel (C)
	inch	7/16x20		inch	mm			inch	mm	
10643-4-4	1/4	7/16x20	1/4	1.94	49	9/16	9/16	1.19	30	•
10643-4-6	1/4	7/16x20	3/8	2.20	56	11/16	9/16	1.17	30	
10643-5-4	5/16	1/2x20	1/4	2.03	52	9/16	5/8	1.28	33	
10643-5-5	5/16	1/2x20	5/16	2.08	53	11/16	5/8	1.33	34	
10643-5-6	5/16	1/2x20	3/8	2.26	57	11/16	5/8	1.23	31	
10643-6-4	3/8	9/16x18	1/4	2.05	52	9/16	11/16	1.30	33	
10643-6-5	3/8	9/16x18	5/16	2.10	53	11/16	11/16	1.35	34	
10643-6-6	3/8	9/16x18	3/8	2.29	58	11/16	11/16	1.26	32	•
10643-6-8	3/8	9/16x18	1/2	2.51	64	13/16	11/16	1.25	32	
10643-8-6	1/2	3/4x16	3/8	2.49	63	11/16	7/8	1.46	37	•
10643-8-8	1/2	3/4x16	1/2	2.77	67	13/16	7/8	1.51	35	•
10643-8-10	1/2	3/4x16	5/8	2.82	72	15/16	7/8	1.38	35	
10643-8-12	1/2	3/4x16	3/4	2.83	72	1-1/16	7/8	1.39	35	
10643-10-6	5/8	7/8x14	3/8	2.51	64	7/8	1	1.48	38	
10643-10-8	5/8	7/8x14	1/2	2.85	72	7/8	1	1.59	40	
10643-10-10	5/8	7/8x14	5/8	2.93	74	15/16	1	1.49	38	•
10643-10-12	5/8	7/8x14	3/4	2.93	74	1-1/16	1	1.49	38	
10643-12-8	3/4	1-1/16x12	1/2	2.78	71	1-1/16	1-1/4	1.52	39	
10643-12-10	3/4	1-1/16x12	5/8	3.10	79	1-1/16	1-1/4	1.66	42	
10643-12-12	3/4	1-1/16x12	3/4	3.17	81	1-1/16	1-1/4	1.73	44	•
10643-12-16	3/4	1-1/16x12	1	3.29	84	1-3/8	1-1/4	1.67	42	
10643-14-12	7/8	1-3/16x12	3/4	3.18	81	1-1/4	1-3/8	1.74	44	
10643-16-12	1	1-5/16x12	3/4	3.31	84	1-1/4	1-1/2	1.87	47	
10643-16-16	1	1-5/16x12	1	3.62	92	1-3/8	1-1/2	2.00	51	•
10643-20-16	1-1/4	1-5/8x12	1	3.81	97	1-5/8	2	2.19	56	
10643-20-20	1-1/4	1-5/8x12	1-1/4	3.94	100	1-7/8	2	2.25	57	•
10643-24-24	1-1/2	1-7/8x12	1-1/2	3.84	98	2-1/8	2-1/4	2.47	63	
10643-32-32	2	2-1/2x12	2	4.73	120	2-1/2	2-7/8	2.95	75	

Stainless steel fittings must be assembled with Karrykrimp 2, PHastkrimp, Superkrimp or Parkrimp 2. See CrimpSource for more information.

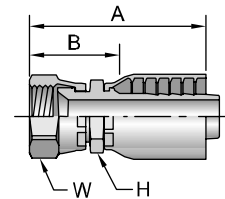

13743

Female JIC 37° - Swivel - 45° Elbow - Short Drop

ISO 12151-5

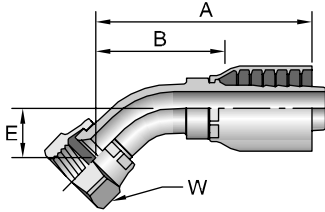

# Part Number	Thread		Hose I.D. inch	A		E		W inch	B	
	inch	mm		inch	mm	inch	mm		inch	mm
13743-4-4	1/4	7/16x20	1/4	1.96	50	0.39	10	9/16	1.21	31
13743-5-4	5/16	1/2x20	1/4	2.19	56	0.39	10	5/8	1.44	37
13743-6-4	3/8	9/16x18	1/4	2.23	57	0.39	10	11/16	1.48	38
13743-6-6	3/8	9/16x18	3/8	2.39	61	0.39	10	11/16	1.39	35
13743-8-6	1/2	3/4x16	3/8	2.74	70	0.55	14	7/8	1.74	44
13743-8-8	1/2	3/4x16	1/2	2.83	72	0.55	14	7/8	1.57	40
13743-10-8	5/8	7/8x14	1/2	2.93	74	0.63	16	1	1.67	42
13743-10-10	5/8	7/8x14	5/8	3.17	81	0.63	16	1	1.73	44
13743-12-10	3/4	1-1/16x12	5/8	3.62	92	0.83	21	1-1/4	2.08	53
13743-12-12	3/4	1-1/16x12	3/4	3.63	92	0.78	20	1-1/4	2.19	56
13743-16-16	1	1-5/16x12	1	4.34	110	0.95	24	1-1/2	2.72	69
13743-20-20	1-1/4	1-5/8x12	1-1/4	4.59	117	1.19	30	2	2.82	72
13743-24-24	1-1/2	1-7/8x12	1-1/2	5.50	140	1.47	37	2-1/4	4.18	106

1L743

Female JIC 37° - Swivel - 45° Elbow - Medium Drop

ISO 12151-5

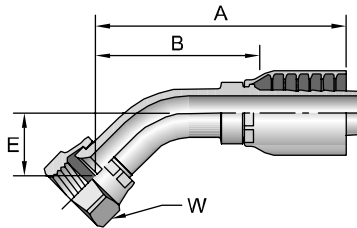

# Part Number	Thread		Hose I.D. inch	A		E		W inch	B	
	inch	mm		inch	mm	inch	mm		inch	mm
1L743-6-6	3/8	9/16x18	3/8	2.66	62	0.59	15	11/16	1.63	41
1L743-8-8	1/2	3/4x16	1/2	3.17	80	0.72	18	7/8	1.91	49
1L743-12-12	3/4	1-1/16x12	3/4	4.23	107	1.06	27	1-1/4	2.79	71
1L743-16-16	1	1-5/16x12	1	4.51	115	1.07	27	1-1/2	2.89	73

13943

Female JIC 37° - Swivel - 90° Elbow - Short Drop
ISO 12151-5

# Part Number	Thread		Hose I.D. inch	A		E		W inch	B	
	inch	mm		inch	mm	inch	mm		inch	mm
13943-4-4	1/4	7/16x20	1/4	1.78	45	0.83	21	9/16	1.03	26
13943-4-6	1/4	7/16x20	3/8	2.11	54	0.83	21	9/16	1.08	27
13943-5-4	5/16	1/2x20	1/4	1.88	48	0.83	21	5/8	1.13	29
13943-5-5	5/16	1/2x20	5/16	1.96	50	0.83	21	5/8	1.21	31
13943-6-4	3/8	9/16x18	1/4	2.12	54	0.85	22	11/16	1.37	35
13943-6-6	3/8	9/16x18	3/8	2.21	56	0.91	23	11/16	1.18	30
13943-6-8	3/8	9/16x18	1/2	2.51	64	0.85	22	11/16	1.25	32
13943-8-6	1/2	3/4x16	3/8	2.52	64	1.09	28	7/8	1.49	38
13943-8-8	1/2	3/4x16	1/2	2.62	67	1.14	29	7/8	1.36	35
13943-10-8	5/8	7/8x14	1/2	2.74	70	1.26	32	1	1.48	38
13943-10-10	5/8	7/8x14	5/8	2.97	75	1.26	32	1	1.69	39
13943-12-8	3/4	1-1/16x12	1/2	3.25	83	1.83	46	1-1/4	1.99	51
13943-12-10	3/4	1-1/16x12	5/8	3.07	78	1.89	48	1-1/4	1.63	41
13943-12-12	3/4	1-1/16x12	3/4	3.49	89	1.89	48	1-1/4	2.05	52
13943-16-12	1	1-5/16x12	3/4	3.49	89	2.00	51	1-1/2	2.05	52
13943-16-16	1	1-5/16x12	1	4.28	109	2.20	56	1-1/2	2.66	68
13943-20-20	1-1/4	1-5/8x12	1-1/4	4.43	113	2.59	66	2	2.74	70
13943-24-24	1-1/2	1-7/8x12	1-1/2	5.50	140	3.81	81	2-1/4	4.13	105
13943-32-32	2	2-1/2x12	2	6.75	171,4	4.62	117	2-7/8	4.97	126,2

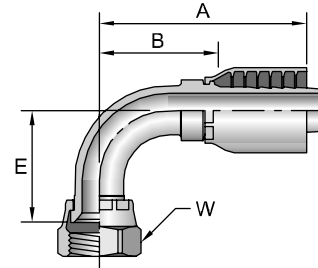

A

B

C

1L943

Female JIC 37° - Swivel - 90° Elbow - Medium Drop
ISO 12151-5

# Part Number	Thread		Hose I.D. inch	A		E		W inch	B	
	inch	mm		inch	mm	inch	mm		inch	mm
1L943-4-4	1/4	7/16x20	1/4	1.84	47	1.26	32	9/16	1.09	28
1L943-6-4	3/8	9/16x18	1/4	2.12	54	1.50	38	11/16	1.37	35
1L943-6-6	3/8	9/16x18	3/8	2.29	58	1.50	38	11/16	1.26	32
1L943-8-6	1/2	3/4x16	3/8	2.51	64	1.61	41	7/8	1.48	38
1L943-8-8	1/2	3/4x16	1/2	2.64	67	1.61	41	7/8	1.38	35
1L943-10-8	5/8	7/8x14	1/2	3.25	83	1.75	44	1	1.99	51
1L943-12-12	3/4	1-1/16x12	3/4	3.49	89	2.28	58	1-1/4	2.05	52
1L943-16-16	1	1-5/16x12	1	4.44	113	2.50	64	1-1/2	2.82	72

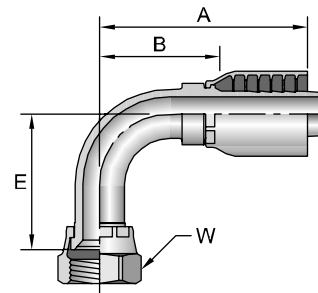

D

E

A

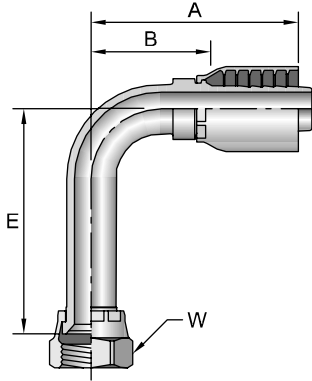

14143

Female JIC 37° - Swivel - 90° Elbow - Long Drop

ISO 12151-5

# Part Number	Thread		Hose I.D. inch	A		E		W		B	
	inch			inch	mm	inch	mm	inch	inch	mm	mm
14143-4-4	1/4	7/16x20	1/4	1.96	50	1.81	46	9/16	1.21	31	
14143-5-4	5/16	1/2x20	1/4	1.93	49	1.80	46	5/8	1.18	30	
14143-6-6	3/8	9/16x18	3/8	2.27	58	2.18	55	11/16	1.27	32	
14143-8-6	1/2	3/4x16	3/8	2.56	65	2.43	62	7/8	1.56	40	
14143-8-8	1/2	3/4x16	1/2	2.62	67	2.52	64	7/8	1.36	35	
14143-10-8	5/8	7/8x14	1/2	2.78	71	2.58	66	1	1.52	39	
14143-10-10	5/8	7/8x14	5/8	3.16	80	2.58	66	1	1.75	44	
14143-12-12	3/4	1-1/16x12	3/4	3.49	89	3.74	95	1-1/4	2.05	52	
14143-14-12	7/8	1-3/16x12	3/4	3.38	86	3.93	100	1-3/8	1.95	50	
14143-16-16	1	1-5/16x12	1	3.90	99	4.32	110	1-1/2	2.31	59	
14143-20-20	1-1/4	1-5/8x12	1-1/4	4.39	112	5.28	134	2	2.73	69	

B

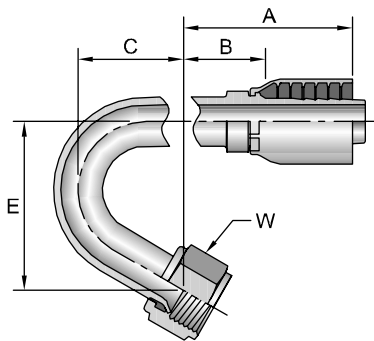

14V43

Female JIC 37° - Swivel - 150° Elbow

ISO 12151-5

# Part Number	Thread		Hose I.D. inch	A		C		E		W		B	
	inch			inch	mm	inch	mm	inch	mm	inch	inch	mm	mm
14V43-6-4	3/8	9/16x18	1/4	2.89	73	1.36	11/16	1.97	50	11/16	2.16	55	

C

D

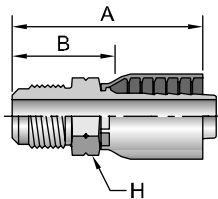

10443

Male SAE 45° - Rigid

# Part Number	Thread		Hose I.D. inch	A		H		B	
	inch			inch	mm	inch	inch	inch	mm
10443-6-6	3/8	5/8x18	3/8	2.21	56	3/4	1.21	31	
10443-12-12	3/4	1-1/16x14	3/4	3.20	81	1-1/8	1.77	45	

E

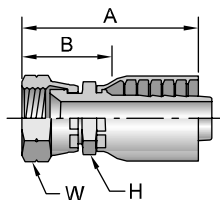

10843

Female SAE 45° - Swivel

# Part Number	Thread		Hose I.D. inch	A		H		W		B	
	inch			inch	mm	inch	inch	inch	mm	mm	
10843-6-4	3/8	5/8x18	1/4	2.11	54	3/4	3/4	1.36	35		
10843-6-6	3/8	5/8x18	3/8	2.38	60	3/4	3/4	1.35	34		
10843-12-12	3/4	1-1/16x14	3/4	3.17	81	1-1/16	1-1/4	1.73	44		

Notch on nut signifies SAE 45° flare.

17743

Female SAE 45° - Swivel - 45° Elbow

# Part Number	Thread		Hose I.D. inch	A		E		W inch	B	
	inch	7/16x20		inch	mm	inch	mm		inch	mm
17743-4-6	1/4	7/16x20	3/8	2.28	58	0.33	8	9/16	1.25	32

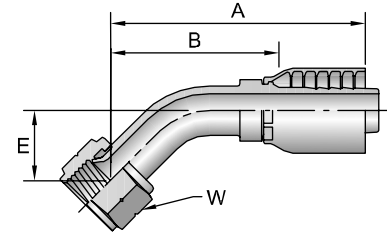

17943

Female SAE 45° - Swivel - 90° Elbow

# Part Number	Thread		Hose I.D. inch	A		E		W inch	B	
	inch	5/8x18		inch	mm	inch	mm		inch	mm
17943-6-6	3/8	5/8x18	3/8	2.13	54	0.85	22	3/4	1.13	29

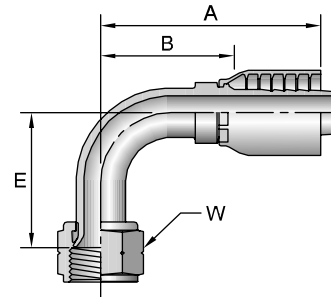

11143

Male Ferulok Flareless - Rigid
(24° Cone with Nut and Ferrule)

# Part Number	Thread		Hose I.D. inch	A		H inch	W inch	B	
	inch	7/16x20		inch	mm			inch	mm
11143-4-4	1/4	7/16x20	1/4	2.13	54	9/16	9/16	1.40	36
11143-4-6	1/4	7/16x20	3/8	2.44	62	3/4	9/16	1.44	37
11143-5-4	5/16	1/2x20	1/4	2.13	54	9/16	5/8	1.40	36
11143-5-6	5/16	1/2x20	3/8	2.44	62	3/4	5/8	1.44	37
11143-6-6	3/8	9/16x18	3/8	2.50	64	3/4	11/16	1.50	38
11143-8-8	1/2	3/4x16	1/2	2.93	74	7/8	7/8	1.68	43
11143-10-8	5/8	7/8x14	1/2	3.07	78	15/16	1	1.82	46
11143-12-12	3/4	1-1/16x12	3/4	3.39	86	1-1/8	1-1/4	1.96	50
11143-16-16	1	1-5/16x12	1	3.80	97	1-3/8	1-1/2	2.18	55

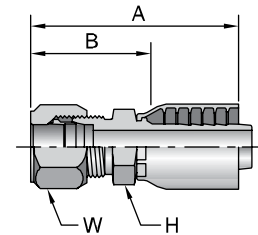

The Parker Ferrul-Fix fitting makes it possible to salvage the bent tube section from a hose assembly for quick, easy on-the-job repairs. For additional information see Ferrule-Fix installation instructions in the Technical Section.

Notch on nut signifies SAE 45° flare.

11243

Female Ferulok Flareless - Swivel - (24° Cone)

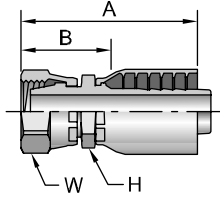

# Part Number	Thread		Hose I.D. inch	A		H inch	W inch	B	
	inch			inch	mm			inch	mm
11243-6-6	3/8	9/16x18	3/8	2.51	64	11/16	11/16	1.48	38
11243-8-6	1/2	3/4x16	3/8	2.67	68	7/8	7/8	1.64	42
11243-8-8	1/2	3/4x16	1/2	2.89	73	7/8	7/8	1.63	41

1GJ43

Female Grease Connection - SPL - PTF Taper Thread Rigid - 1/2 x 27

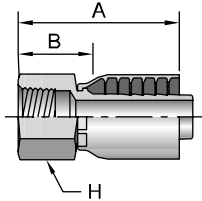

# Part Number	Thread inch	Hose I.D. inch	A		H inch	B	
			inch	mm		inch	mm
1GJ43-4-4	1/2x27	1/4	1.79	45	3/4	1.04	26
1GJ43-4-6	1/2x27	3/8	2.05	52	3/4	1.02	26

12843

Male Inverted SAE 45° - Swivel

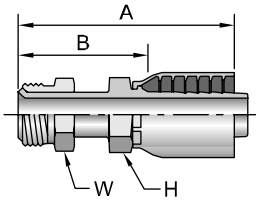

# Part Number	Thread		Hose I.D. inch	A		H inch	W inch	B	
	inch			inch	mm			inch	mm
12843-4-4	1/4	7/16x24	1/4	2.32	59	9/16	7/16	1.57	40
12843-4-6	1/4	7/16x24	3/8	2.65	67	11/16	7/16	1.62	41
12843-5-4	5/16	1/2x20	1/4	2.60	66	9/16	1/2	1.85	47
12843-5-6	5/16	1/2x20	3/8	2.74	70	11/16	1/2	1.71	43
12843-6-6	3/8	5/8x18	3/8	2.86	73	11/16	5/8	1.83	46
12843-7-6	7/16	11/16x18	3/8	2.95	75	11/16	11/16	1.92	49
12843-8-8	1/2	3/4x18	1/2	3.11	79	13/16	3/4	1.85	47
12843-10-10	5/8	7/8x18	5/8	3.55	90	3/4	7/8	2.11	54

16743

Male Inverted SAE 45° - Swivel - 45° Elbow

# Part Number	Thread		Hose I.D. inch	A		E		W inch	B	
	inch	mm		inch	mm	inch	mm		inch	mm
16743-4-4	1/4	7/16x24	1/4	2.09	53	0.63	16	7/16	1.34	34
16743-4-6	1/4	7/16x24	3/8	2.42	61	0.63	16	7/16	1.39	35
16743-5-4	5/16	1/2x20	1/4	2.34	59	0.70	18	1/2	1.59	40
16743-5-6	5/16	1/2x20	3/8	2.48	63	0.70	18	1/2	1.45	37
16743-6-6	3/8	5/8x18	3/8	2.93	74	0.94	24	5/8	1.90	48
16743-8-8	1/2	3/4x18	1/2	3.23	82	1.09	28	3/4	1.97	50

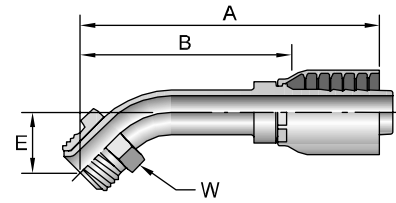

16943

Male Inverted SAE 45° - Swivel - 90° Elbow

# Part Number	Thread		Hose I.D. inch	A		E		W inch	B	
	inch	mm		inch	mm	inch	mm		inch	mm
16943-4-4	1/4	7/16x24	1/4	2.16	55	1.56	40	7/16	1.41	36
16943-4-6	1/4	7/16x24	3/8	2.49	63	1.56	40	7/16	1.46	37
16943-5-4	5/16	1/2x20	1/4	2.41	61	1.65	42	1/2	1.66	42
16943-5-6	5/16	1/2x20	3/8	2.59	66	1.65	42	1/2	1.56	40
16943-6-6	3/8	5/8x18	3/8	2.61	66	1.69	43	5/8	1.58	40
16943-7-6	7/16	11/16x18	3/8	2.53	64	1.72	44	11/16	1.50	38
16943-8-8	1/2	3/4x18	1/2	2.81	71	1.88	48	3/4	1.55	39

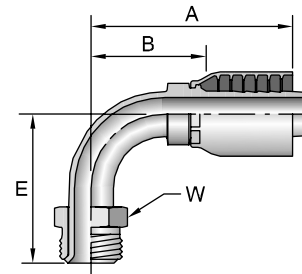

11543

SAE Code 61 Flange Head ISO 12151-3 - S - L

# Part Number	Flange inch	Hose I.D. inch	A		F inch	B	
			inch	mm		inch	mm
11543-8-8	1/2	1/2	3.48	88	1-3/16	2.22	56
11543-10-10	5/8	5/8	3.78	96,0	1-11/32	2.34	59,4
11543-12-8	3/4	1/2	2.46	62,5	1-1/2	1.20	30,5
11543-12-12	3/4	3/4	3.54	90	1-1/2	2.10	53
11543-16-12	1	3/4	2.74	70	1-3/4	1.30	33
11543-16-16	1	1	4.25	108	1-3/4	2.63	67
11543-20-16	1-1/4	1	3.19	81	2	1.57	40
11543-20-20	1-1/4	1-1/4	4.70	119	2	3.01	76
11543-24-20	1-1/2	1-1/4	3.22	82	2-3/8	1.53	39
11543-24-24	1-1/2	1-1/2	4.59	117	2-3/8	3.22	82
11543-24-32	1-1/2	2	5.65	144	2-7/8	3.87	98
11543-32-20	2	1-1/4	4.29	109,0	2-13/16	2.60	66,0
11543-32-24	2	1-1/2	3.14	80	2-7/8	1.77	45
11543-32-32	2	2	4.99	127	2-13/16	3.21	82

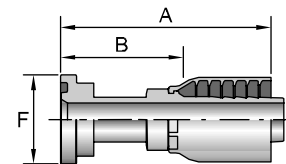

See Accessories Section for O-Rings and Flange Kits.

11643

SAE Code 61 Flange Head - 22-1/2° Elbow

ISO 12151-3 - E22M - L

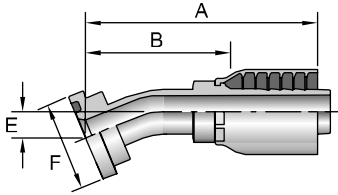

# Part Number	Flange inch	Hose I.D. inch	A		E		F inch	B	
			inch	mm	inch	mm		inch	mm
11643-12-12	3/4	3/4	3.90	99	0.44	11	1-1/2	2.47	63
11643-16-12	1	3/4	3.89	99	0.44	11	1-3/4	2.46	62
11643-16-16	1	1	4.25	108	0.44	11	1-3/4	2.66	68
11643-20-16	1-1/4	1	4.25	108	0.44	11	2	2.66	68
11643-20-20	1-1/4	1-1/4	4.65	118	0.50	13	2	3.00	76
11643-24-20	1-1/2	1-1/4	4.66	118	0.51	13	2-3/8	3.01	76

12643

SAE Code 61 Flange Head - 30° Elbow

ISO 12151-3 - E30S - L (1 Piece: ISO 12151-3 - E30M - L)

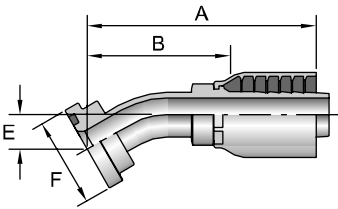

# Part Number	Flange inch	Hose I.D. inch	A		E		F inch	B	
			inch	mm	inch	mm		inch	mm
12643-12-12	3/4	3/4	3.90	99	0.59	15	1-1/2	2.46	62
12643-16-16	1	1	4.38	111	0.62	16	1-3/4	2.76	70
12643-20-16	1-1/4	1	4.38	111	0.62	16	2	2.76	70
12643-20-20	1-1/4	1-1/4	4.39	112	0.72	18	2	2.70	69

11743

SAE Code 61 Flange Head - 45° Elbow

ISO 12151-3 - E45S - L (1 Piece: ISO 12151-3 - E45M - L)

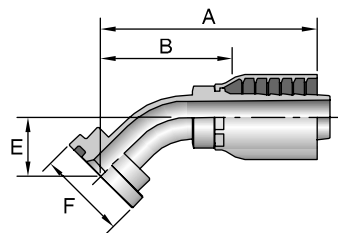

# Part Number	Flange inch	Hose I.D. inch	A		E		F inch	B	
			inch	mm	inch	mm		inch	mm
11743-8-8	1/2	1/2	3.28	83	0.77	20	1-3/16	2.02	51
11743-10-10	5/8	5/8	4.63	118	0.94	24	1-11/32	3.19	81
11743-12-8	3/4	1/2	3.32	84	0.81	21	1-1/2	2.06	52
11743-12-12	3/4	3/4	3.85	98	1.02	26	1-1/2	2.41	61
11743-16-12	1	3/4	3.85	98	1.02	26	1-3/4	2.41	61
11743-16-16	1	1	4.76	121	1.26	32	1-3/4	3.14	80
11743-20-16	1-1/4	1	4.76	121	1.26	32	2	3.14	80
11743-20-20	1-1/4	1-1/4	5.61	142	1.50	38	2	3.92	100
11743-24-24	1-1/4	1-1/2	5.45	138	1.38	35	2	4.08	104
11743-24-20	1-1/2	1-1/4	5.55	141	1.496	38	2-3/8	3.86	98
11743-24-24	1-1/2	1-1/2	5.50	140	1.43	36	2-3/8	4.13	105
11743-32-24	2	1-1/2	5.49	139	1.42	36	2-13/16	4.12	105
11743-32-32	2	2	7.23	184	1.98	50	2-13/16	5.45	138

See Accessories Section for O-Rings and Flange Kits.

12743

SAE Code 61 Flange Head - 60° Elbow

ISO 12151-3 - E60S - L (1 Piece: ISO 12151-3 - E60M - L)

# Part Number	Flange inch	Hose I.D. inch	A		E		F inch	B	
			inch	mm	inch	mm		inch	mm
12743-12-12	3/4	3/4	4.16	105	1.43	36	1-1/2	2.72	69
12743-16-12	1	3/4	4.15	105	1.39	35	1-3/4	2.71	69
12743-16-16	1	1	4.45	113	1.50	38	1-3/4	2.83	72
12743-20-20	1-1/4	1-1/4	5.09	129	1.69	43	2	3.40	86

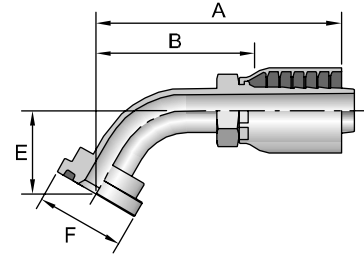

11843

SAE Code 61 Flange Head - 67-1/2° Elbow

ISO 12151-3 - E67S - L (1 Piece: ISO 12151-3 - E67M - L)

# Part Number	Flange inch	Hose I.D. inch	A		E		F inch	B	
			inch	mm	inch	mm		inch	mm
11843-12-12	3/4	3/4	4.09	104	1.60	41	1-1/2	2.66	68
11843-16-16	1	1	4.66	118	1.75	44	1-3/4	3.07	78
11843-20-20	1-1/4	1-1/4	5.04	128	1.94	49	2	3.37	86

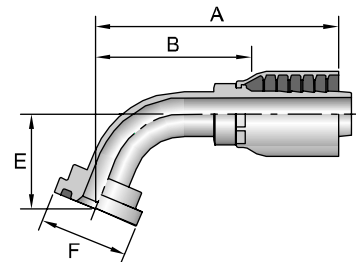

11943

SAE Code 61 Flange Head - 90° Elbow

ISO 12151-3 - E90S - L (1 Piece: ISO 12151-3 - E90M - L)

# Part Number	Flange inch	Hose I.D. inch	A		E		F inch	B	
			inch	mm	inch	mm		inch	mm
11943-8-8	1/2	1/2	2.93	74	1.60	41	1-3/16	1.67	42
11943-10-10	5/8	5/8	3.71	94	2.10	53	1-11/32	2.27	58
11943-12-8	3/4	1/2	2.93	74	1.66	42	1-1/2	1.67	42
11943-12-10	3/4	5/8	3.71	94	2.10	53	1-1/2	2.27	58
11943-12-12	3/4	3/4	3.51	89	2.28	58	1-1/2	2.07	53
11943-16-8	1	1/2	2.91	74	2.03	52	1-3/4	1.65	42
11943-16-12	1	3/4	3.59	91	2.24	57	1-3/4	2.15	55
11943-16-16	1	1	4.28	109	2.78	71	1-3/4	2.66	68
11943-20-16	1-1/4	1	4.25	108	2.76	70	2	2.63	67
11943-20-20	1-1/4	1-1/4	5.12	130	3.54	90	2	3.43	87
11943-24-20	1-1/2	1-1/4	5.09	129	3.54	90	2-3/8	3.40	86
11943-20-24	1-1/4	1-1/2	4.19	106	2.49	63	2	2.82	72
11943-24-24	1-1/2	1-1/2	5.50	140	3.11	79	2-3/8	4.13	105
11943-32-24	2	1-1/2	5.48	139	3.10	79	2-13/16	4.11	104
11943-32-32	2	2	6.75	171	4.48	114	2-13/16	4.97	126

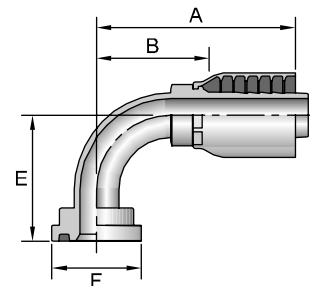

See Accessories Section for O-Rings and Flange Kits.

16A43

SAE Code 62 Flange Head

ISO 12151-3 - S - S

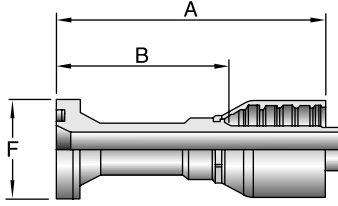

# Part Number	Flange inch	Hose I.D. inch	A		B		F
			inch	mm	inch	mm	inch
16A43-12-12	3/4	3/4	4.12	104,6	2.68	68,0	1-5/8
16A43-16-12	1	3/4	3.10	78,7	1.66	42,2	1-7/8
16A43-16-16	1	1	4.81	122,2	3.19	81,0	1-7/8
16A43-20-16	1-1/4	1	3.61	91,7	1.99	50,5	2-1/8
16A43-20-20	1-1/4	1-1/4	5.01	127,3	3.32	84,3	2-1/8

16F43

SAE Code 62 Flange Head

ISO 12151-3 - E45S - S (1 Piece 12151-3-E45M-S)

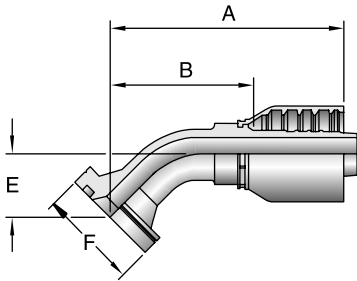

# Part Number	Flange inch	Hose I.D. inch	A		B		F	E	
			inch	mm	inch	mm	inch	inch	mm
16F43-12-12	3/4	3/4	3.82	97,0	2.38	60,5	1-5/8	1.02	25,9
16F43-16-16	1	1	4.66	118,4	3.04	77,2	1-7/8	1.26	32,0
16F43-20-16	1-1/4	1	4.57	116,1	2.95	74,9	2-1/8	1.06	26,9

16N43

SAE Code 62 Flange Head

ISO 12151-3 - E90S - S (1 Piece 12151-3-E90M-S)

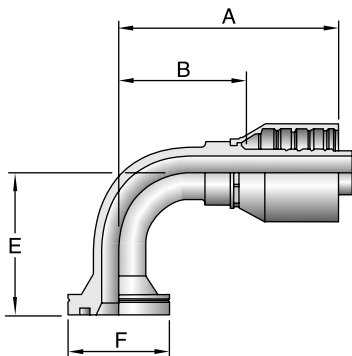

# Part Number	Flange inch	Hose I.D. inch	A		B		F	E	
			inch	mm	inch	mm	inch	inch	mm
16N43-12-12	3/4	3/4	3.51	89,2	2.07	52,6	1-5/8	2.28	57,9
16N43-16-12	1	3/4	3.49	88,6	2.05	52,1	1-7/8	2.28	57,9
16N43-16-16	1	1	4.28	108,7	2.66	67,6	1-7/8	2.76	70,1
16N43-20-16	1-1/4	1	4.28	108,7	2.66	67,6	2-1/8	2.76	70,1
16N43-20-20	1-1/4	1-1/4	5.09	129,3	3.40	86,4	2-1/8	3.54	90,0

1J043

Male Seal-Lok® - Rigid - (with O-Ring)

ISO 12151-1 - S

# Part Number	Thread		Hose I.D. inch	A		H inch	B	
	inch			inch	mm		inch	mm
1J043-4-4	1/4	9/16x18	1/4	1.73	44	5/8	0.98	25
1J043-6-6	3/8	11/16x16	3/8	2.08	53	3/4	1.05	27
1J043-8-6	1/2	13/16x16	3/8	2.20	56	7/8	1.17	30
1J043-8-8	1/2	13/16x16	1/2	2.42	61	7/8	1.17	30
1J043-10-8	5/8	1x14	1/2	2.61	66	1-1/16	1.35	34
1J043-10-10	5/8	1x14	5/8	2.73	69	1-1/16	1.34	34
1J043-12-10	3/4	1-3/16x12	5/8	2.89	73	1-1/4	1.45	37
1J043-12-12	3/4	1-3/16x12	3/4	2.90	74	1-1/4	1.46	37
1J043-16-12	1	1-7/16x12	3/4	2.93	74	1-1/2	1.49	38
1J043-16-16	1	1-7/16x12	1	3.29	84	1-1/2	1.67	42
1J043-20-20	1-1/4	1-11/16x12	1-1/4	3.32	84	1-3/4	1.63	41

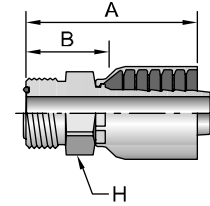

1JB43

Male Seal-Lok® - Bulkhead without Locknut - (with O-Ring)

End Connection per ISO 8434-3-BH

# Part Number	Thread		Hose I.D. inch	A		H inch	B	
	inch			inch	mm		inch	mm
1JB43-4-4	1/4	9/16x18	1/4	2.58	66	5/8	1.83	46
1JB43-6-6	3/8	11/16x16	3/8	2.98	76	3/4	1.95	50
1JB43-8-6	1/2	13/16x16	3/8	3.41	87	7/8	2.38	60
1JB43-8-8	1/2	13/16x16	1/2	3.36	85	7/8	2.10	53
1JB43-10-8	5/8	1x14	1/2	3.58	91	1-1/16	2.32	59
1JB43-10-10	5/8	1x14	5/8	3.77	96	1-1/16	2.33	59
1JB43-12-12	3/4	1-3/16x12	3/4	3.87	98	1-1/4	2.43	62

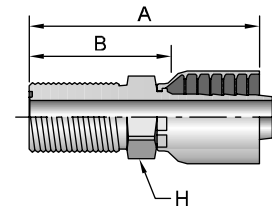

Fittings are stocked less locknut (part no. WLNL). Locknuts are manufactured by the Parker Tube Fittings Division and must be ordered separately.

See Accessories Section for O-Rings and Flange Kits.

1JC43

Female Seal-Lok® - Swivel - Short ISO 12151-1 - SWSA

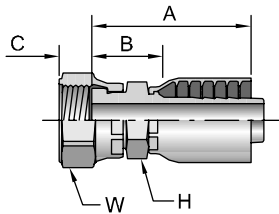

# Part Number	Thread		Hose I.D. inch	A		C		H inch	W inch	B		Additional Material Stainless Steel (C)
	inch	mm		inch	mm	inch	mm					
1JC43-4-4	1/4	9/16x18	1/4	1.63	41	0.32	8	9/16	11/16	0.88	22	•
1JC43-4-4-SM	1/4	9/16x18	1/4	1.63	41	0.32	8	17 mm	17 mm	0.88	22	
1JC43-4-6	1/4	9/16x18	3/8	1.90	48	0.32	8	11/16	11/16	0.87	22	
1JC43-6-4	3/8	11/16x16	1/4	1.67	42	0.32	8	11/16	13/16	0.92	23	
1JC43-6-4-SM	3/8	11/16x16	1/4	1.67	42	0.32	8	17 mm	22 mm	0.92	23	
1JC43-6-5	3/8	11/16x16	5/16	1.65	42	0.32	8	11/16	13/16	0.90	23	
1JC43-6-6	3/8	11/16x16	3/8	1.94	49	0.32	8	11/16	13/16	0.91	23	•
1JC43-6-6-SM	3/8	11/16x16	3/8	1.94	49	0.32	8	19 mm	22 mm	0.91	23	
1JC43-8-6	1/2	13/16x16	3/8	2.00	51	0.43	11	13/16	15/16	0.97	25	
1JC43-8-6-SM	1/2	13/16x16	3/8	2.00	51	0.43	11	19 mm	24 mm	0.97	25	
1JC43-8-8	1/2	13/16x16	1/2	2.22	56	0.43	11	13/16	15/16	0.96	24	•
1JC43-8-8-SM	1/2	13/16x16	1/2	2.22	56	0.43	11	22 mm	24 mm	0.96	24	
1JC43-10-8	5/8	1x14	1/2	2.30	58	0.53	13	15/16	1-1/8	1.04	26	
1JC43-10-8-SM	5/8	1x14	1/2	2.30	58	0.53	13	24 mm	30 mm	1.04	26	
1JC43-10-10	5/8	1x14	5/8	2.49	63	0.53	13	15/16	1-1/8	1.05	27	•
1JC43-10-10-SM	5/8	1x14	5/8	2.49	63	0.53	13	24 mm	30 mm	1.05	27	
1JC43-12-8	3/4	1-3/16x12	1/2	2.48	63	0.57	14	1-1/8	1-3/8	1.22	31	
1JC43-12-10	3/4	1-3/16x12	5/8	2.67	68	0.57	14	1-1/8	1-3/8	1.23	31	
1JC43-12-10-SM	3/4	1-3/16x12	5/8	2.67	68	0.57	14	32 mm	36 mm	1.23	31	
1JC43-12-12	3/4	1-3/16x12	3/4	2.68	68	0.57	14	1-1/8	1-3/8	1.24	31	•
1JC43-12-12-SM	3/4	1-3/16x12	3/4	2.68	68	0.57	14	32 mm	36 mm	1.24	31	
1JC43-12-16	3/4	1-3/16x12	1	2.99	76	0.57	14	1-5/16	1-3/8	1.37	35	
1JC43-16-12	1	1-7/16x12	3/4	2.83	72	0.58	15	1-3/8	1-5/8	1.39	35	
1JC43-16-16	1	1-7/16x12	1	3.14	80	0.58	15	1-3/8	1-5/8	1.52	39	•
1JC43-20-20	1-1/4	1-11/16x12	1-1/4	3.27	83	0.59	15	1-7/8	1-7/8	1.58	40	•

When measuring overall length to the end of the nut, B+C dimensions must be used to calculate cut-off allowance.
Stainless steel fittings must be assembled with Karrykrimp 2, PHastkrimp, Superkrimp or Parkrimp 2.
See CrimpSource for more information.

See Accessories Section for O-Rings.

1JS43

Female Seal-Lok® - Swivel - Long
ISO 12151-1 SWSB

# Part Number	Thread		Hose I.D. inch	A		H inch	W inch	B	
	inch	inch		inch	mm			inch	mm
1JS43-4-4	1/4	9/16x18	1/4	2.07	53	9/16	11/16	1.32	34
1JS43-4-6	1/4	9/16x18	3/8	2.21	56	11/16	11/16	1.18	30
1JS43-6-4	3/8	11/16x16	1/4	2.14	54	9/16	13/16	1.39	35
1JS43-6-6	3/8	11/16x16	3/8	2.28	58	11/16	13/16	1.25	32
1JS43-6-8	3/8	11/16x16	1/2	2.50	64	13/16	13/16	1.24	31
1JS43-8-4	1/2	13/16x16	1/4	2.26	57	11/16	15/16	1.51	38
1JS43-8-6	1/2	13/16x16	3/8	2.53	64	11/16	15/16	1.50	38
1JS43-8-8	1/2	13/16x16	1/2	2.65	67	13/16	15/16	1.39	35
1JS43-8-10	1/2	13/16x16	5/8	2.82	72	15/16	15/16	1.38	35
1JS43-10-6	5/8	1x14	3/8	2.63	67	11/16	1-1/8	1.62	41
1JS43-10-8	5/8	1x14	1/2	2.89	73	13/16	1-1/8	1.63	41
1JS43-10-10	5/8	1x14	5/8	3.07	78	15/16	1-1/8	1.66	42
1JS43-10-12	5/8	1x14	3/4	3.08	78	1-1/16	1-1/8	1.64	42
1JS43-12-8	3/4	1-3/16x12	1/2	2.90	74	15/16	1-3/8	1.64	42
1JS43-12-10	3/4	1-3/16x12	5/8	3.19	81	1-1/8	1-3/8	1.75	44
1JS43-12-12	3/4	1-3/16x12	3/4	3.31	84	1-1/8	1-3/8	1.87	47
1JS43-12-16	3/4	1-3/16x12	1	3.53	90	1-5/16	1-3/8	1.91	49
1JS43-16-12	1	1-7/16x12	3/4	3.37	86	1-3/8	1-5/8	1.93	49
1JS43-16-16	1	1-7/16x12	1	3.62	92	1-3/8	1-5/8	2.00	51
1JS43-16-20	1	1-7/16x12	1-1/4	3.77	96	1-3/4	1-5/8	2.08	53
1JS43-20-16	1-1/4	1-11/16x12	1	3.64	92	1-3/8	1-7/8	2.02	51
1JS43-20-20	1-1/4	1-11/16x12	1-1/4	3.77	96	1-3/4	1-7/8	2.15	53
1JS43-24-20	1-1/2	2x12	1-1/4	3.88	99	1-3/4	2-1/4	2.23	57
1JS43-24-24	1-1/2	2x12	1-1/2	3.91	99	1-7/8	2-1/4	2.54	65

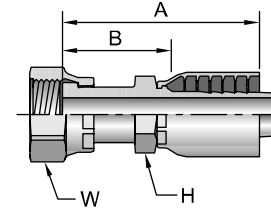

1J643

Female Seal-Lok® - Swivel - 22-1/2° Elbow
End Connection per ISO 8434-3-SWE

# Part Number	Thread		Hose I.D. inch	A		E		W inch	B	
	inch	inch		inch	mm	inch	mm		inch	mm
1J643-8-8	1/2	13/16x16	1/2	3.06	78	0.39	10	15/16	1.80	46

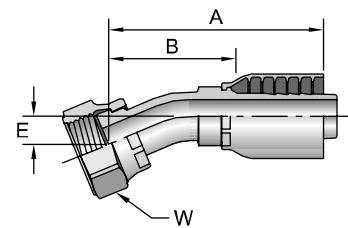

See Accessories Section for O-Rings.

1J743

Female Seal-Lok® - Swivel - 45° Elbow ISO 12151-1 - SWE45

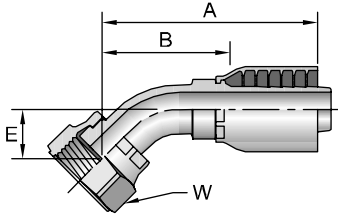

# Part Number	Thread		Hose I.D. inch	A		E		W inch	B	
	inch	inch		inch	mm	inch	mm		inch	mm
1J743-4-4	1/4	9/16x18	1/4	1.97	50	0.39	10	11/16	1.22	31
1J743-4-4-SM	1/4	9/16x18	1/4	1.97	50	0.39	10	17 mm	1.22	31
1J743-4-6	1/4	9/16x18	3/8	2.23	57	0.39	10	11/16	1.20	30
1J743-6-4	3/8	11/16x16	1/4	2.08	53	0.43	11	13/16	1.33	34
1J743-6-4-SM	3/8	11/16x16	1/4	2.08	53	0.43	11	22 mm	1.33	34
1J743-6-5	3/8	11/16x16	5/16	2.37	60	0.43	11	13/16	1.62	41
1J743-6-6	3/8	11/16x16	3/8	2.34	59	0.43	11	13/16	1.31	33
1J743-6-8	3/8	11/16x16	1/2	2.66	68	0.43	11	13/16	1.41	36
1J743-8-4	1/2	13/16x16	1/4	2.56	65	0.59	15	15/16	1.81	46
1J743-8-6	1/2	13/16x16	3/8	2.53	64	0.59	15	15/16	1.50	38
1J743-8-6-SM	1/2	13/16x16	3/8	2.53	64	0.59	15	24 mm	1.50	38
1J743-8-8	1/2	13/16x16	1/2	2.83	72	0.59	15	15/16	1.57	40
1J743-8-8-SM	1/2	13/16x16	1/2	2.83	72	0.59	15	24 mm	1.57	40
1J743-8-10	1/2	13/16x16	5/8	3.09	78	0.59	15	15/16	1.65	42
1J743-10-8	5/8	1x14	1/2	2.93	74	0.63	16	1-1/8	1.67	42
1J743-10-10	5/8	1x14	5/8	3.17	81	0.63	16	1-1/8	1.73	44
1J743-10-10-SM	5/8	1x14	5/8	3.17	81	0.63	16	30 mm	1.73	44
1J743-10-12	5/8	1x14	3/4	3.36	85	0.65	16	1-1/8	1.93	49
1J743-12-8	3/4	1-3/16x12	1/2	3.57	91	0.82	21	1-3/8	2.31	59
1J743-12-10	3/4	1-3/16x12	5/8	3.62	92	0.83	21	1-3/8	2.18	55
1J743-12-12	3/4	1-3/16x12	3/4	3.63	92	0.83	21	1-3/8	2.19	56
1J743-12-12-SM	3/4	1-3/16x12	3/4	3.63	92	0.83	21	36 mm	2.19	56
1J743-12-16	3/4	1-3/16x12	1	3.67	93	0.81	21	1-3/8	2.05	52
1J743-16-12	1	1-7/16x12	3/4	4.02	102	0.94	24	1-5/8	2.59	66
1J743-16-16	1	1-7/16x12	1	4.38	111	0.94	24	1-5/8	2.76	70
1J743-16-20	1	1-7/16x12	1-1/4	4.59	117	0.94	24	1-5/8	2.94	75
1J743-20-16	1-1/4	1-11/16x12	1	4.52	115	1.00	25	1-7/8	2.93	74
1J743-20-20	1-1/4	1-11/16x12	1-1/4	4.78	121	1.00	25	1-7/8	3.09	78
1J743-24-20	1-1/2	2x12	1-1/4	4.99	127	1.11	28	2-1/4	3.30	84
1J743-24-24	1-1/2	2x12	1-1/2	4.70	119	1.07	27	2-1/4	3.33	85

See Accessories Section for O-Rings.

1J943

Female Seal-Lok® - Swivel - 90° Elbow - Short Drop
ISO 12151-1 - SWES90

# Part Number	Thread		Hose I.D. inch	A		E		B		
	inch	9/16x18		inch	mm	inch	mm	inch	inch	mm
1J943-4-4	1/4	9/16x18	1/4	1.78	45	0.83	21	11/16	1.03	26
1J943-4-6	1/4	9/16x18	3/8	2.05	52	0.83	21	11/16	1.02	26
1J943-6-4	3/8	11/16x16	1/4	1.93	49	0.91	23	13/16	1.18	30
1J943-6-5	3/8	11/16x16	5/16	2.25	57	0.90	23	13/16	1.50	38
1J943-6-6	3/8	11/16x16	3/8	2.21	56	0.91	23	13/16	1.18	30
1J943-6-8	3/8	11/16x16	1/2	2.53	64	0.90	23	13/16	1.27	32
1J943-8-4	1/2	13/16x16	1/4	2.28	58	1.15	29	15/16	1.53	39
1J943-8-6	1/2	13/16x16	3/8	2.28	58	1.14	29	15/16	1.25	32
1J943-8-8	1/2	13/16x16	1/2	2.59	66	1.14	29	15/16	1.33	34
1J943-8-8-SM	1/2	13/16x16	1/2	2.59	66	1.14	29	24 mm	1.33	34
1J943-8-10	1/2	13/16x16	5/8	2.81	71	1.15	29	15/16	1.37	35
1J943-10-8	5/8	1x14	1/2	2.74	70	1.26	32	1-1/8	1.48	38
1J943-10-10	5/8	1x14	5/8	2.97	75	1.26	32	1-1/8	1.53	39
1J943-10-10-SM	5/8	1x14	5/8	2.97	75	1.26	32	30 mm	1.53	39
1J943-10-12	5/8	1x14	3/4	3.08	78	1.27	32	1-1/8	1.64	42
1J943-12-8	3/4	1-3/16x12	1/2	3.21	82	1.89	48	1-3/8	1.95	50
1J943-12-10	3/4	1-3/16x12	5/8	3.49	89	1.89	48	1-3/8	2.05	52
1J943-12-12	3/4	1-3/16x12	3/4	3.06	78	1.89	48	1-3/8	2.05	52
1J943-12-16	3/4	1-3/16x12	1	3.88	99	1.89	48	1-3/8	2.26	57
1J943-16-12	1	1-7/16x12	3/4	4.06	103	2.22	56	1-5/8	2.62	67
1J943-16-16	1	1-7/16x12	1	4.31	109	2.20	56	1-5/8	2.69	68
1J943-16-20	1	1-7/16x12	1-1/4	4.56	116	2.21	56	1-5/8	2.87	73
1J943-20-16	1-1/4	1-11/16x12	1	4.64	118	2.54	65	1-7/8	3.02	80
1J943-20-20	1-1/4	1-11/16x12	1-1/4	4.88	124	2.51	64	1-7/8	3.19	81
1J943-24-20	1-1/2	2x12	1-1/4	4.97	126	2.70	69	2-1/4	3.32	84
1J943-24-24	1-1/2	2x12	1-1/2	5.50	140	2.68	68	2-1/4	4.13	105

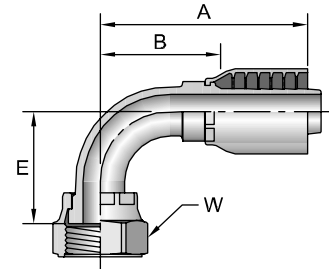

1J543

Female Seal-Lok® - Swivel - 90° Elbow - Medium Drop
ISO 12151-1 - SWEM90

# Part Number	Thread		Hose I.D. inch	A		E		B		
	inch	9/16x18		inch	mm	inch	mm	inch	inch	mm
1J543-4-4	1/4	9/16x18	1/4	2.07	53	1.26	32	11/16	1.32	34
1J543-6-4	3/8	11/16x16	1/4	2.12	54	1.50	38	13/16	1.37	35
1J543-6-6	3/8	11/16x16	3/8	2.40	61	1.50	38	13/16	1.37	35
1J543-6-6-SM	3/8	11/16x16	3/8	2.40	61	1.50	38	22 mm	1.37	35
1J543-8-6	1/2	13/16x16	3/8	2.48	63	1.61	41	15/16	1.45	37
1J543-8-8	1/2	13/16x16	1/2	2.59	66	1.61	41	15/16	1.33	34
1J543-10-8	5/8	1x14	1/2	2.74	70	1.85	47	1-1/8	1.48	38
1J543-10-10	5/8	1x14	5/8	2.97	75	1.85	47	1-1/8	1.53	39
1J543-10-12	5/8	1x14	3/4	3.12	79	1.88	48	1-1/8	1.68	43
1J543-12-12	3/4	1-3/16x12	3/4	3.49	89	2.28	58	1-3/8	2.05	52
1J543-16-16	1	1-7/16x12	1	4.86	123	2.78	71	1-5/8	3.27	83
1J543-20-20	1-1/4	1-11/16x12	1-1/4	4.89	124	3.09	78	1-7/8	3.20	81

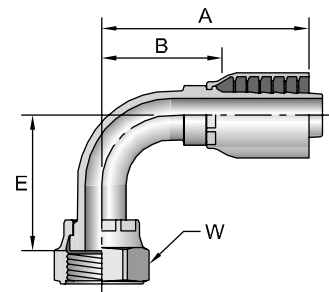

See Accessories Section for O-Rings.

1J143

Female Seal-Lok® - Swivel - 90° Elbow - Long Drop

ISO 12151-1 - SWEL90

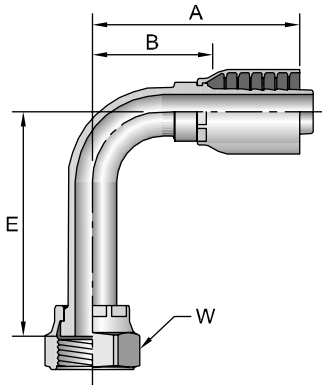

# Part Number	Thread		Hose I.D. inch	A		E		W inch	B	
	inch	inch		inch	mm	inch	mm		inch	mm
1J143-4-4	1/4	9/16x18	1/4	2.02	51	1.81	46	11/16	1.27	32
1J143-6-4	3/8	11/16x16	1/4	2.26	57	2.29	58	13/16	1.51	38
1J143-6-6	3/8	11/16x16	3/8	2.39	61	2.13	54	13/16	1.36	35
1J143-8-6	1/2	13/16x16	3/8	2.45	62	2.52	64	15/16	1.42	36
1J143-8-8	1/2	13/16x16	1/2	2.59	66	2.52	64	15/16	1.33	34
1J143-8-8-SM	1/2	13/16x16	1/2	2.59	66	2.52	64	24 mm	1.33	34
1J143-10-8	5/8	1x14	1/2	2.74	70	2.79	71	1-1/8	1.48	38
1J143-10-10	5/8	1x14	5/8	2.97	75	2.76	70	1-1/8	1.53	39
1J143-10-12	5/8	1x14	3/4	3.15	80	2.76	70	1-1/8	1.73	44
1J143-12-12	3/4	1-3/16x12	3/4	3.49	89	3.78	96	1-3/8	2.05	52
1J143-16-16	1	1-7/16x12	1	4.28	109	4.49	114	1-5/8	2.66	68
1J143-20-20	1-1/4	1-11/16x12	1-1/4	4.84	123	5.09	129	1-7/8	3.15	80
1J143-24-20	1-1/2	2x12	1-1/4	4.77	121	5.54	141	2-1/4	3.12	79

A

B

C

D

E

Universal Push-to-Connect (UPTC) Introduction

Traditionally, the fluid power industry has used threaded connectors to make a leak free connection. The speed of making connections is slow and the reliability of the connection is dependent on proper assembly procedures. Parker's UPTC connectors rely on a mechanical retaining mechanism (other than threads) to create a seal.

Tools are not required for assembly, and the reliability and speed of making connections with the UPTC design is greatly improved compared to traditional threaded connections.

Design and Construction

UPTC Seal-Lok consists of a base Seal-Lok ORFS fitting, a UPTC nut (including internal sealing and retaining elements), a dust O-Ring, and a UPTC hose assembly or rigid tube, as shown in figure 1. The base ORFS fitting is a highly reliable and widely available off-the-shelf standard SAE J1453 adapter. The sealing O-Ring is supported by a pressure energized anti-extrusion ring that prevents O-Ring extrusion and ensures tight sealing even under high pressure.

Once fully engaged, the retaining element is positively trapped between the male and UPTC nut. The dust O-Ring keeps contamination out and serves as a full engagement visual indicator. A clear tactile feeling at the end of the push indicates a proper connection. Once a proper connection is made, the dust O-Ring is covered by the UPTC nut. This also serves as a positive visual indicator of full engagement for easy inspection and quality control.

Once connected, the UPTC nut is permanently attached to the UPTC hose end similar to a traditional swivel nut. To disconnect, just use a wrench to unscrew the UPTC nut from the base adapter. Re-connect is possible by tightening the UPTC nut back to the base adapter, if the connection is not damaged. If the hose or tube is damaged, they can be replaced by installing a new UPTC assembly or a readily available standard Seal-Lok ORFS hose or tube assembly.

Features

- Available in sizes 1/4", 3/8", 1/2", 5/8", and 3/4"
- Uses standard Seal-Lok adapters for a wide variety of configurations, as well as excellent field serviceability
- Meets or exceeds SAE 100R2 pressure ratings (see Fig. 2)
- Includes visual and tactile installation indicators
- Seal-aligning nipple eliminates hose twist during assembly
- No special tooling required for disassembly
- Uses elastomeric seals, including Parker's patented Trap-Seal



Fig. 1a

Fig. 1b

Fig. 1a — This is a Tube Fittings Division part. Information can be found in Catalog 4300.

UPTC Pressure Ratings

Size	Pressure (psi)	Pressure (Bar)
-4	5800	400
-6	5000	345
-8	4250	293
-10	4000	276
-12	3125	216

A

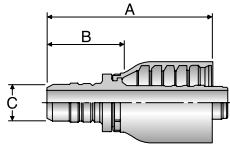

1EN43 UPTC Male

Part Number	Hose End Size inch	A inch	B inch	inch	C Nominal Connection Size mm
1EN43-8-4	1/4	1.83	1.08	0.31	8
1EN43-12-6	3/8	2.15	1.12	0.47	12
1EN43-15-8	1/2	2.51	1.25	0.59	15
1EN43-18-10	5/8	2.78	1.34	0.71	18
1EN43-22-12	3/4	2.81	1.37	0.87	22

B

1ET43 UPTC Male 90° Elbow

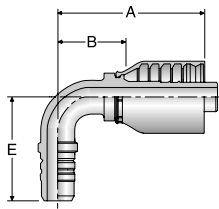

Part Number	Hose End Size inch	A inch	B inch	inch	C Nominal Connection Size mm	E inch
1ET43-8-4	1/4	1.78	1.03	0.31	8	1.54
1ET43-12-6	3/8	2.21	1.18	0.47	12	1.54
1ET43-15-8	1/2	2.51	1.25	0.59	15	1.77
1ET43-18-10	5/8	2.97	1.53	0.71	18	2.24
1ET43-22-12	3/4	3.43	1.99	0.87	22	2.50

C

D

1EU43 UPTC Male 45° Elbow

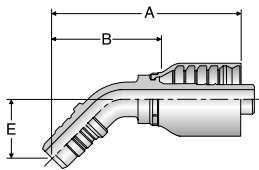

Part Number	Hose End Size inch	A inch	B inch	inch	C Nominal Connection Size mm	E inch
1EU43-8-4	1/4	2.48	1.73	0.31	8	0.91
1EU43-12-6	3/8	2.83	1.80	0.47	12	0.91
1EU43-15-8	1/2	3.17	1.91	0.59	15	0.99
1EU43-18-10	5/8	3.68	2.24	0.71	18	1.26
1EU43-22-12	3/4	3.76	2.32	0.87	22	1.30

E

1D043

Male Metric L - Rigid - (24° Cone)

ISO 12151-2

# Part Number	Thread		Hose I.D. inch	A		H mm	B	
	mm	mm		inch	mm		inch	mm
1D043-6-4	6	M12x1,5	1/4	1.73	44	14	0.93	24
1D043-8-4	8	M14x1,5	1/4	1.61	41	14	0.93	24
1D043-10-5	10	M16x1,5	5/16	1.97	50	19	0.83	21
1D043-10-6	10	M16x1,5	3/8	1.97	50	19	0.83	21
1D043-12-5	12	M18x1,5	5/16	1.89	48	19	0.94	24
1D043-12-6	12	M18x1,5	3/8	1.97	50	19	0.83	21
1D043-15-6	15	M22x1,5	3/8	1.93	49	22	1.02	26
1D043-15-8	15	M22x1,5	1/2	2.28	58	22	0.94	24
1D043-18-10	18	M26x1,5	5/8	2.68	68	27	1.14	29
1D043-18-12	18	M26x1,5	3/4	2.68	68	27	1.14	29
1D043-22-12	22	M30x2	3/4	2.72	69	30	1.22	31
1D043-28-16	28	M36x2	1	3.11	79	36	1.30	33
1D043-35-20	35	M45x2	1-1/4	3.35	85	46	1.50	38

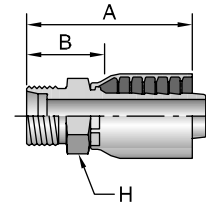

11D43

Male Standpipe Metric L - Rigid

End Connection per ISO 8434-1-SDS

# Part Number	R mm	Hose I.D. inch	A		D		B	
			inch	mm	inch	mm	inch	mm
11D43-6-4	6	1/4	2.03	52	0.87	22	1.28	33
11D43-10-5	10	5/16	2.36	60	0.91	23	1.45	37
11D43-10-6	10	3/8	2.28	58	0.91	23	1.14	29
11D43-12-4	12	1/4	2.17	55	0.91	23	1.22	31
11D43-15-8	15	1/2	2.56	65	0.98	25	1.22	31
11D43-18-10	18	5/8	2.99	76	1.02	26	1.48	38
11D43-18-12	18	3/4	2.80	71	1.02	26	1.22	31
11D43-22-12	22	3/4	2.87	73	1.10	28	1.26	32
11D43-28-16	28	1	3.31	84	1.18	30	1.46	37

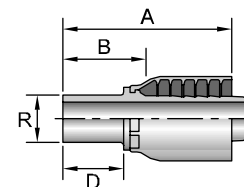

Metric L: Mates with EO "L" Series Fittings. See Accessories Section for O-Rings.

1C343 Female Metric L - Swivel - (Ball Nose)

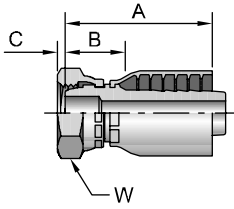

# Part Number	Thread		Hose I.D. inch	A		C		W mm	B	
	mm			inch	mm	inch	mm		inch	mm
1C343-6-4	6	M12x1,5	1/4	1.75	44	0.09	2	14	1.16	29
1C343-8-4	8	M14x1,5	1/4	1.77	45	0.11	3	17	1.16	29
1C343-10-5	10	M16x1,5	5/16	2.01	51	0.06	2	19	1.20	30
1C343-10-6	10	M16x1,5	3/8	2.06	52	0.06	2	19	1.10	28
1C343-12-5	12	M18x1,5	5/16	1.87	47	0.10	3	22	0.70	18
1C343-12-6	12	M18x1,5	3/8	2.23	57	0.10	3	22	1.18	30
1C343-15-6	6	M22x1,5	3/8	1.85	47	0.16	4	27	0.71	18
1C343-15-8	15	M22x1,5	1/2	2.42	61	0.17	4	27	1.29	33
1C343-18-10	18	M26x1,5	5/8	2.65	67	0.10	3	32	1.23	31
1C343-18-12	18	M26x1,5	3/4	2.80	71	0.10	3	32	1.37	35
1C343-22-12	22	M30x2	3/4	2.87	73	0.18	5	36	1.42	36
1C343-28-16	28	M36x2	1	3.35	85	0.22	6	46	1.76	45

When measuring overall length to the end of the nut, B+C dimensions must be used to calculate cut-off allowance.

1C443 Female Metric L - Swivel - 45° Elbow - (Ball Nose)

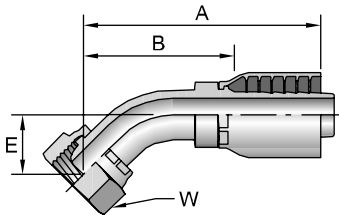

# Part Number	Thread		Hose I.D. inch	A		E		W mm	B	
	mm			inch	mm	inch	mm		inch	mm
1C443-8-4	8	M14x1,5	1/4	2.40	61	0.59	15	17	1.50	38
1C443-10-5	10	M16x1,5	5/16	2.60	66	0.67	17	19	1.61	41
1C443-10-6	10	M16x1,5	3/8	2.76	70	0.67	17	19	1.61	41
1C443-12-6	12	M18x1,5	3/8	2.76	70	0.67	17	22	1.61	41
1C443-15-8	15	M22x1,5	1/2	3.35	85	0.79	20	27	1.97	50
1C443-18-10	18	M26x1,5	5/8	4.09	104	1.14	29	32	2.52	64
1C443-22-12	22	M30x2	3/4	3.78	96	0.91	23	36	2.20	56
1C443-28-16	28	M36x2	1	4.53	115	1.10	28	46	2.81	71

1C543 Female Metric L - Swivel - 90° Elbow - (Ball Nose)

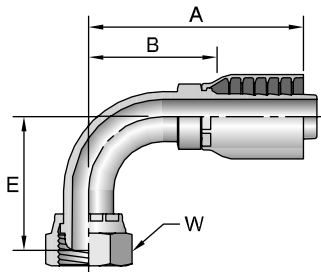

# Part Number	Thread		Hose I.D. inch	A		E		W mm	B	
	mm			inch	mm	inch	mm		inch	mm
1C543-8-4	8	M14x1,5	1/4	2.05	52	1.10	28	17	1.18	30
1C543-10-5	10	M16x1,5	5/16	2.20	56	1.18	30	19	1.22	31
1C543-10-6	10	M16x1,5	3/8	2.40	61	1.18	30	19	1.40	36
1C543-12-6	12	M18x1,5	3/8	2.40	61	1.22	31	22	1.40	36
1C543-15-8	15	M22x1,5	1/2	2.95	75	1.57	40	27	1.57	40
1C543-18-10	18	M26x1,5	5/8	3.58	91	2.36	60	32	2.05	52
1C543-22-12	22	M30x2	3/4	3.58	91	1.97	50	36	2.00	51
1C543-28-16	28	M36x2	1	4.33	110	2.48	63	46	2.56	65

Metric L: Mates with EO "L" Series Fittings.

1CA43

Female Metric L - Swivel - (24° Cone with O-Ring)

ISO 12151-2 - SWS

# Part Number	Thread mm	Hose I.D. inch	A		C		W mm	B	
			inch	mm	inch	mm		inch	mm
1CA43-6-4	6	M12x1,5	1/4	1.73	44	-0.02	14	0.88	22
1CA43-8-4	8	M14x1,5	1/4	1.73	44	-0.01	17	0.88	22
1CA43-8-5	8	M14x1,5	5/16	1.97	50	0.00	17	1.02	26
1CA43-10-4	10	M16x1,5	1/4	1.81	46	0.04	19	0.87	22
1CA43-10-5	10	M16x1,5	5/16	1.81	46	0.04	19	0.87	22
1CA43-12-5	12	M18x1,5	5/16	1.81	46	0.04	22	0.91	23
1CA43-12-6	12	M18x1,5	3/8	1.89	48	0.03	22	0.75	19
1CA43-15-8	15	M22x1,5	1/2	2.20	56	0.07	27	0.82	21
1CA43-18-10	18	M26x1,5	5/8	2.44	62	0.02	32	0.87	22
1CA43-18-12	18	M26x1,5	3/4	2.56	65	0.02	32	1.02	26
1CA43-22-12	22	M30x2	3/4	2.48	63	0.13	36	0.94	24
1CA43-28-16	28	M36x2	1	3.07	78	0.14	41	1.30	33
1CA43-35-20	35	M45x2	1-1/4	3.23	82	0.00	50	1.38	35

When measuring overall length to the end of the nut, B+C dimensions must be used to calculate cut-off allowance.

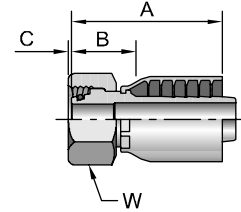

1CE43

Female Metric L - Swivel - 45° Elbow - (24° Cone with O-Ring)

ISO 12151-2 - SWE45

# Part Number	Thread mm	Hose I.D. inch	A		E		W mm	B	
			inch	mm	inch	mm		inch	mm
1CE43-6-4	6	M12x1,5	1/4	2.68	68	0.75	19	1.77	45
1CE43-8-4	8	M14x1,5	1/4	2.32	59	0.63	16	1.38	35
1CE43-10-5	10	M16x1,5	5/16	2.64	67	0.59	15	1.69	43
1CE43-10-6	10	M16x1,5	3/8	2.95	75	0.75	19	1.85	47
1CE43-12-6	12	M18x1,5	3/8	2.72	69	0.75	19	1.53	39
1CE43-15-8	15	M22x1,5	1/2	3.19	81	0.87	22	1.81	46
1CE43-18-10	18	M26x1,5	5/8	3.50	89	0.91	23	1.93	49
1CE43-22-12	22	M30x2	3/4	3.86	98	1.02	26	2.28	58

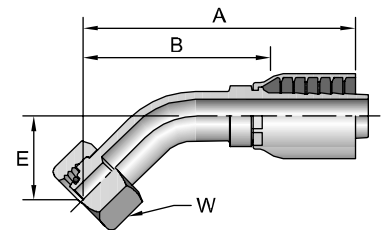

1CF43

Female Metric L - Swivel - 90° Elbow - (24° Cone with O-Ring)

ISO 12151-2 - SWE

# Part Number	Thread mm	Hose I.D. inch	A		E		W mm	B	
			inch	mm	inch	mm		inch	mm
1CF43-8-4	8	M14x1,5	1/4	2.01	51	1.14	29	1.10	28
1CF43-10-5	10	M16x1,5	5/16	2.40	61	1.16	29	1.46	37
1CF43-10-6	10	M16x1,5	3/8	2.56	65	1.38	35	1.46	37
1CF43-12-5	12	M18x1,5	5/16	2.40	61	1.18	30	1.46	37
1CF43-12-6	12	M18x1,5	3/8	2.52	64	1.42	36	1.38	35
1CF43-15-8	15	M22x1,5	1/2	2.80	71	1.69	43	1.46	37
1CF43-18-10	18	M26x1,5	5/8	3.17	81	1.77	45	1.61	41
1CF43-22-12	22	M30x2	3/4	3.50	89	2.17	55	1.93	49
1CF43-35-20	35	M45x2	1-1/4	5.12	130	3.11	79	3.27	83

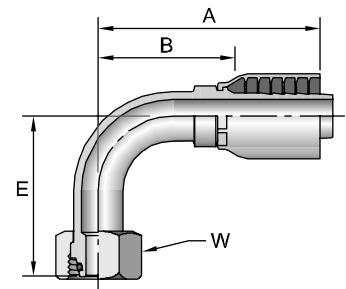

Metric L: Mates with EO "L" Series Fittings.

1D243

Male Metric S - Rigid - (24° Cone)

ISO 12151-2

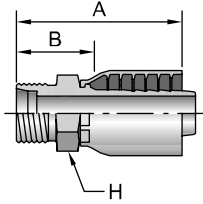

# Part Number	Thread		Hose I.D. inch	A		H mm	B	
	mm	mm		inch	mm		inch	mm
1D243-8-4	8	M16x1,5	1/4	1.73	44	17	0.87	22
1D243-10-4	10	M18x1,5	1/4	1.73	44	19	0.87	22
1D243-12-5	12	M20x1,5	5/16	2.20	56	22	1.29	33
1D243-12-6	12	M20x1,5	3/8	1.97	50	22	1.02	26
1D243-14-6	14	M22x1,5	3/8	2.17	55	22	0.98	25
1D243-16-8	16	M24x1,5	1/2	2.36	60	24	1.17	30
1D243-20-10	20	M30x2	5/8	2.95	75	30	1.44	37
1D243-25-12	25	M36x2	3/4	2.87	73	36	1.30	33
1D243-30-16	30	M42x2	1	3.39	86	46	1.54	39

13D43

Male Standpipe Metric S - Rigid

End Connection per ISO 8434-1-SDS

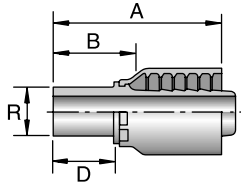

# Part Number	R mm	Hose I.D. inch	A		D		B	
			inch	mm	inch	mm	inch	mm
13D43-10-4	10	1/4	2.13	54	1.02	26	1.26	32
13D43-12-5	12	5/16	2.52	64	1.02	26	1.61	41
13D43-14-6	14	3/8	2.52	64	1.14	29	1.38	35
13D43-16-8	16	1/2	2.68	68	1.18	30	1.42	36
13D43-20-10	20	5/8	3.39	86	1.42	36	1.88	48
13D43-20-12	20	3/4	3.19	81	1.42	36	1.57	40
13D43-25-12	25	3/4	3.35	85	1.57	40	1.73	44
13D43-30-16	30	1	3.82	97	1.73	44	2.01	51

Light Series 11D43-6-4, 11D43-8-4 and 11D43-12-6 are used in place of their Heavy Series equivalent size and accept the EO Heavy "S" Series ferrules and nuts.

1C643

Female Metric S - Swivel - (Ball Nose)

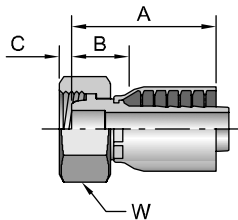

# Part Number	Thread		Hose I.D. inch	A		C		W mm	B	
	mm	mm		inch	mm	inch	mm		inch	mm
1C643-8-4	8	M16x1,5	1/4	1.57	40	0.15	4	19	1.20	30
1C643-10-4	10	M18x1,5	1/4	1.63	41	0.10	3	22	1.20	30
1C643-12-5	12	M20x1,5	5/16	1.87	47	0.08	2	24	1.20	30
1C643-12-6	12	M20x1,5	3/8	1.76	45	0.08	2	24	1.32	34
1C643-12-8	12	M20x1,5	1/2	2.18	55	0.08	2	24	1.30	33
1C643-14-6	14	M22x1,5	3/8	1.94	49	0.17	4	27	1.32	34
1C643-16-8	16	M24x1,5	1/2	2.13	54	0.19	5	30	1.39	35
1C643-20-10	20	M30x2	5/8	2.38	60	0.21	5	36	1.39	35
1C643-20-12	20	M30x2	3/4	2.46	62	0.21	5	40	1.03	37
1C643-25-12	25	M36x2	3/4	2.48	63	0.28	7	46	1.56	40
1C643-30-16	30	M42x2	1	2.89	73	0.37	9	50	1.95	50

Metric L: Mates with EO "L" Series Fittings.

Metric S: Mates with EO "S" Series Fittings.

1C043

Female Metric - Swivel - (Ball Nose)

# Part Number	Thread		Hose I.D. inch	A		C		W mm	B	
	mm	mm		inch	mm	inch	mm		inch	mm
1C043-20-12	20	M30x1,5	3/4	2.48	63	0.21	5	36	0.94	24
1C043-25-16	25	M38x1,5	1	2.99	76	0.28	7	46	1.14	29

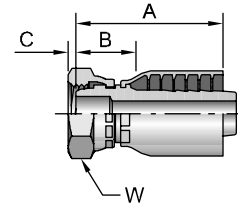

1C943

Female Metric S - Swivel - (24° Cone with O-Ring)

ISO 12151-2 - SWS

# Part Number	Thread		Hose I.D. inch	A		C		W mm	B	
	mm	mm		inch	mm	inch	mm		inch	mm
1C943-6-4	6	M14x1,5	1/4	1.89	48	0.01	0	17	1.02	26
1C943-8-4	8	M16x1,5	1/4	1.77	45	0.01	0	19	0.91	23
1C943-10-4	10	M18x1,5	1/4	1.81	46	0.01	0	22	0.87	22
1C943-10-5	10	M18x1,5	5/16	1.85	47	0.01	0	22	0.87	22
1C943-10-6	10	M18x1,5	3/8	1.97	50	0.01	0	22	0.83	21
1C943-12-5	12	M20x1,5	5/16	1.89	48	0.03	1	24	0.94	24
1C943-12-6	12	M20x1,5	3/8	2.05	52	0.03	1	24	0.87	22
1C943-14-6	14	M22x1,5	3/8	1.97	50	0.03	1	27	0.83	21
1C943-16-8	16	M24x1,5	1/2	2.33	59	0.09	2	30	0.94	24
1C943-20-10	20	M30x2	5/8	2.59	66	0.05	1	36	1.06	27
1C943-20-12	20	M30x2	3/4	2.59	66	0.05	1	36	1.06	27
1C943-25-12	25	M36x2	3/4	2.67	68	0.10	3	46	1.10	28
1C943-25-16	25	M36x2	1	3.07	78	0.08	2	46	1.30	33
1C943-30-16	30	M42x2	1	3.03	77	0.19	5	50	1.26	32
1C943-38-20	38	M52x2	1-1/4	3.15	80	0.23	6	60	1.30	33

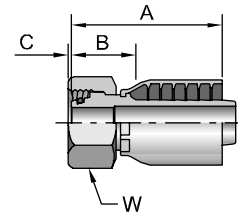

10C43

Female Metric S - Swivel - 45° Elbow - (24° Cone with O-Ring)

ISO 12151-2 - SWE45

# Part Number	Thread		Hose I.D. inch	A		E		W mm	B	
	mm	mm		inch	mm	inch	mm		inch	mm
10C43-8-4	8	M16x1,5	1/4	2.32	59	0.63	16	19	1.38	35
10C43-12-5	12	M20x1,5	5/16	2.80	71	0.67	17	24	1.85	47
10C43-12-6	12	M20x1,5	3/8	2.72	69	0.79	20	24	1.57	40
10C43-16-8	16	M24x1,5	1/2	3.23	82	0.94	24	30	1.89	48
10C43-20-10	20	M30x2	5/8	3.58	91	0.98	25	36	2.05	52
10C43-20-12	20	M30x2	3/4	3.94	100	1.14	29	36	2.36	60
10C43-25-12	25	M36x2	3/4	3.97	101	1.18	30	46	2.40	61
10C43-30-16	30	M42x2	1	4.96	126	1.42	36	50	3.11	79
10C43-38-20 ^{^^}	38	M52x2	1-1/4	5.59	142	1.50	38	60	3.74	95

^{^^}Must be assembled with Die Part No. 83C-A20H in a Superkrimp or Parkrimp 2.

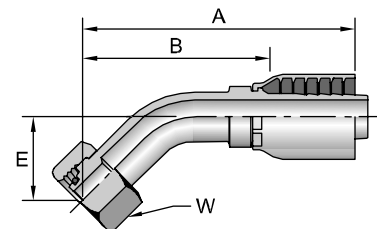

11C43

Female Metric S - Swivel - 90° Elbow - (24° Cone with O-Ring)
ISO 12151-2 - SWE

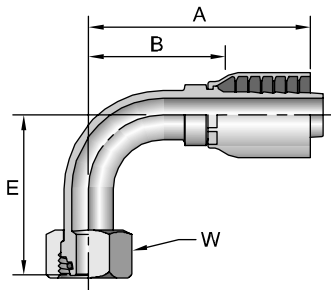

# Part Number	Thread		Hose I.D. inch	A		E		W mm	B	
	mm	mm		inch	mm	inch	mm		inch	mm
11C43-8-4	8	M16x1,5	1/4	1.89	48	1.14	29	19	1.02	26
11C43-10-4	10	M18x1,5	1/4	1.97	50	1.14	29	22	1.02	26
11C43-12-5	12	M20x1,5	5/16	2.36	60	1.26	32	24	1.42	36
11C43-12-6	12	M20x1,5	3/8	2.56	65	1.46	37	24	1.38	35
11C43-14-6	14	M22x1,5	3/8	2.56	65	1.46	37	27	1.38	35
11C43-16-8	16	M24x1,5	1/2	2.83	72	1.77	45	30	1.46	37
11C43-20-10	20	M30x2	5/8	3.11	79	1.89	48	36	1.57	40
11C43-25-12	25	M36x2	3/4	3.50	89	2.32	59	46	1.93	49
11C43-30-16	30	M42x2	1	4.53	115	2.99	76	50	2.68	68
11C43-38-20 ^{^^}	38	M52x2	1-1/4	5.12	130	3.15	80	60	3.27	83

^{^^}Must be assembled with Die Part No. 83C-A20H in a Superkrimp or Parkrimp 2.

1D943

Male BSP Parallel Pipe - Rigid - (60° Cone)
ISO 12151-6

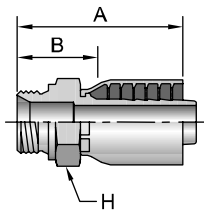

# Part Number	Thread		Hose I.D. inch	A		H mm	B	
	inch	mm		inch	mm		inch	mm
1D943-4-4	1/4x19		1/4	1.77	45	19	0.91	23
1D943-6-5	3/8x19		5/16	2.13	54	22	1.22	31
1D943-6-6	3/8x19		3/8	2.13	54	22	1.22	31
1D943-8-6	1/2x14		3/8	2.36	60	27	1.22	31
1D943-8-8	1/2x14		1/2	2.44	62	27	1.10	28
1D943-12-12	3/4x14		3/4	2.76	70	32	1.18	30
1D943-16-16	1x11		1	3.23	82	41	1.38	35

When used in a port, a bonded seal must be used. See Accessories Section for more information.

19243

Female BSP Parallel Pipe - Swivel - (60° Cone)
ISO 12151-6

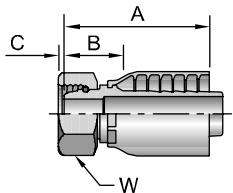

# Part Number	Thread		Hose I.D. inch	A		C		W mm	B	
	inch	mm		inch	mm	inch	mm		inch	mm
19243-2-4	1/8x28		1/4	1.61	41	0.20	5	14	0.67	17
19243-4-4	1/4x19		1/4	1.95	50	0.22	6	19	1.20	30
19243-6-4	3/8x19		1/4	1.73	44	0.26	7	22	0.79	20
19243-6-6	3/8x19		3/8	2.35	60	0.26	7	22	1.32	34
19243-6-8	3/8x19		1/2	2.17	55	0.26	7	22	0.79	20
19243-8-6	1/2x14		3/8	2.01	51	0.28	7	27	0.87	22
19243-8-8	1/2x14		1/2	2.72	69	0.28	7	27	1.46	37
19243-10-8	5/8x14		1/2	2.80	71	0.37	9	30	1.54	39
19243-10-10	5/8x14		5/8	2.99	76	0.37	9	30	1.55	39
19243-12-10	3/4x14		5/8	3.11	79	0.35	9	36	1.67	42
19243-12-12	3/4x14		3/4	3.19	81	0.35	9	36	1.75	44
19243-16-16	1x11		1	3.67	93	0.44	11	41	2.05	52
19243-20-20	1-1/4x11		1-1/4	3.11	79	0.41	11	50	1.26	32

When measuring overall length to the end of the nut, B+C dimensions must be used to calculate cut-off allowance.

1B143

Female BSP Parallel Pipe - Swivel - 45° Elbow - (60° Cone)

ISO 12151-6

# Part Number	Thread inch	Hose I.D. inch	A		E		W mm	B	
			inch	mm	inch	mm		inch	mm
1B143-4-4	1/4x19	1/4	2.26	57	0.61	15	19	1.51	38
1B143-6-6	3/8x19	3/8	2.61	66	0.67	17	22	1.59	40
1B143-8-8	1/2x14	1/2	3.10	78	0.79	20	27	1.85	46
1B143-10-10	5/8x14	5/8	3.53	89	0.91	23	30	2.08	52
1B143-12-10	3/4x14	5/8	3.47	88	0.87	22	32	2.02	51
1B143-12-12	3/4x14	3/4	3.77	95	0.98	24	32	2.34	59
1B143-16-16	1x11	1	4.72	119	1.22	30	41	3.10	78

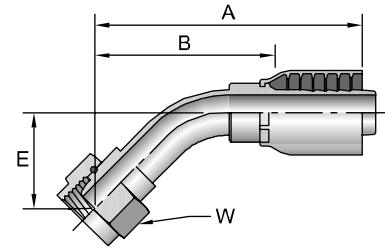

1B243

Female BSP Parallel Pipe - Swivel - 90° Elbow - (60° Cone)

ISO 12151-6

# Part Number	Thread inch	Hose I.D. inch	A		E		W mm	B	
			inch	mm	inch	mm		inch	mm
1B243-2-4	1/8x28	1/4	1.97	50	1.10	28	14	1.02	26
1B243-4-4	1/4x19	1/4	1.83	46	1.12	28	19	1.08	27
1B243-6-6	3/8x19	3/8	2.32	59	1.46	37	22	1.32	34
1B243-8-6	1/2x14	3/8	2.60	66	1.38	35	27	1.46	37
1B243-8-8	1/2x14	1/2	2.95	75	1.57	40	27	1.57	40
1B243-10-8	5/8x14	1/2	2.91	74	1.57	40	30	1.54	39
1B243-10-10	5/8x14	5/8	3.13	80	1.57	40	30	1.72	44
1B243-12-10	3/4x14	5/8	3.62	92	2.32	59	32	2.05	52
1B243-12-12	3/4x14	3/4	3.58	91	2.32	59	32	2.00	51
1B243-16-16	1x11	1	4.33	110	2.48	63	41	2.56	65
1B243-20-20	1-1/4x11	1-1/4	4.72	120	2.99	76	50	2.87	73

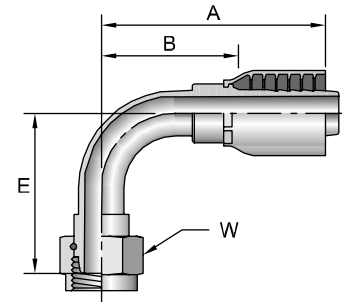

1B443

Female BSP Parallel Pipe - Swivel - 90° Elbow - Block Type - (60° Cone)

ISO 228-1

# Part Number	Thread inch	Hose I.D. inch	A		E		H	W	B	
			inch	mm	inch	mm	mm	mm	inch	mm
1B443-4-4	1/4x19	1/4	2.40	61	1.14	29	17	19	1.40	36
1B443-6-6	3/8x19	3/8	2.76	70	1.02	26	19	22	1.42	36
1B443-8-8	1/2x14	1/2	3.19	81	1.02	26	22	27	1.57	40
1B443-12-12	3/4x14	3/4	3.30	84	1.30	33	23	32	0.98	25

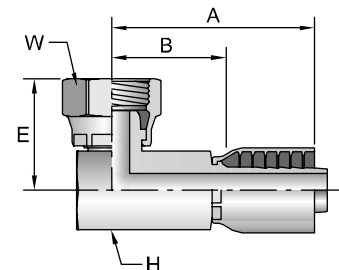

Metric S: Mates with EO "S" Series Fittings.

When measuring overall length to the end of the nut, B+C dimensions must be used to calculate cut-off allowance.

1B543

Female BSP Parallel Pipe - Swivel - (Flat Seat)

ISO 228-1

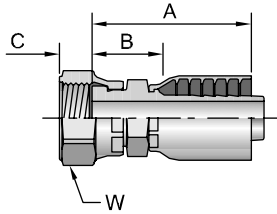

# Part Number	Thread inch	Hose I.D. inch	A inch mm		C inch mm		W mm	B inch mm	
1B543-6-6	3/8x19	3/8	1.93	49	0.35	9	22	0.79	20
1B543-8-6	1/2x14	3/8	1.89	48	0.43	11	27	0.75	19
1B543-8-8	1/2x14	1/2	2.28	58	0.43	11	27	0.94	24
1B543-12-12	3/4x14	3/4	2.28	58	0.33	8	32	0.94	24

When measuring overall length to the end of the nut, B+C dimensions must be used to calculate cut-off allowance.

14943

DIN Metric Banjo

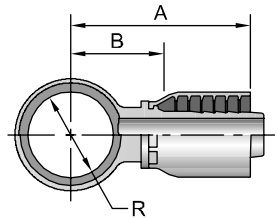

# Part Number	R mm	Hose I.D. inch	A inch mm		B inch mm	
14943-10-4	10		1.85	47	0.94	24
14943-12-4	12	1/4	1.85	47	0.98	25
14943-14-5	14	5/16	2.01	51	1.06	27
14943-16-6	16	3/8	2.28	58	1.14	29
14943-18-8	18	1/2	2.60	66	1.22	31
14943-22-10	22	5/8	2.91	74	1.38	35
14943-26-12	26	3/4	3.07	78	1.54	39

AM Banjo Bolt w/DIN Metric Thread

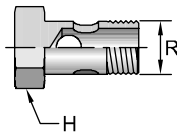

# Part Number	R Thread mm	H mm	Copper Washer 2
AM-03	8	M8x1	853009-8
AM-04	10	M10x1	853009-10
AM-06	12	M12x1,5	853009-12
AM-08	14	M14x1,5	853009-14
AM-10	16	M16x1,5	853009-16
AM-13	18	M18x1,5	853009-18
AM-16	22	M22x1,5	853009-22
AM-20	26	M26x1,5	853009-26
AM-30	30	M30x1,5	853009-30

Two (2) copper washers per bolt must be ordered separately.

Metric S: Mates with EO "S" Series Fittings.

1MU43

Female Metric - Swivel - (30° Flare)

# Part Number	Thread mm	Hose I.D. inch	A		H mm	W mm	B	
			inch	mm			inch	mm
1MU43-4-4	M14x1,5	1/4	2.07	53	19	19	1.32	34
1MU43-6-4	M18x1,5	1/4	2.18	55	24	24	1.43	36
1MU43-6-6	M18x1,5	3/8	2.45	62	24	24	1.42	36
1MU43-8-8	M22x1,5	1/2	2.84	72	27	27	1.58	40

Japanese Fittings - Female Swivel 30° Flare with Metric Threads. All 30° flared fitting sizes are available by combining the 1MU43 fittings in sizes up to -8 with the 1XU43 fittings in sizes -10 and larger.

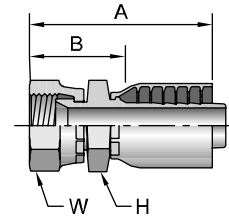

1XU43

Female Metric - Swivel - (30° Flare)

# Part Number	Thread mm	Hose I.D. inch	A		H mm	W mm	B	
			inch	mm			inch	mm
1XU43-10-10	M24x1,5	5/8	3.25	83	30	32	1.81	46
1XU43-12-12	M30x1,5	3/4	3.40	86	32	36	1.96	50
1XU43-16-16	M33x1,5	1	4.03	102	36	41	2.41	61
1XU43-20-20	M36x1,5	1-1/4	4.19	106	46	46	2.50	64
1XU43-24-24	M42x1,5	1-1/2	4.12	105	50	55	2.75	70

Japanese Fittings - Female Swivel 30° Flare with Metric Threads. All 30° flared fitting sizes are available by combining the 1MU43 fittings in sizes up to -8 with the 1XU43 fittings in sizes -10 and larger.

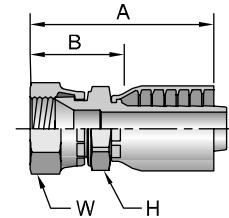

1FU43

Female BSP Parallel Pipe - Swivel - (30° Flare)

B8363 Code F

# Part Number	Thread inch	Hose I.D. inch	A		H mm	W mm	B	
			inch	mm			inch	mm
1FU43-4-4	1/4x19	1/4	1.90	48	19	19	1.15	29
1FU43-6-6	3/8x19	3/8	2.32	59	22	22	1.29	33
1FU43-8-8	1/2x14	1/2	2.66	68	27	27	1.40	36
1FU43-12-12	3/4x14	3/4	3.06	78	36	36	1.62	41
1FU43-16-16	1x11	1	3.53	90	41	41	1.91	49
1FU43-20-20	1-1/4x11	1-1/4	3.87	98	50	50	2.18	55

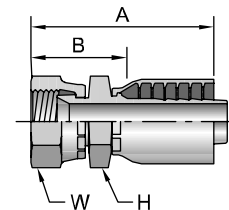

1UT43

Male BSP Taper Pipe - Rigid - (60° Cone)

B8363 Code R

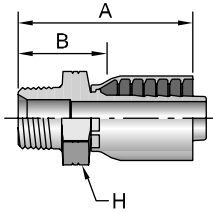

# Part Number	Thread inch	Hose I.D. inch	A		H		B	
			inch	mm	mm	inch	mm	
1UT43-4-4	1/4x19	1/4	1.92	49	19	1.17	30	
1UT43-6-6	3/8x19	3/8	2.25	57	22	1.22	31	
1UT43-8-8	1/2x14	1/2	2.68	68	27	1.42	36	
1UT43-12-12	3/4x14	3/4	2.96	75	36	1.53	39	
1UT43-16-16	1x11	1	3.48	88	41	1.86	47	
1UT43-20-20	1-1/4x11	1-1/4	3.75	95	50	2.10	53	

1GU43

Female BSP Parallel Pipe - Swivel - (60° Cone)

B8363 Code C

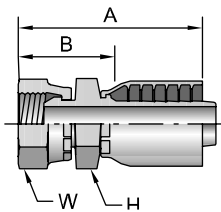

# Part Number	Thread inch	Hose I.D. inch	A		H	W	B	
			inch	mm	mm	mm	inch	mm
1GU43-4-4	1/4x19	1/4	2.08	53	19	19	1.33	34
1GU43-6-6	3/8x19	3/8	2.45	62	22	22	1.42	36
1GU43-8-8	1/2x14	1/2	2.81	71	27	27	1.56	40
1GU43-12-12	3/4x14	3/4	3.24	82	36	36	1.81	46
1GU43-16-16	1x11	1	3.74	95	41	41	2.12	54
1GU43-20-20	1-1/4x11	1-1/4	4.07	103	50	50	2.38	60





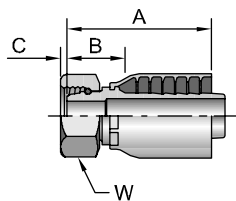





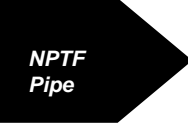
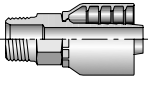

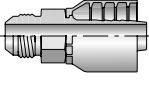
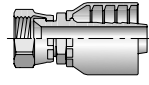
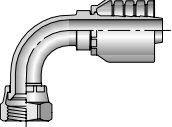

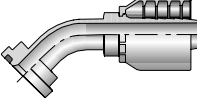
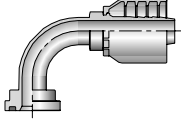
1F443

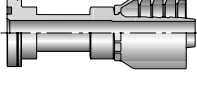
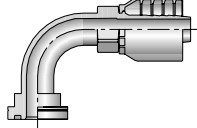
Female French Gaz Series - Swivel - (Ball Nose)

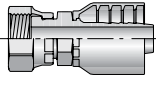
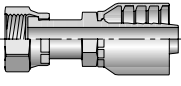
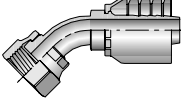
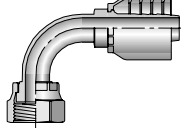
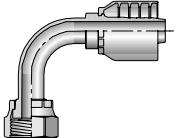
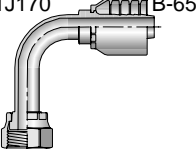

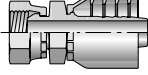
# Part Number	Thread mm	Hose I.D. inch	A		C		W	B	
			inch	mm	inch	mm	mm	inch	mm
1F443-27-12	27 M36x1,5	3/4	3	76	0.14	4	55	1.14	29

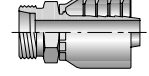
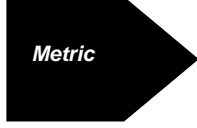
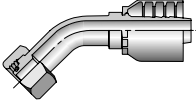
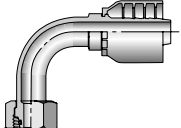
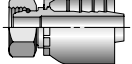
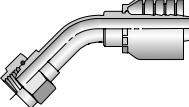
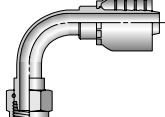
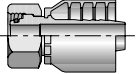
When measuring overall length to the end of the nut, B+C dimensions must be used to calculate cut-off allowance.

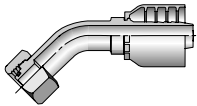
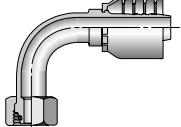
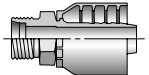
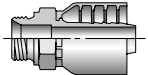
 NPTF Pipe	10170 B-62  Male - Rigid	 JIC 37°	10370 B-62  Male - Rigid	10670 B-62  Female - Swivel	13970 B-62  Female - Swivel 90° Elbow - Short
 Code 61 Flange	11770 B-63  45° Elbow	11970 B-63  90° Elbow	 Code 62 Flange	16A70 B-63  Flange Head	16N70 B-64  90° Elbow
 Seal-Lok® (O-Ring Face Seal)	1JC70 B-64  Female - Swivel Short	1JS70 B-64  Female - Swivel Long	1J770 B-64  Femal - Swivel 45° Elbow	1J970 B-65  Female - Swivel 90° Elbow - Short	1J570 B-65  Female - Swivel 90° Elbow - Medium
1J170 B-65  Female - Swivel 90° Elbow - Long	 BSP 60° Cone	1GU70 B-66  Female - Swivel	 French Gaz	1FG70 B-66  Male - Rigid	 Metric
10C70 B-67  Female Metric S - Swivel - 45° Elbow	11C70 B-67  Female Metric S - Swivel - 90° Elbow	19270 B-67  Female BSP - Swivel - 60° Cone	1B170 B-67  Female BSP - Swivel - 45° Elbow	1B270 B-68  Female BSP - Swivel - 90° Elbow	1C970 B-68  Female - Swivel
1CA70 B-68  Female Metric L - Swivel - 24° Cone	1CE70 B-68  Female Metric L - Swivel - 45° Elbow	1CF70 B-69  Female Metric L - Swivel - 90° Elbow	1D270 B-69  Male Metric S - Rigid	1D970 B-69  Male - BSP - Rigid	

A

B

C

D

E

A

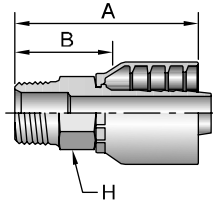

10170 Male NPTF Pipe - Rigid

# Part Number	Thread		Hose I.D.		A		H		B	
	inch		inch		inch	mm	inch	mm	inch	mm
10170-6-6	3/8x18		3/8		2.37	60	3/4		1.47	37
10170-8-8	1/2x14		1/2		2.84	72	7/8		1.40	36

B

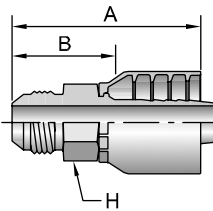

10370 Male JIC 37° - Rigid

# Part Number	Thread		Hose I.D.		A		H		B	
	inch		inch		inch	mm	inch	mm	inch	mm
10370-8-8	1/2	3/4x16	1/2		2.68	68	7/8		1.47	37
10370-10-8	5/8	7/8x14	1/2		2.62	66	15/16		1.41	36

C

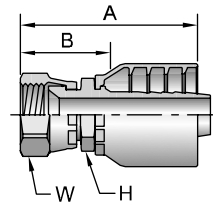

10670 Female JIC 37° - Swivel

# Part Number	Thread		Hose I.D.		A		H	W	B	
	inch		inch		inch	mm	inch	inch	inch	mm
10670-6-6	3/8	9/16x18	3/8		2.29	58	11/16	11/16	1.39	35
10670-8-8	1/2	3/4x16	1/2		2.62	67	13/16	7/8	1.41	36
10670-10-8	5/8	7/8x14	1/2		2.85	72	7/8	1	1.64	42
10670-10-10	5/8	7/8x14	5/8		2.84	72	15/16	1	1.59	40

D

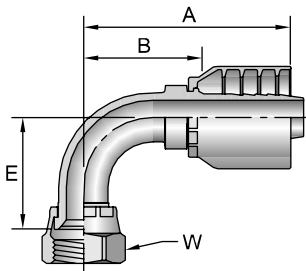

13970 Female JIC 37° - Swivel - 90° Elbow - Short Drop

# Part Number	Thread		Hose I.D.		A		E		W		B	
	inch		inch		inch	mm	inch	mm	inch	mm	inch	mm
13970-8-8	1/2	3/4x16	1/2		2.62	67	1.14	29	7/8		1.41	36

E

11770

SAE Code 61 Flange Head - 45° Elbow

ISO 12151-3 - 45S - L

# Part Number	Flange inch	Hose I.D. inch	A		E		F inch	B	
			inch	mm	inch	mm		inch	mm
11770-8-8	1/2	1/2	3.28	83	0.77	20	1-3/16	2.07	53
11770-12-10	3/4	5/8	3.37	86	0.76	19	1-1/2	2.12	54

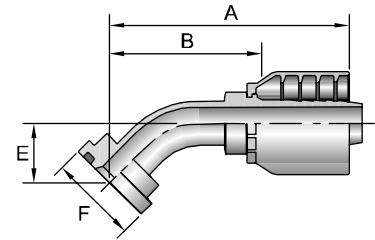

11970

SAE Code 61 Flange Head - 90° Elbow

ISO 12151-3 - E90S - L

# Part Number	Flange inch	Hose I.D. inch	A		E		F inch	B	
			inch	mm	inch	mm		inch	mm
11970-8-8	1/2	1/2	2.93	74	1.60	41	1-3/16	1.72	44
11970-12-10	3/4	5/8	3.54	90	2.02	51	1-1/2	2.29	58

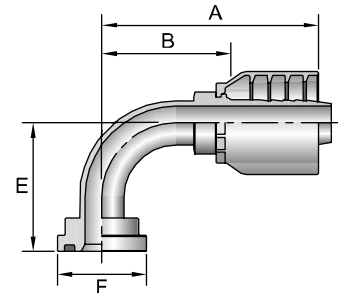

16A70

SAE Code 62 Flange Head

ISO 12151-3 - S - S

# Part Number	Flange inch	Hose I.D. inch	A		F inch	B	
			inch	mm		inch	mm
16A70-8-8	1/2	1/2	3.50	88,9	1-1/4	2.29	56,9

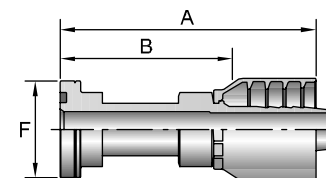

See Accessories Section for O-Rings and Flange Kits.

A

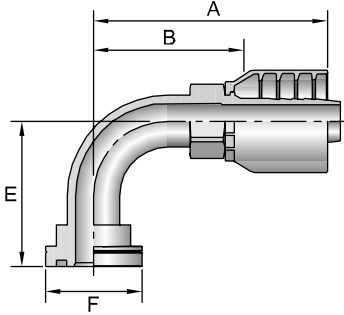

16N70

SAE Code 62 Flange Head - 90° Elbow

ISO 12151-3 - E90S - S (1 Piece: ISO 12151-3 - E90M - S)

#			A		E			B	
Part Number	Flange inch	Hose I.D. inch	inch	mm	inch	mm	inch	inch	mm
16N70-8-8	1/2	1/2	2.60	66	1.61	41	1-1/4	1.34	34



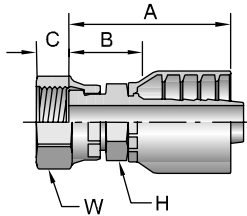

B



1JC70

Female Seal-Lok® - Swivel - Short

ISO 12151- 1 - SWSA

#			A		C				B	
Part Number	Thread inch	Hose I.D. inch	inch	mm	inch	mm	inch	inch	inch	mm
1JC70-6-6	3/8 11/16x16	3/8	1.94	49	0.34	9	11/16	13/16	1.04	26
1JC70-8-6	1/2 13/16x16	3/8	2.00	51	0.43	11	13/16	15/16	1.10	28
1JC70-8-8	1/2 13/16x16	1/2	2.22	56	0.43	11	13/16	15/16	1.01	26
1JC70-10-10	5/8 1x14	5/8	2.40	61	0.53	13	15/16	1-1/8	1.15	29



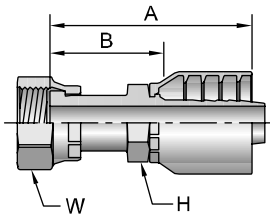

C



1JS70

Female Seal-Lok® - Swivel - Long

ISO 12151-1 - SWSB

#			A				B	
Part Number	Thread inch	Hose I.D. inch	inch	mm	inch	inch	inch	mm
1JS70-6-6	3/8 11/16x16	3/8	2.28	58	11/16	13/16	1.38	35
1JS70-8-8	1/2 13/16x16	1/2	2.65	67	13/16	15/16	1.44	37
1JS70-12-8	3/4 1-3/16x12	1/2	2.90	74	1-1/8	1-3/8	1.69	43
1JS70-12-10	3/4 1-3/16x12	5/8	3.10	79	1-1/8	1-3/8	1.85	47



D

1J770

Female Seal-Lok® - Swivel - 45° Elbow

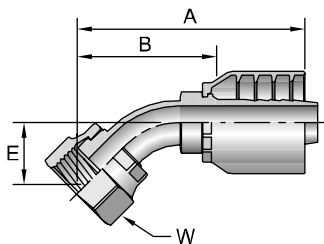
ISO 12151-1 - SWE45



#			A		E			B	
Part Number	Thread inch	Hose I.D. inch	inch	mm	inch	mm	inch	inch	mm
1J770-10-10	5/8 1x14	5/8	3.08	78	0.63	16	1-1/8	1.83	46

E

See Accessories Section for O-Rings and Flange Kits.

1J970

Female Seal-Lok® - Swivel - 90° Elbow - Short Drop
ISO 12151-1 - SWES90

# Part Number	Thread		Hose I.D. inch	A		E		W inch	B	
	inch	mm		inch	mm	inch	mm		inch	mm
1J970-8-8	1/2	13/16x16	1/2	2.59	66	1.14	29	15/16	1.38	35
1J970-12-8	3/4	1-3/16x12	1/2	3.21	82	1.88	48	1-3/8	2.00	51

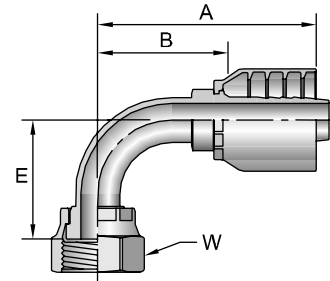

1J570

Female Seal-Lok® - Swivel - 90° Elbow - Medium Drop
ISO 12151-1 - SWEM90

# Part Number	Thread		Hose I.D. inch	A		E		W inch	B	
	inch	mm		inch	mm	inch	mm		inch	mm
1J570-10-10	5/8	1x14	5/8	2.88	73	1.85	47	1-1/8	1.63	41

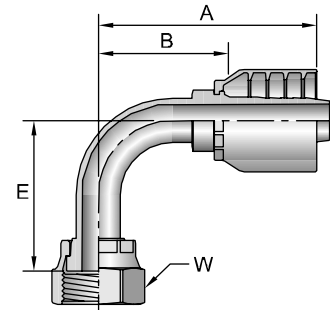

1J170

Female Seal-Lok® - Swivel - 90° Elbow - Long Drop
ISO 12151-1 - SWEL90

# Part Number	Thread		Hose I.D. inch	A		E		W inch	B	
	inch	mm		inch	mm	inch	mm		inch	mm
1J170-8-8	1/2	13/16x16	1/2	2.59	66	2.52	65	15/16	1.38	35
1J170-10-10	5/8	1x14	5/8	2.88	73	2.76	70	1-1/8	1.63	41

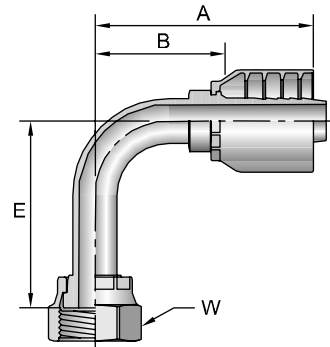



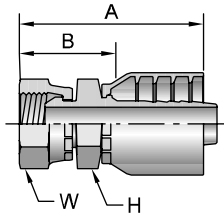

See Accessories Section for O-Rings and Flange Kits.

A



1GU70

Female BSP Parallel Pipe - Swivel - (60° Cone)

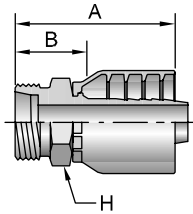

#			A				B	
Part Number	Thread	Hose I.D.	inch	mm	H	W	inch	mm
1GU70-6-6	3/8x19	3/8	2.45	62	22	NA	1.55	39
1GU70-8-8	1/2x14	1/2	2.82	72	27	NA	1.61	41

B



1FG70

Male French Gaz Series - Rigid - (24° Cone)

#			A				B	
Part Number	Thread	Hose I.D.	inch	mm	inch	mm	inch	mm
1FG70-21-10	21 M30x1,5	5/8	2.87	73	1.18	30	1.62	41

C

D

E

10C70

Female Metric S - Swivel - 45° Elbow - (24° Cone with O-Ring)
ISO 12151-2 - SWE45

# Part Number	Thread mm	Hose I.D. inch	A		E		W mm	B	
			inch	mm	inch	mm		inch	mm
10C70-12-6	12 M20x1,5	3/8	2.72	69	0.79	20	24	1.57	40
10C70-16-8	16 M24x1,5	1/2	3.27	83	0.94	24	30	1.89	48
10C70-20-10	20 M30x2	5/8	3.58	91	0.98	25	36	2.05	52

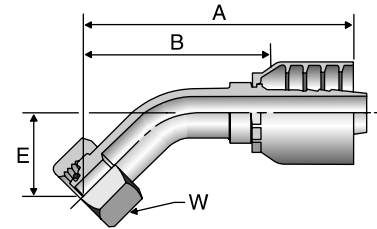

11C70

Female Metric S - Swivel - 90° Elbow - (24° Cone with O-Ring)
ISO 12151-2 - SWE

# Part Number	Thread mm	Hose I.D. inch	A		E		W mm	B	
			inch	mm	inch	mm		inch	mm
11C70-12-6	12 M20X1,5	3/8	2.64	67	1.46	37	24	1.50	38
11C70-20-10	20 M30X2	5/8	3.11	79	1.89	48	36	1.57	40

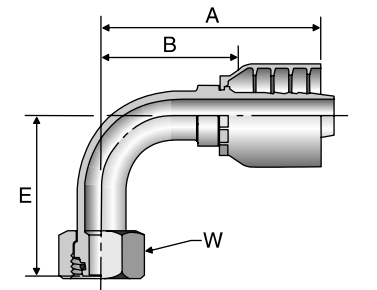

19270

Female BSP Parallel Pipe - Swivel - (60° Cone)
ISO 228-1

# Part Number	Thread inch	Hose I.D. inch	A		C		W mm	B	
			inch	mm	inch	mm		inch	mm
19270-6-6	3/8x19	3/8	1.93	49	0.28	7	22	0.79	20
19270-8-8	1/2x14	1/2	2.24	57	0.28	7	27	0.87	22
19270-10-10	5/8x14	5/8	2.24	57	0.35	9	30	0.83	21
19270-12-10	3/4x14	5/8	2.40	61	0.35	9	32	0.87	22

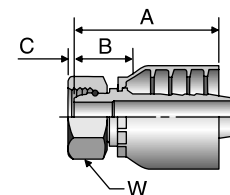

1B170

Female BSP Parallel pipe - Swivel- 45° Elbow - (60° Cone)
ISO 228-1

# Part Number	Thread inch	Hose I.D. inch	A		E		W mm	B	
			inch	mm	inch	mm		inch	mm
1B170-8-8	1/2x14	1/2	3.11	79	0.79	20	27	1.77	45

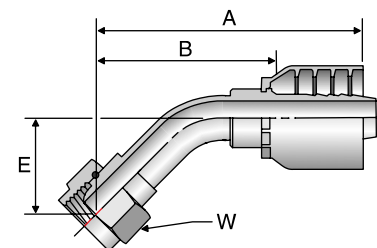

A

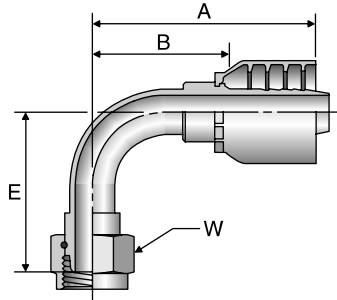

1B270

Female BSP Parallel Pipe - Swivel - 90° Elbow - (60° Cone)
ISO 228-1

# Part Number	Thread inch	Hose I.D. inch	A		E		W mm	B	
			inch	mm	inch	mm		inch	mm
1B270-8-8	1/2x14	1/2	2.76	70	1.54	39	27	1.38	35
1B270-10-10	5/8x14	5/8	3.07	78	1.81	46	30	1.61	41
1B270-12-10	3/4x14	5/8	3.19	81	1.65	42	32	1.61	41

B

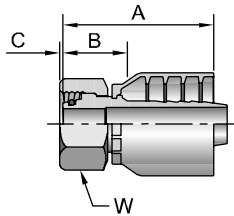

1C970

Female Metric S - Swivel - (24° Cone with O-Ring)

# Part Number	Thread		Hose I.D. inch	A		C		W mm	B	
	mm			inch	mm	inch	mm		inch	mm
1C970-12-6	12	M20x1,5	3/8	2.03	52	0.03	1	24	1.13	29
1C970-16-8	16	M24x1,5	1/2	2.31	59	0.09	2	30	1.10	28
1C970-20-10	20	M30x2	5/8	2.51	64	0.05	1	36	1.26	32

When measuring overall length to end of nut, B + C dimensions must be used to calculate cut-off allowance.

C

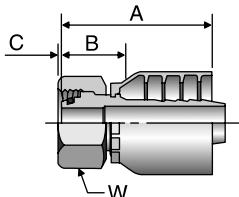

1CA70

Female Metric L - Swivel - (24° Cone with O-Ring)

ISO 12151-2 - SWS

# Part Number	Thread		Hose I.D. inch	A		C		W mm	B	
	mm			inch	mm	inch	mm		inch	mm
1CA70-12-6	12	M18x1,5	3/8	2.09	53	0.04	1	22	0.94	24
1CA70-15-8	15	M22x1,5	1/2	2.09	62	0.07	2	22	0.94	27
1CA70-18-10	18	M26x1,5	5/8	2.44	62	0.02	0.5	32	1.02	26

D

1CE70

Female Metric L - Swivel - 45° Elbow - (24° Cone with O-Ring)

ISO 12151-2 - SWE45

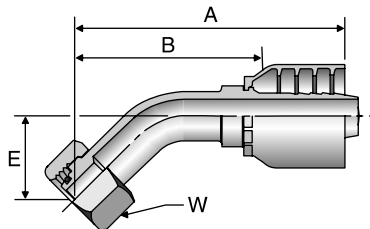

# Part Number	Thread		Hose I.D. inch	A		E		W mm	B	
	mm			inch	mm	inch	mm		inch	mm
1CE70-18-10	18	M26x1,5	5/8	3.58	91	0.98	25	32	2.05	52

E

1CF70

Female Metric L - Swivel - 90° Elbow - (24° Cone with O-Ring)

ISO 12151-2 - SWE

# Part Number	Thread mm	Hose I.D. inch	A		E		W mm	B	
			inch	mm	inch	mm		inch	mm
1CF70-15-8	15 M22x1,5	1/2	2.91	74	1.77	45	27	1.54	39
1CF70-18-10	18 M26x1,5	5/8	3.11	79	1.93	49	32	1.65	42

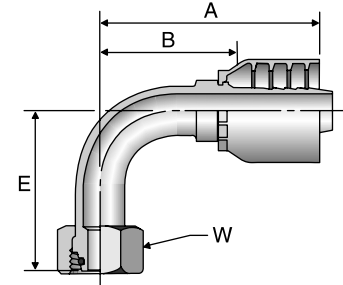

1D270

Male Metric S - Rigid - (24° Cone)

ISO 12151-2

# Part Number	Thread mm	Hose I.D. inch	A		H mm	B	
			inch	mm		inch	mm
1D270-16-8	16 M24x1,5	1/2	2.44	62	24	1.10	28
1D270-20-10	20 M30x2	5/8	2.95	75	30	1.26	32

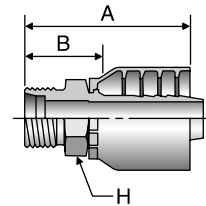

1D970

Male BSP Parallel Pipe - Rigid - (60° Cone)

ISO 228-1

# Part Number	Thread inch	Hose I.D. inch	A		H mm	B	
			inch	mm		inch	mm
1D970-8-8	1/2x14	1/2	2.44	62	27	1.10	28

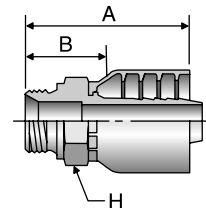

A

B

C

D

E











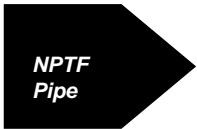
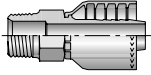

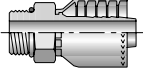

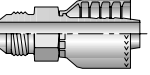
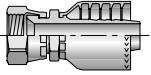
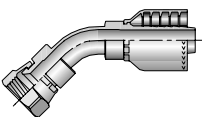
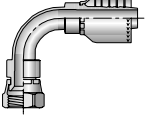
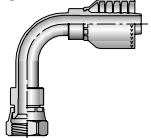
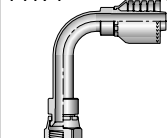

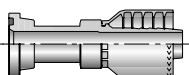
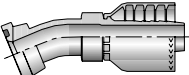
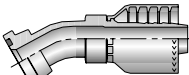
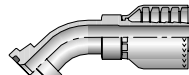
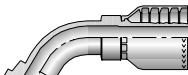
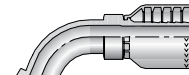
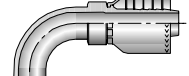
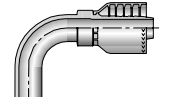
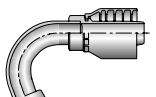

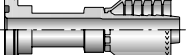
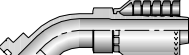
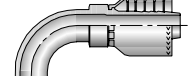
A

B

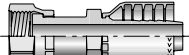
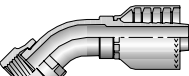
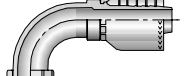
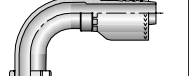
C

D

E

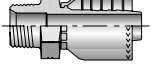
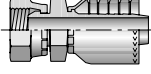
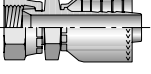
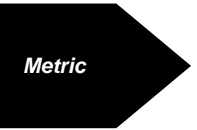
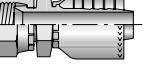
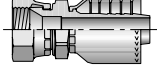
 NPTF Pipe	10171 B-72  <i>Male - Rigid</i>	 SAE	10571 B-72  <i>Male - Rigid</i>	 JIC	10371 B-72  <i>Male - Rigid</i>
10671 B-73  <i>Female - Swivel</i>	13771 B-73  <i>Female - Swivel 45° Elbow - Short</i>	13971 B-74  <i>Female - Swivel 90° Elbow - Short</i>	1L971 B-74  <i>Female - Swivel 90° Elbow - Medium</i>	14171 B-74  <i>Female - Swivel 90° Elbow - Long</i>	 Code 61 Flange
11571 B-75  <i>Flange</i>	11671 B-75  <i>22-1/2° Elbow</i>	12671 B-76  <i>30° Elbow</i>	11771 B-76  <i>45° Elbow</i>	12771 B-76  <i>60° Elbow</i>	11871 B-77  <i>67-1/2° Elbow</i>
11971 B-77  <i>90° Elbow</i>	18971 B-78  <i>90° Elbow-Long</i>	12U71 B-78  <i>110° Elbow</i>	 Code 62 Flange	16A71 B-78  <i>Flange</i>	16F71 B-78  <i>45° Elbow</i>
16N71 B-79  <i>90° Elbow</i>	 Seal-Lok® (O-Ring Face Seal)	1J071 B-79  <i>Male - Rigid</i>	1JC71 B-79  <i>Female - Swivel Short</i>	1JS71 B-80  <i>Female - Swivel Long</i>	1J771 B-80  <i>Female - Swivel 45° Elbow</i>
1J971 B-81  <i>Female - Swivel 90° Elbow - Short</i>	1J571 B-81  <i>Female - Swivel 90° Elbow - Medium</i>	1J171 B-81  <i>Female - Swivel 90° Elbow - Long</i>	 Metric "S"	1D271 B-82  <i>Male - Rigid</i>	1C971 B-82  <i>Female - Swivel</i>
 BSP	1UT71 B-82  <i>Male - Rigid</i>	1GU71 B-82  <i>Female - Swivel</i>	1FU71 B-83  <i>Female - Swivel</i>	 Metric	1MU71 B-83  <i>Female - Swivel</i>
1XU71 B-83  <i>Female - Swivel</i>					

A

B

C

D

E

10171 Male NPTF Pipe - Rigid

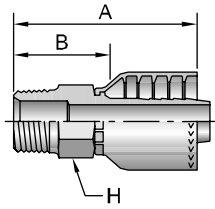

# Part Number	Thread		Hose I.D.		A		B	
	inch	inch	inch	mm	inch	inch	mm	
10171-6-6	3/8x18		3/8	2.36	60	3/4	1.47	37
10171-8-8	1/2x14		1/2	2.82	72	7/8	1.63	41
10171-12-8	3/4x14		1/2	2.67	68	1-1/16	1.47	37
10171-12-12	3/4x14		3/4	3.08	78	1-1/16	1.71	43
10171-16-12	1x11-1/2		3/4	3.08	78	1-3/8	1.72	44
10171-16-16	1x11-1/2		1	3.63	92	1-3/8	2.04	52
10171-20-16	1-1/4x11-1/2		1	3.49	89	1-11/16	1.90	48
10171-20-20	1-1/4x11-1/2		1-1/4	4.06	103	1-3/4	2.39	61
10171-24-20	1-1/2x11-1/2		1-1/4	3.77	96	2	2.10	53
10171-24-24	1-1/2x11-1/2		1-1/2	4.32	110	2	2.19	56
10171-32-32	2x11-1/2		2	4.72	118	2-1/2	2.52	64

10571 Male SAE Straight Thread with O-Ring - Rigid

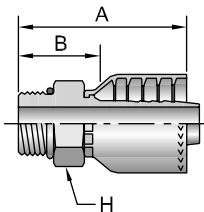

# Part Number	Thread		Hose I.D.		A		B	
	inch	inch	inch	inch	mm	inch	inch	mm
10571-8-8	1/2	3/4x16	1/2	2.44	62	7/8	1.25	32
10571-12-12	3/4	1-1/16x12	3/4	2.79	71	1-1/4	1.43	36
10571-16-16	1	1-5/16x12	1	3.42	87	1-1/2	1.77	45
10571-20-20	1-1/4	1-5/8x12	1-1/4	3.67	93	1-7/8	2.00	51

10371 Male JIC 37° - Rigid

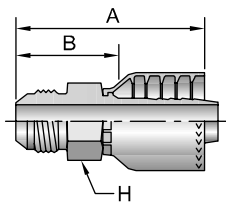

# Part Number	Thread		Hose I.D.		A		B	
	inch	inch	inch	inch	mm	inch	inch	mm
10371-6-6	3/8	9/16x18	3/8	2.44	62	3/4	1.55	39
10371-8-6	1/2	3/4x16	3/8	2.29	58	7/8	1.40	36
10371-8-8	1/2	3/4x16	1/2	2.66	68	7/8	1.41	36
10371-10-8	5/8	7/8x14	1/2	2.60	66	15/16	1.41	36
10371-10-10	5/8	7/8x14	5/8	2.93	74	15/16	1.69	43
10371-12-12	3/4	1-1/16x12	3/4	3.17	80	1-1/8	1.81	46
10371-14-12	7/8	1-3/16x12	3/4	3.09	78	1-1/4	1.73	44
10371-16-12	1	1-5/16x12	3/4	3.02	77	1-3/8	1.66	42
10371-16-16	1	1-5/16x12	1	3.68	93	1-3/8	2.03	52
10371-20-16	1-1/4	1-5/8x12	1	3.43	87	1-7/8	1.84	47
10371-20-20	1-1/4	1-5/8x12	1-1/4	3.94	100	1-7/8	2.27	58

10671

Female JIC 37° - Swivel

# Part Number	Thread		Hose I.D. inch	A		H inch	W inch	B		Additional Material Stainless Steel (C)
	inch	9/16x18		inch	mm			inch	mm	
10671-6-6	3/8	9/16x18	3/8	2.28	58	11/16	11/16	1.39	35	
10671-8-6	1/2	3/4x16	3/8	2.47	63	11/16	7/8	1.58	40	
10671-8-8	1/2	3/4x16	1/2	2.61	66	13/16	7/8	1.41	36	•
10671-10-8	5/8	7/8x14	1/2	2.84	72	7/8	1	1.64	42	
10671-10-10	5/8	7/8x14	5/8	2.83	72	15/16	1	1.58	40	
10671-10-12	5/8	7/8x14	3/4	2.92	74	1-1/16	1	1.54	39	
10671-12-8	3/4	1-1/16x12	1/2	2.75	70	1-1/16	1-1/4	1.58	40	
10671-12-10	3/4	1-1/16x12	5/8	3.00	76	1-1/16	1-1/4	1.75	44	
10671-12-12	3/4	1-1/16x12	3/4	2.96	75	1-1/16	1-1/4	1.60	41	•
10671-12-16	3/4	1-1/16x12	1	3.37	86	1-3/8	1-1/4	1.67	42	
10671-14-12	7/8	1-3/16x12	3/4	3.01	76	1-1/4	1-3/8	1.61	41	
10671-16-12	1	1-5/16x12	3/4	3.28	83	1-1/4	1-1/2	1.92	49	
10671-16-16	1	1-5/16x12	1	3.60	91	1-3/8	1-1/2	2.01	51	•
10671-20-16	1-1/4	1-5/8x12	1	3.80	97	1-5/8	2	2.21	56	
10671-20-20	1-1/4	1-5/8x12	1-1/4	3.92	100	1-7/8	2	2.25	57	•
10671-24-20	1-1/2	1-7/8x12	1-1/4	4.10	104	2-1/8	2-1/4	2.43	62	
10671-24-24	1-1/2	1-7/8x12	1-1/2	4.69	119	2-1/8	2-1/4	2.50	64	•
10671-32-32	2	2-1/2x12	2	5.39	137	2-1/2	2-7/8	3.19	81	

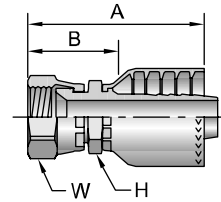

A

B

C

13771

Female JIC 37° - Swivel - 45° Elbow - Short Drop

# Part Number	Thread		Hose I.D. inch	A		E		W inch	B	
	inch	9/16x18		inch	mm	inch	mm		inch	mm
13771-6-6	3/8	9/16x18	3/8	2.34	59	0.43	11	11/16	1.44	37
13771-8-8	1/2	3/4x16	1/2	2.83	72	0.59	15	7/8	1.62	41
13771-10-8	5/8	7/8x14	1/2	2.93	74	0.63	16	1	1.72	44
13771-10-10	5/8	7/8x14	5/8	3.08	78	0.63	16	1	1.83	46
13771-12-12	3/4	1-1/16x12	3/4	3.64	92	0.83	21	1-1/4	2.26	57
13771-16-16	1	1-5/16x12	1	4.20	107	0.90	23	1-1/2	2.61	66
13771-20-20	1-1/4	1-5/8x12	1-1/4	5.22	133	1.69	43	2	3.53	90

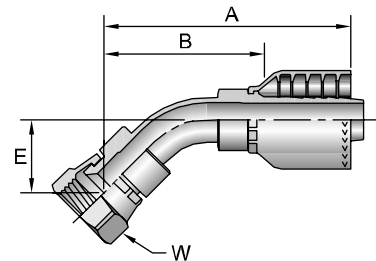

D

E

Stainless steel fittings must be assembled with Karrykrimp 2, PHastkrimp, Superkrimp or Parkrimp 2. See CrimpSource for more information.

13971

Female JIC 37° - Swivel - 90° Elbow - Short Drop

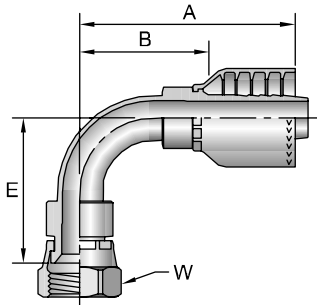

# Part Number	Thread		Hose I.D. inch	A		E		W inch	B	
	inch	9/16x18		inch	mm	inch	mm		inch	mm
13971-6-6	3/8	9/16x18	3/8	2.21	56	0.91	23	11/16	1.31	33
13971-8-8	1/2	3/4x16	1/2	2.62	67	1.14	29	7/8	1.41	36
13971-10-8	5/8	7/8x14	1/2	2.74	70	1.26	32	1	1.53	39
13971-10-10	5/8	7/8x14	5/8	2.88	73	1.26	32	1	1.63	41
13971-12-10	3/4	1-1/16x12	5/8	2.98	76	1.89	48	1-1/4	1.73	44
13971-12-12	3/4	1-1/16x12	3/4	3.50	89	1.89	48	1-1/4	2.11	54
13971-16-16	1	1-5/16x12	1	4.36	111	2.20	56	1-1/2	2.58	66
13971-20-20	1-1/4	1-5/8x12	1-1/4	4.78	121	3.33	85	2	3.11	79
13971-24-24	1-1/2	1-7/8x12	1-1/2	6.33	161	3.98	101	2-1/4	4.14	105

1L971

Female JIC 37° - Swivel - 90° Elbow - Medium Drop

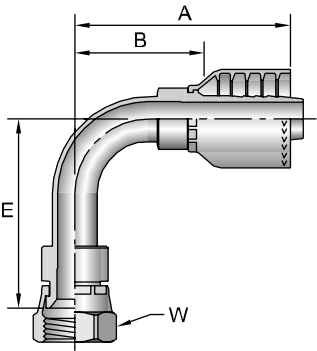

# Part Number	Thread		Hose I.D. inch	A		E		W inch	B	
	inch	7/8x14		inch	mm	inch	mm		inch	mm
1L971-10-8	5/8	7/8x14	1/2	3.24	82	1.75	44	1	2.04	52

14171

Female JIC 37° - Swivel - 90° Elbow - Long Drop

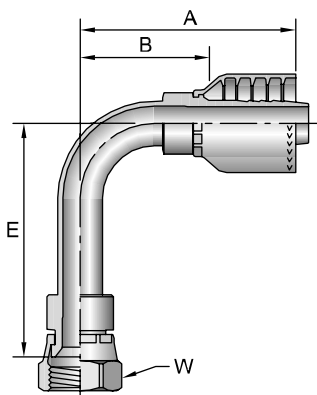

# Part Number	Thread		Hose I.D. inch	A		E		W inch	B	
	inch	9/16x18		inch	mm	inch	mm		inch	mm
14171-6-6	3/8	9/16x18	3/8	2.34	59	2.13	54	11/16	1.44	37
14171-8-8	1/2	3/4x16	1/2	2.58	66	2.52	64	7/8	1.37	35
14171-12-12	3/4	1-1/16x14	3/4	3.49	89	3.78	96	1-1/4	2.11	54
14171-16-16	1	1-5/16x12	1	4.36	111	4.32	110	1-1/2	2.58	66

11571

SAE Code 61 Flange Head
ISO 12151-3 - S - L

# Part Number	Flange inch	Hose I.D. inch	A		F inch	B	
			inch	mm		inch	mm
11571-8-8	1/2	1/2	3.48	88	1-3/16	2.27	58
11571-10-10	5/8	5/8	3.69	93,7	1-11/32	2.44	62,0
11571-12-8	3/4	1/2	2.46	62,5	1-1/2	1.26	32,0
11571-12-12	3/4	3/4	3.86	98	1-1/2	2.48	63
11571-16-12	1	3/4	2.74	70	1-3/4	1.36	35
11571-16-16	1	1	4.32	110	1-3/4	2.55	65
11571-20-12	1-1/4	3/4	3.90	99	2	2.54	65
11571-20-16	1-1/4	1	3.27	83	2	1.58	40
11571-20-20	1-1/4	1-1/4	4.70	119	2	3.01	76
11571-20-24	1-1/4	1-1/2	5.41	137	2	3.22	82
11571-24-16	1-1/2	1	3.41	86,6	2-3/8	1.63	41,4
11571-24-20	1-1/2	1-1/4	3.48	104	2-3/8	1.36	61
11571-24-24	1-1/2	1-1/2	5.46	139	2-3/8	3.27	83
11571-24-32	1-1/2	2	5.65	144	2-3/8	3.45	88
11571-32-20	2	1-1/4	4.29	109,0	2-13/16	2.60	66,0
11571-32-24	2	1-1/2	4.01	102	2-13/16	1.82	46
11571-32-32	2	2	5.65	144	2-13/16	3.45	88
11571-40-32	2-1/2	2	4.51	115	3-5/16	2.31	59

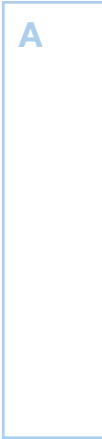
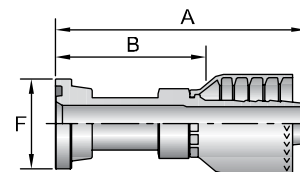

11671

SAE Code 61 Flange Head - 22-1/2° Elbow
ISO 12151-3 - E22M - L

# Part Number	Flange inch	Hose I.D. inch	A		E		F inch	B	
			inch	mm	inch	mm		inch	mm
11671-12-12	3/4	3/4	3.90	99	0.44	11	1-1/2	2.54	65
11671-16-12	1	3/4	3.89	99	0.44	11	1-3/4	2.53	64
11671-16-16	1	1	4.26	108	0.44	11	1-3/4	2.67	68
11671-20-16	1-1/4	1	4.36	111	0.47	12	2	2.77	70
11671-20-20	1-1/4	1-1/4	4.67	119	0.50	13	2	3.00	76
11671-24-20	1-1/2	1-1/4	4.68	119	0.53	13	2-3/8	3.01	76
11671-24-24	1-1/2	1-1/2	5.88	149	0.63	16	2-3/8	3.69	94
11671-32-32	2	2	7.37	187	0.88	22	2-13/16	5.22	133

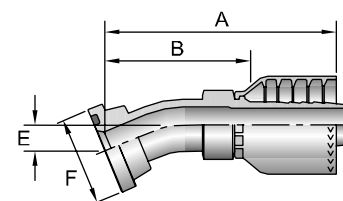

See Accessories Section for O-Rings and Flange Kits.

A

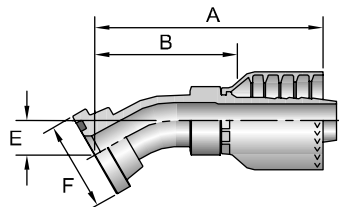

12671

SAE Code 61 Flange Head - 30° Elbow

ISO 12151-3 - E30S - L (1 Piece: ISO 12151-3 - E30M - L)

# Part Number	Flange inch	Hose I.D. inch	A		E		F inch	B	
			inch	mm	inch	mm		inch	mm
12671-12-12	3/4	3/4	3.90	99	0.59	15	1-1/2	2.52	64
12671-16-16	1	1	4.46	113	0.62	16	1-3/4	2.68	68
12671-20-16	1-1/4	1	4.46	113	0.62	16	2	2.68	68
12671-20-20	1-1/4	1-1/4	4.87	124	0.72	18	2	3.18	81
12671-24-24	1-1/2	1-1/2	6.01	153	0.88	22	2-3/8	3.82	97
12671-32-24	2	1-1/2	6.01	153	0.88	22	2-13/16	3.82	97
12671-32-32	2	2	7.60	193	1.25	32	2-13/16	5.40	137

B

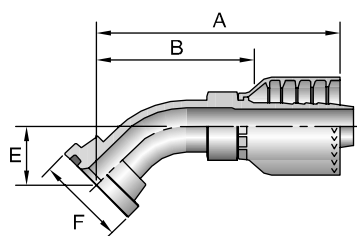

11771

SAE Code 61 Flange Head - 45° Elbow

ISO 12151-3 - E45S - L (1 Piece: ISO 12151-3 - E45M - L)

# Part Number	Flange inch	Hose I.D. inch	A		E		F inch	B	
			inch	mm	inch	mm		inch	mm
11771-10-10	5/8	5/8	4.54	115	0.94	24	1-11/32	3.29	84
11771-12-8	3/4	1/2	3.27	83	0.84	21	1-1/2	2.07	53
11771-12-10	3/4	5/8	3.94	100	0.76	19	1-1/2	2.70	69
11771-12-12	3/4	3/4	3.85	98	1.02	26	1-1/2	2.47	63
11771-16-12	1	3/4	3.85	98	1.02	26	1-3/4	2.47	63
11771-16-16	1	1	4.84	123	1.26	32	1-3/4	3.06	78
11771-20-16	1-1/4	1	4.84	123	1.02	26	2	3.06	78
11771-20-20	1-1/4	1-1/4	5.61	142	1.50	38	2	3.92	100
11771-20-24	1-1/4	1-1/2	6.22	158	1.12	28	2	4.03	102
11771-24-20	1-1/2	1-1/4	5.55	141	1.50	38	2-3/8	3.86	98
11771-24-24	1-1/2	1-1/2	6.22	158	1.41	36	2-3/8	4.03	102
11771-32-24	2	1-1/2	6.19	157	1.41	36	2-13/16	4.00	102
11771-32-32	2	2	7.94	202	2.03	52	2-13/16	5.74	146
11771-40-32	2-1/2	2	7.83	199	2.03	52	3-5/16	5.62	143

C

D

E

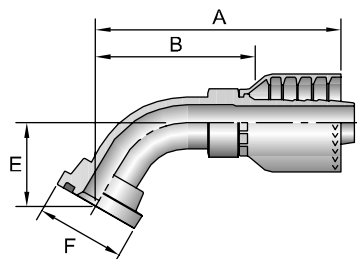

12771

SAE Code 61 Flange Head - 60° Elbow

ISO 12151-3 - E60S - L (1 Piece: ISO 12151-3 - E60M - L)

# Part Number	Flange inch	Hose I.D. inch	A		E		F inch	B	
			inch	mm	inch	mm		inch	mm
12771-12-12	3/4	3/4	4.16	106	1.43	36	1-1/2	2.78	71
12771-16-12	1	3/4	4.15	105	1.39	35	1-3/4	2.77	70
12771-16-16	1	1	4.74	120	1.49	38	1-3/4	3.36	85
12771-20-20	1-1/4	1-1/4	5.10	130	1.69	43	2	3.41	87
12771-24-20	1-1/2	1-1/4	5.12	130	1.70	43	2-3/8	3.43	87
12771-24-24	1-1/2	1-1/2	6.25	159	2.03	52	2-3/8	4.06	103
12771-32-32	2	2	7.93	201	2.88	73	2-13/16	5.73	146

See Accessories Section for O-Rings and Flange Kits.

11871

SAE Code 61 Flange Head - 67-1/2° Elbow

ISO 12151-3 - E67S - L (1 Piece: ISO 12151-3 - E67M - L)

# Part Number	Flange inch	Hose I.D. inch	A		E		F inch	B	
			inch	mm	inch	mm		inch	mm
11871-12-12	3/4	3/4	4.12	105	1.62	41	1-1/2	2.74	70
11871-16-12	1	3/4	4.11	104	1.59	40	1-3/4	2.73	69
11871-16-16	1	1	4.76	121	1.75	44	1-3/4	2.98	76
11871-20-20	1-1/4	1-1/4	5.08	129	1.94	49	2	3.39	86
11871-24-20	1-1/2	1-1/4	5.07	129	1.95	50	2-3/8	3.38	86
11871-24-24	1-1/2	1-1/2	6.20	157	2.31	59	2-3/8	4.01	102
11871-32-24	2	1-1/2	6.20	157	2.31	59	2-13/16	4.01	102
11871-32-32	2	2	7.89	200	3.31	84	2-13/16	5.69	145

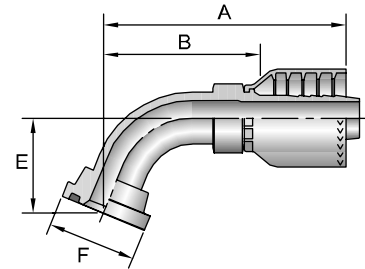

11971

SAE Code 61 Flange Head - 90° Elbow

ISO 12151-3 - E90S - L (1 Piece: ISO 12151-3 - E90M - L)

# Part Number	Flange inch	Hose I.D. inch	A		E		F inch	B	
			inch	mm	inch	mm		inch	mm
11971-8-8	1/2	1/2	2.93	74	1.6	41	1-3/16	1.72	44
11971-10-10	5/8	5/8	3.62	92	2.10	53	1-11/32	2.37	60
11971-12-8	3/4	1/2	2.93	74	1.66	42	1-1/2	1.72	44
11971-12-10	3/4	5/8	3.62	92	2.10	53	1-1/2	2.37	60
11971-12-12	3/4	3/4	3.48	88	2.28	58	1-1/2	2.10	53
11971-16-12	1	3/4	3.52	89	2.28	58	1-3/4	2.14	54
11971-16-16	1	1	4.36	111	2.76	70	1-3/4	2.58	66
11971-16-20	1	1-1/4	4.53	115	2.39	61	1-3/4	2.75	70
11971-20-12	1-1/4	3/4	3.81	97	2.13	54	2	2.45	62
11971-20-16	1-1/4	1	4.33	110	2.76	70	2	2.55	65
11971-20-20	1-1/4	1-1/4	5.12	130	3.54	90	2	3.43	87
11971-20-24	1-1/4	1-1/2	6.33	161	3.00	76	2	4.14	105
11971-24-16	1-1/2	1	4.53	115	2.39	61	2-3/8	2.75	70
11971-24-20	1-1/2	1-1/4	5.09	129	3.54	90	2-3/8	3.40	86
11971-24-24	1-1/2	1-1/2	6.34	161	4.09	104	2-3/8	4.15	105
11971-32-24	2	1-1/2	6.98	148	4.09	79	2-13/16	4.36	93
11971-32-32	2	2	7.75	197	5.43	138	2-13/16	5.55	141
11971-40-32	2-1/2	2	7.43	189	4.5	114	3-5/16	5.23	133

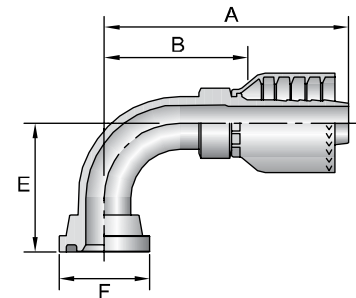

See Accessories Section for O-Rings and Flange Kits.

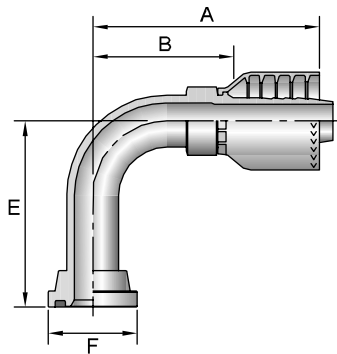

18971

SAE Code 61 Flange Head - 90° Elbow - Long Drop

#	Flange	Hose I.D.	A		E		F	B	
Part Number	inch	inch	inch	mm	inch	mm	inch	inch	mm
18971-12-12	3/4	3/4	3.49	89	3.03	77	1-1/2	2.11	54
18971-16-16	1	1	4.52	115	4.60	117	1-3/4	2.74	70
18971-20-16	1-1/4	1	4.53	115	4.60	117	2	2.75	70

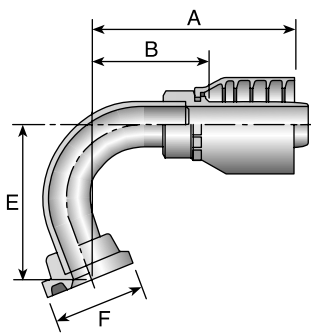

12U71

SAE Code 61 Flange Head - 110° Elbow

#	Flange	Hose I.D.	A		E		F	B	
Part Number	inch	inch	inch	mm	inch	mm	inch	inch	mm
12U71-16-16	1	1	4.49	114	3.69	94	1-3/4	2.71	69

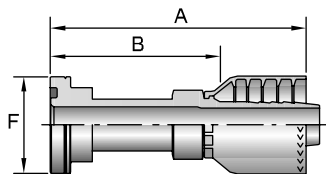

16A71

SAE Code 62 Flange Head ISO 12151-3 - S - S

#	Flange	Hose I.D.	A		F	B	
Part Number	inch	inch	inch	mm	inch	inch	mm
16A71-12-12	3/4	3/4	4.31	109	1-5/8	2.93	74
16A71-16-12	1	3/4	3.10	78,7	1-7/8	1.72	43,7
16A71-16-16	1	1	4.89	124	1-7/8	3.11	79
16A71-20-16	1-1/4	1	3.69	93,7	2-1/8	1.91	48,5
16A71-20-20	1-1/4	1-1/4	5.01	127,3	2-1/8	3.32	84,3
16A71-24-24	1-1/2	1-1/2	6.34	161,0	2-1/2	4.15	105,4
16A71-32-32	2	2	7.16	182	3-1/8	4.96	126

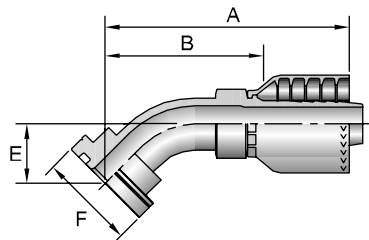

16F71

SAE Code 62 Flange Head - 45° Elbow ISO 12151-3 - E45S - L (1 Piece: ISO 12151-3 - E45M - S)

#	Flange	Hose I.D.	A		E		F	B	
Part Number	inch	inch	inch	mm	inch	mm	inch	inch	mm
16F71-12-12	3/4	3/4	3.82	97	1.03	26	1-5/8	2.44	62
16F71-16-16	1	1	4.74	120,3	1.26	32	1-7/8	2.96	75,2
16F71-20-16	1-1/4	1	4.61	117	1.06	27	2-1/8	3.02	77
16F71-20-20	1-1/4	1-1/4	5.07	129	1.19	30	2-1/8	3.38	86
16F71-24-24	1-1/2	1-1/2	6.21	158	1.44	37	2-1/2	4.02	102
16F71-32-32	2	2	7.87	200	2.05	52	3-1/8	5.67	144

See Accessories Section for O-Rings and Flange Kits.

16N71

SAE Code 62 Flange Head - 90° Elbow

ISO 12151-3 - E90S - L (1 Piece: ISO 12151-3 - E90M - S)

# Part Number	Flange inch	Hose I.D. inch	A		E		F		B	
			inch	mm	inch	mm	inch	inch	mm	
16N71-12-12	3/4	3/4	3.51	89	2.28	58	1-5/8	2.13	54	
16N71-16-12	1	3/4	3.49	89	2.29	58	1-7/8	2.11	54	
16N71-16-16	1	1	4.36	111	2.76	70	1-7/8	2.58	66	
16N71-20-16	1-1/4	1	4.36	111	2.76	70	2-1/8	2.58	66	
16N71-20-20	1-1/4	1-1/4	5.09	129	3.54	90	2-1/8	3.40	86	
16N71-24-24	1-1/2	1-1/2	5.85	149	3.12	79	2-1/2	3.66	93	
16N71-32-32	2	2	7.73	196	4.50	114	3-1/8	5.53	140	

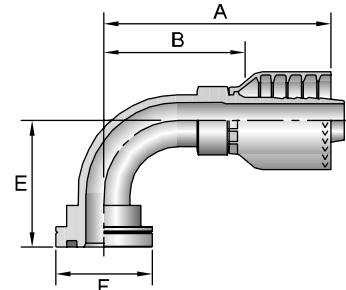

⚠ Refer to Pressure Rating of Hose End Connections chart on page E-43.

1J071

Male Seal-Lok® - Rigid - (with O-Ring)

ISO 12151-1 - S

# Part Number	Thread inch		Hose I.D. inch	A		H inch	B	
	inch	inch		inch	mm		inch	mm
1J071-8-8	1/2	13/16x16	1/2	2.40	61	7/8	1.20	30
1J071-10-8	5/8	1x14	1/2	2.61	66	1-1/16	1.41	36
1J071-10-10	5/8	1x14	5/8	2.69	68	1-1/16	1.44	37
1J071-12-10	3/4	1-3/16x12	5/8	2.79	71	1-1/4	1.55	39
1J071-12-12	3/4	1-3/16x12	3/4	2.87	73	1-1/4	1.51	38
1J071-16-12	1	1-7/16x12	3/4	2.91	74	1-1/2	1.53	39
1J071-16-16	1	1-7/16x12	1	3.27	83	1-1/2	1.68	43
1J071-20-20	1-1/4	1-11/16x12	1-1/4	3.31	84	1-3/4	1.64	42
1J071-24-24	1-1/2	2x12	1-1/2	4.02	102	2-1/8	1.83	46

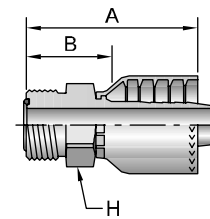

1JC71

Female Seal-Lok® - Swivel - Short

ISO 12151-1 - SWSA

# Part Number	Thread inch		Hose I.D. inch	A		C inch	H		W		B	
	inch	inch		inch	mm		inch	inch	inch	mm		
1JC71-8-8	1/2	13/16x16	1/2	2.22	56	0.43	11	13/16	15/16	1.01	26	
1JC71-10-10	5/8	1x14	5/8	2.40	61	0.48	12	15/16	1-1/8	1.15	29	
1JC71-12-12	3/4	1-3/16x12	3/4	2.68	68	0.55	14	1-1/8	1-3/8	1.30	33	
1JC71-16-16	1	1-7/16x12	1	3.22	82	0.56	14	1-3/8	1-5/8	1.44	37	
1JC71-20-16	1-1/4	1-11/16x12	1	3.16	80	0.59	15	1-5/8	1-7/8	1.38	35	

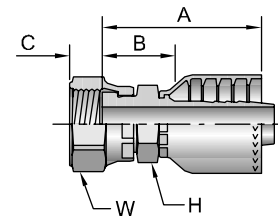

When measuring overall length to end of nut, B+C dimensions must be used to calculate cut-off allowance.

See Accessories Section for O-Rings and Flange Kits.

1JS71

Female Seal-Lok® - Swivel - Long

ISO 12151-1 - SWSB

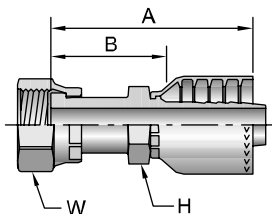

# Part Number	Thread		Hose I.D. inch	A		H inch	W inch	B	
	inch	mm		inch	mm			inch	mm
1JS71-6-6	3/8	11/16x16	3/8	2.80	58	11/16	13/16	1.38	35
1JS71-6-8	3/8	11/16x16	1/2	2.50	64	13/16	13/16	1.29	33
1JS71-8-8	1/2	13/16x16	1/2	2.64	67	13/16	15/16	1.44	37
1JS71-10-8	5/8	1x14	1/2	2.89	23	13/16	1-1/8	1.69	43
1JS71-10-10	5/8	1x14	5/8	3.00	76	15/16	1-1/8	1.75	44
1JS71-10-12	5/8	1x14	3/4	3.08	78	1-1/16	1-1/8	1.70	43
1JS71-12-10	3/4	1-3/16x12	5/8	3.10	79	1-1/8	1-3/8	1.85	47
1JS71-12-12	3/4	1-3/16x12	3/4	3.31	84	1-1/16	1-3/8	1.93	49
1JS71-16-12	1	1-7/16x12	3/4	3.37	86	1-5/16	1-5/8	1.99	51
1JS71-16-16	1	1-7/16x12	1	3.70	94	1-5/16	1-5/8	1.92	49
1JS71-20-16	1-1/4	1-11/16x12	1	3.64	92	1-3/4	1-7/8	1.94	49
1JS71-20-20	1-1/4	1-11/16x12	1-1/4	3.77	96	1-3/4	1-7/8	2.08	53
1JS71-24-24	1-1/2	2x12	1-1/2	4.51	114,6	2	2-1/4	2.32	58,9

1J771

Female Seal-Lok® - Swivel - 45° Elbow

ISO 12151-1 - SWE45

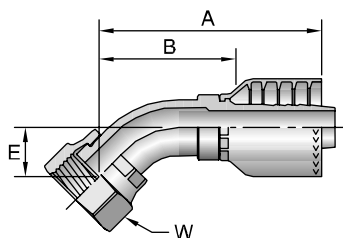

# Part Number	Thread		Hose I.D. inch	A		E		W inch	B	
	inch	mm		inch	mm	inch	mm		inch	mm
1J771-6-6	3/8	11/16x16	3/8	2.34	59	0.43	11	13/16	1.44	37
1J771-8-8	1/2	13/16x16	1/2	2.83	72	0.59	15	15/16	1.62	41
1J771-10-8	5/8	1x14	1/2	2.93	74	0.63	16	1-1/8	1.72	44
1J771-10-10	5/8	1x14	5/8	3.08	78	0.63	16	1-1/8	1.83	46
1J771-12-12	3/4	1-3/16x12	3/4	3.63	92	0.83	21	1-3/8	2.25	57
1J771-16-16	1	1-7/16x12	1	4.46	113	0.94	24	1-5/8	2.68	68
1J771-20-20	1-1/4	1-11/16x12	1-1/4	4.75	121	1.00	25	1-7/8	3.08	78
1J771-24-24	1-1/2	2x12	1-1/2	5.43	138	1.07	27	2-1/4	3.23	82

See Accessories Section for O-Rings.

1J971

Female Seal-Lok® - Swivel - 90° Elbow - Short Drop
ISO 12151-1 - SWES90

# Part Number	Thread		Hose I.D. inch	A		E		W inch	B	
	inch			inch	mm	inch	mm		inch	mm
1J971-6-6	3/8	11/16x16	3/8	2.21	56	0.91	23	13/16	1.31	33
1J971-8-8	1/2	13/16x16	1/2	2.59	66	1.14	29	15/16	1.38	35
1J971-10-8	5/8	1x14	1/2	2.74	70	1.26	32	1-1/8	1.53	39
1J971-10-10	5/8	1x14	5/8	2.88	73	1.26	32	1-1/8	1.63	41
1J971-10-12	5/8	1x14	3/4	3.07	78	1.27	32	1-1/8	1.70	43
1J971-12-10	3/4	1-3/16x12	5/8	3.40	86	1.89	48	1-3/8	2.15	55
1J971-12-12	3/4	1-3/16x12	3/4	3.49	89	1.89	48	1-3/8	2.11	54
1J971-16-16	1	1-7/16x12	1	4.36	111	2.20	56	1-5/8	2.58	66
1J971-20-20	1-1/4	1-11/16x12	1-1/4	4.86	123	2.51	64	1-7/8	3.19	81
1J971-24-24	1-1/2	2x12	1-1/2	6.22	158	2.68	68	2-1/4	4.03	102

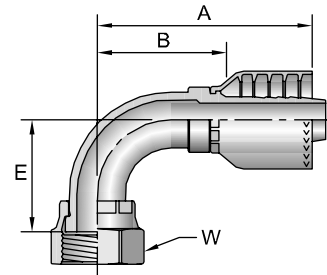

1J571

Female Seal-Lok® - Swivel - 90° Elbow - Medium Drop
ISO 12151-1 - SWEM90

# Part Number	Thread		Hose I.D. inch	A		E		W inch	B	
	inch			inch	mm	inch	mm		inch	mm
1J571-8-8	1/2	13/16x16	1/2	2.59	66	1.61	41	15/16	1.38	35
1J571-10-10	5/8	1x14	5/8	2.88	73	1.85	47	1-1/8	1.63	41
1J571-12-12	3/4	1-3/16x12	3/4	3.49	89	2.28	58	1-3/8	2.11	54

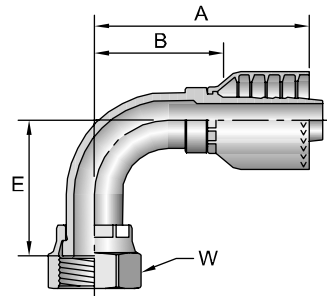

1J171

Female Seal-Lok® - Swivel - 90° Elbow - Long Drop
ISO 12151-1 - SWEL90

# Part Number	Thread		Hose I.D. inch	A		E		W inch	B	
	inch			inch	mm	inch	mm		inch	mm
1J171-6-6	3/8	11/16x16	3/8	2.39	61	2.13	54	13/16	1.49	38
1J171-8-8	1/2	13/16x16	1/2	2.59	66	2.52	64	15/16	1.38	35
1J171-10-10	5/8	1x14	5/8	2.88	73	2.76	70	1-1/8	1.63	41
1J171-12-12	3/4	1-3/16x12	3/4	3.49	89	3.78	96	1-3/8	2.11	54
1J171-16-12	1	1-7/16x12	3/4	4.07	103	4.50	114	1-5/8	2.69	68
1J171-16-16	1	1-7/16x12	1	4.36	111	4.49	114	1-5/8	2.58	66
1J171-20-20	1-1/4	1-11/16x12	1-1/4	4.88	124	5.09	129	1-7/8	3.19	81
1J171-24-24	1-1/2	2x12	1-1/2	5.83	148	5.54	141	2-1/4	3.64	92

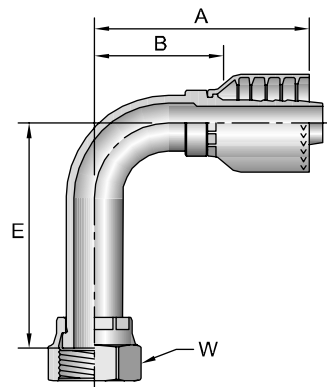

See Accessories Section for O-Rings.

A

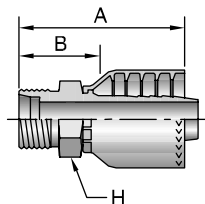

1D271 Male Metric S - Rigid - (24° Cone) ISO 12151-2

# Part Number	Thread		Hose I.D. inch	A		H mm	B	
	mm	mm		inch	mm		inch	mm
1D271-25-12	25	M36x2	3/4	2.90	74	36	1.52	39
1D271-30-16	30	M42x2	1	3.45	88	46	1.67	42

B

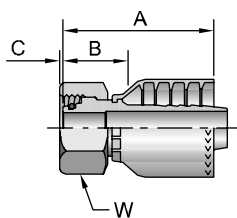

1C971 Female Metric S - Swivel - (24° Cone with O-Ring) ISO 12151-2 - SWS - S

# Part Number	Thread		Hose I.D. inch	A		C		W mm	B	
	mm	mm		inch	mm	inch	mm		inch	mm
1C971-12-6	12	M20x1,5	3/8	2.05	52	0.03	1	24	0.87	22
1C971-16-8	16	M24x1,5	1/2	2.33	59	0.09	2	30	0.94	24
1C971-20-10	20	M30x2	5/8	2.60	66	0.05	1	36	1.06	27
1C971-25-12	25	M36x2	3/4	2.68	68	0.10	3	46	1.10	28
1C971-30-16	30	M42x2	1	3.07	78	0.19	5	50	1.30	33
1C971-38-20	38	M52x2	1-1/4	3.15	80	0.23	6	60	1.30	33

When measuring overall length to end of nut, B+C dimensions must be used to calculate cut-off allowance.

C

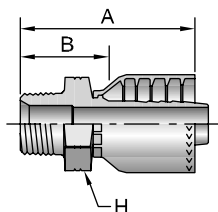

1UT71 Male BSP Taper Pipe - Rigid - (60° Cone)

# Part Number	Hose I.D. inch	A		H mm	B	
		inch	mm		inch	mm
1UT71-8-8	1/2	2.66	68	27	1.46	37
1UT71-12-12	3/4	2.95	75	36	1.59	40

D

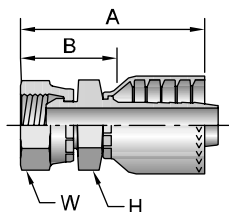

1GU71 Female BSP Parallel Pipe - Swivel - (60° Cone)

# Part Number	Thread		Hose I.D. inch	A		H mm	W mm	B	
	inch	mm		inch	mm			inch	mm
1GU71-6-6	3/8	3/8x19	3/8	2.45	62	22	22	1.55	39
1GU71-8-8	1/2	1/2x14	1/2	2.81	71	27	27	1.61	41
1GU71-12-12	3/4	3/4x14	3/4	3.24	82	36	36	1.86	47
1GU71-16-16	1	1x11	1	3.82	97	41	41	2.04	52
1GU71-20-20	1-1/4	1-1/4x11	1-1/4	4.07	103	50	50	2.38	60
1GU71-24-24	1-1/2	1-1/2x11	1-1/2	4.81	122	60	60	2.62	67
1GU71-32-32	2	2x11	2	5.17	131	70	70	2.97	75

E

Metric S: Mates with EO "S" Series Fittings.

^^ Must be assembled with Die Part No. 83C-D20H in a Superkrimp or Parkrimp 2.

See Accessories Section for O-Rings and Flange Kits.

1FU71

Female BSP Parallel Pipe - Swivel - (30° Flare)

# Part Number	Thread inch	Hose I.D. inch	A		H mm	W mm	B	
			inch	mm			inch	mm
1FU71-6-6	3/8x19	3/8	2.39	61	24	22	1.50	38
1FU71-8-8	1/2x14	1/2	2.71	69	27	27	1.51	38
1FU71-12-12	3/4x14	3/4	3.10	79	36	36	1.74	44
1FU71-16-16	1x11	1	3.52	89	41	41	1.93	49
1FU71-20-20	1-1/4x11	1-1/4	3.87	98	50	50	2.20	56
1FU71-24-24	1-1/2x11	1-1/2	4.66	118	60	60	2.53	64

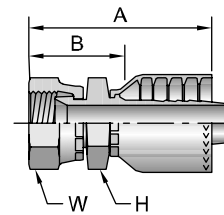

1MU71

Female Metric - Swivel - (30° Flare)

# Part Number	Thread inch	Hose I.D. inch	A		H mm	W mm	B	
			inch	mm			inch	mm
1MU71-6-6	M18x1,5	3/8	2.45	62	24	24	1.56	40
1MU71-8-8	M22x1,5	1/2	2.83	72	27	27	1.45	37

Japanese Fittings - Female Swivel 30° Flare with Metric Threads. All 30° flared fitting sizes are available by combining 1MU71 fittings in sizes up to 1/2 with 1XU71 fittings in sizes 5/8 inch and larger.

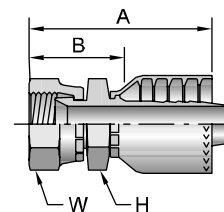

1XU71

Female Metric - Swivel - (30° Flare)

# Part Number	Thread inch	Hose I.D. inch	A		H mm	W mm	B	
			inch	mm			inch	mm
1XU71-10-10	M24x1,5	5/8	3.16	80	30	32	1.91	49
1XU71-12-12	M30x1,5	3/4	3.40	86	32	36	2.02	51
1XU71-16-16	M33x1,5	1	4.11	104	36	41	2.33	59
1XU71-20-20	M36x1,5	1-1/2	4.19	106	46	46	2.50	64
1XU71-24-24	M42x1,5	1-1/2	5.00	127	50	55	2.80	71

Japanese Fittings - Female Swivel 30° Flare with Metric Threads. All 30° flared fitting sizes are available by combining 1MU71 fittings in sizes up to 1/2 with 1XU71 fittings in sizes 5/8 inch and larger.

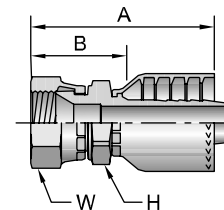











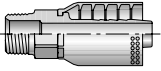

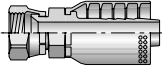
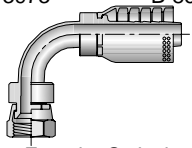

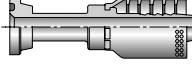
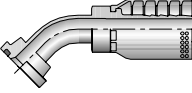
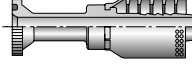
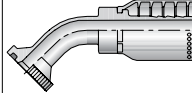
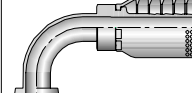
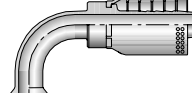

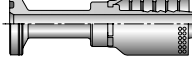
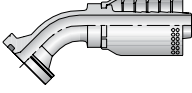
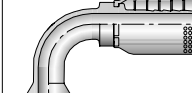

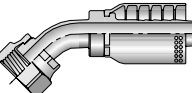
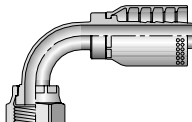

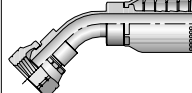
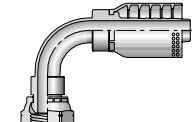
A

B

C

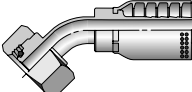
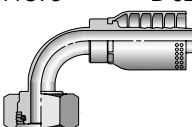
D

E

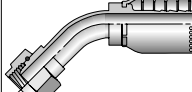
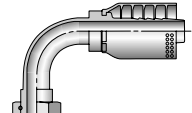
 NPTF Pipe	10173 B-86  <i>Male - Rigid</i>	 JIC 37°	10673 B-86  <i>Female - Swivel</i>	13973 B-86  <i>Female - Swivel 90° Elbow - Short</i>	 Code 61 Flange
11573 B-86  <i>Flange</i>	11773 B-87  <i>45° Elbow</i>	14A73 B-87  <i>Flange (5000 psi)</i>	14F73 B-87  <i>45° Elbow (5000 psi)</i>	11973 B-87  <i>90° Elbow</i>	14N73 B-88  <i>90° Elbow (5000 psi)</i>
 Code 62 Flange	16A73 B-88  <i>Flange</i>	16F73 B-88  <i>45° Elbow</i>	16N73 B-88  <i>90° Elbow</i>	 Seal-Lok® (O-Ring Face Seal)	1JS73 B-89  <i>Female - Swivel Long</i>
1J773 B-89  <i>Female - Swivel 45° Elbow</i>	1J973 B-89  <i>Female - Swivel 90° Elbow - Short</i>	 BSP 60° Cone	1GU73 B-90  <i>Female - Swivel</i>	1G173 B-90  <i>Female - Swivel 45° Elbow</i>	1G273 B-90  <i>Female - Swivel 90° Elbow</i>
 DIN "L" Series	1CA73 B-91  <i>Female Metric L - Swivel</i>	 DIN "S" Series	1D273 B-91  <i>Male Metric S - Rigid</i>	1C973 B-91  <i>Female Metric S - Swivel</i>	10C73 B-91  <i>Female Metric S - Swivel</i>
11C73 B-92  <i>Female Metric S - Swivel</i>	 BSP 60° Cone	1D973 B-92  <i>Male BSP - Parallel Pipe - Rigid</i>	19273 B-92  <i>Female BSP - Parallel Pipe - Swivel</i>	1B173 B-93  <i>Female BSP - Parallel Pipe - Swivel</i>	1B273 B-93  <i>Female BSP - Parallel Pipe - Swivel</i>

A

B

C

D

E

A

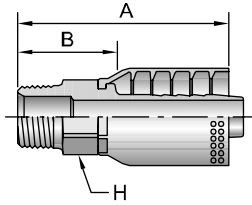

10173 Male NPTF Pipe - Rigid

# Part Number	Thread inch	Hose I.D. inch	A		H inch	B	
			inch	mm		inch	mm
10173-12-12	3/4x14	3/4	3.56	90	1-1/8	1.75	44
10173-16-16	1x11-1/2	1	3.94	100	1-3/8	2.00	51
10173-20-20	1-1/4x11-1/2	1-1/4	4.92	125	1-3/4	2.43	62
10173-24-24	1-1/2x11-1/2	1-1/2	4.88	124	2	2.57	65
10173-32-32	2x11-1/2	2	5.57	141	2-1/2	2.87	73

Note: All sizes of 10173 fittings are rated at 5,000 psi working pressure.

B

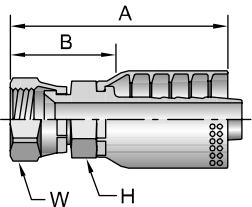

10673 Female JIC 37° - Swivel

# Part Number	Thread inch		Hose I.D. inch	A		H inch	W inch	B	
	inch	mm		inch	mm			inch	mm
10673-12-12	3/4	1-1/16x12	3/4	3.66	93	1-1/8	1-1/4	1.85	47
10673-16-12	1	1-5/16x12	3/4	3.90	99	1-3/8	1-1/2	2.09	53
10673-16-16	1	1-5/16x12	1	4.03	102	1-3/8	1-1/2	2.09	53
10673-20-20	1-1/4	1-5/8x12	1-1/4	4.93	125	1-3/4	2	2.44	62
10673-24-24	1-1/2	1-7/8x12	1-1/2	5.04	128	2	2-1/4	2.73	69
10673-32-32	2	2-1/2x12	2	5.91	150	2-1/2	2-7/8	3.21	82

Note: All sizes of 10673 fittings are rated at 5,000 psi working pressure.

C

13973 Female JIC 37° - Swivel - 90° Elbow - Short Drop

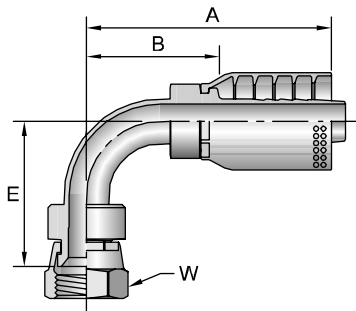

# Part Number	Thread inch	Hose I.D. inch	A		E		W inch	B	
			inch	mm	inch	mm		inch	mm
13973-12-12	3/4	1-1/16x12	3/4	4.12	105	2.44	62	1-1/4	2.31
13973-16-16	1	1-5/16x12	1	4.71	120	2.93	74	1-1/2	2.77

Note: All sizes of 13973 fittings are rated at 5,000 psi working pressure.

D

11573 SAE Code 61 Flange Head ISO 12151-3 - S - L

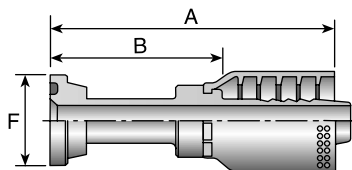

# Part Number	Flange inch	Hose I.D. inch	A		F inch	B	
			inch	mm		inch	mm
11573-12-12	3/4	3/4	4.34	110.2	1-1/2	2.53	64.3
11573-16-16	1	1	4.59	117	1-3/4	2.65	67

See Accessories Section for O-Rings and Flange Kits.

11773

SAE Code 61 Flange Head - 45° Elbow

ISO 12151-3 - E450S - L (1 Piece: ISO 12151-3 - E45M - L)

# Part Number	Flange inch	Hose I.D. inch	A		E		F inch	B	
			inch	mm	inch	mm		inch	mm
11773-12-12	3/4	3/4	4.31	109	1.02	26	1-1/2	2.50	64
11773-16-16	1	1	5.01	127	1.26	32	1-3/4	3.07	78

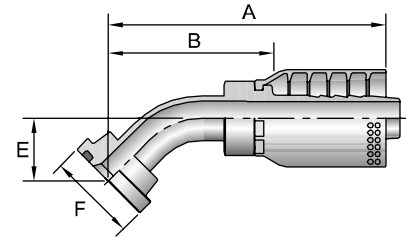

14A73

SAE Code 61 Flange Head - 5000 psi

ISO 12151-3 - S - L

# Part Number	Flange inch	Hose I.D. inch	A		F inch	B	
			inch	mm		inch	mm
14A73-20-20	1-1/4	1-1/4	5.54	141	2	3.05	77
14A73-24-24	1-1/2	1-1/2	6.53	166	2-3/8	4.22	107
14A73-32-32	2	2	6.14	156	2-13/16	3.44	87

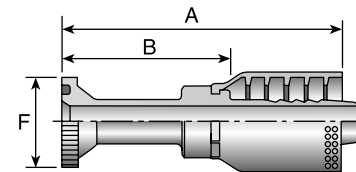

14F73

SAE Code 61 Flange Head - 45° Elbow - 5000 psi

ISO 12151-3 - E45S - L (1 Piece: ISO 12151-3 - E45M - L)

# Part Number	Flange inch	Hose I.D. inch	A		E		F inch	B	
			inch	mm	inch	mm		inch	mm
14F73-20-20	1-1/4	1-1/4	6.39	162	150	38	2	3.90	99
14F73-24-24	1-1/2	1-1/2	6.99	178	1.73	44	2-3/8	4.68	119
14F73-32-32	2	2	8.40	214	2.21	56	2-13/16	5.71	145

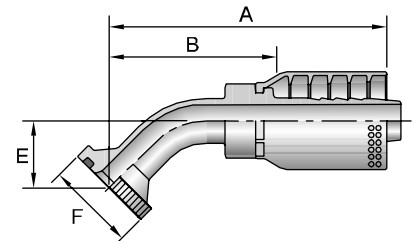

11973

SAE Code 61 Flange Head - 90° Elbow

ISO 12151-3 - E90S - L (1 Piece: ISO 12151-3 - E90M - L)

# Part Number	Flange inch	Hose I.D. inch	A		E		F inch	B	
			inch	mm	inch	mm		inch	mm
11973-12-12	3/4	3/4	3.97	101	2.28	58	1-1/2	2.16	55
11973-16-12	1	3/4	4.00	102	2.28	58	1-3/4	2.19	56
11973-16-16	1	1	4.63	118	2.76	70	1-3/4	2.69	68

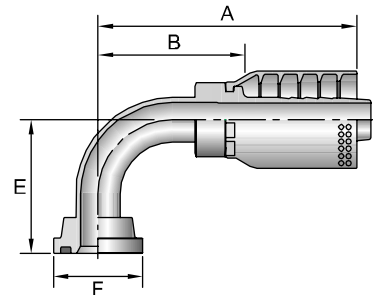

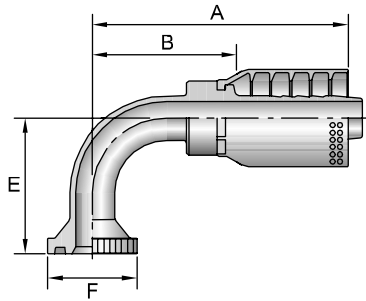

14N73

SAE Code 61 Flange Head - 90° Elbow - 5000 psi

ISO 12151-3 - E90S - L (1 Piece: ISO 12151-3 - E90M - L)

# Part Number	Flange inch	Hose I.D. inch	A		E		F inch	B	
			inch	mm	inch	mm		inch	mm
14N73-20-20	1-1/4	1-1/4	6.09	155	3.54	90	2	3.60	91
14N73-24-24	1-1/2	1-1/2	6.52	166	4.09	104	2-3/8	4.21	107
14N73-32-32	2	2	7.82	199	5.43	138	2-13/16	5.12	130

16A73

SAE Code 62 Flange Head

ISO 12151-3 - S - S

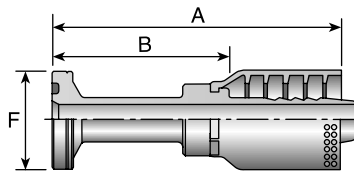

# Part Number	Flange inch	Hose I.D. inch	A		F inch	B	
			inch	mm		inch	mm
16A73-12-12	3/4	3/4	4.60	117	1-5/8	2.79	71
16A73-16-16	1	1	5.16	131	1-7/8	3.22	82
16A73-20-16	1-1/4	1	3.95	100	2-1/8	2.01	51
16A73-20-20	1-1/4	1-1/4	5.85	149	2-1/8	3.36	85
16A73-24-24	1-1/2	1-1/2	6.54	166	2-1/2	4.23	107
16A73-32-32	2	2	7.63	194	3-1/8	4.93	125

16F73

SAE Code 62 Flange Head - 45° Elbow

ISO 12151-3 - E45S - S (1 Piece: ISO 12151-3 - E45M - S)

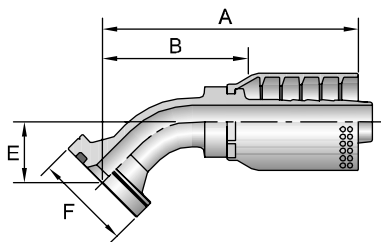

# Part Number	Flange inch	Hose I.D. inch	A		E		F inch	B	
			inch	mm	inch	mm		inch	mm
16F73-12-12	3/4	3/4	4.31	109	1.02	26	1-5/8	2.50	64
16F73-16-16	1	1	5.01	127	1.26	32	1-7/8	3.07	78
16F73-20-20	1-1/4	1-1/4	6.39	162	1.50	38	2-1/8	3.90	99

16N73

SAE Code 62 Flange Head - 90° Elbow

ISO 12151-3 - E90S - S (1 Piece: ISO 12151-3 - E90M - S)

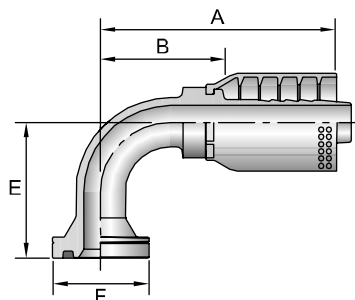

# Part Number	Flange inch	Hose I.D. inch	A		E		F inch	B	
			inch	mm	inch	mm		inch	mm
16N73-12-12	3/4	3/4	3.97	101	2.28	58	1-5/8	2.16	55
16N73-16-16	1	1	4.63	118	2.76	70	1-7/8	2.69	68
16N73-20-20	1-1/4	1-1/4	6.09	151	3.54	90	2-1/8	3.60	91
16N73-24-24	1-1/2	1-1/2	6.52	166	4.09	104	2-1/2	4.21	107
16N73-32-32	2	2	7.82	199	5.43	138	3-1/8	5.12	130

1JS73

Female Seal-Lok® - Swivel - Long

ISO 12151-1 - SWSB

# Part Number	Thread		Hose I.D. inch	A		H inch	W inch	B	
	inch	1-3/16x12		inch	mm			inch	mm
1JS73-12-12	3/4	1-3/16x12	3/4	3.70	94	1-1/8	1-3/8	1.89	48
1JS73-16-12	1	1-7/16x12	3/4	3.78	96	1-3/8	1-5/8	1.97	50
1JS73-16-16	1	1-7/16x12	1	4.03	102	1-3/8	1-5/8	2.09	53
1JS73-20-20	1-1/4	1-11/16x12	1-1/4	4.62	132	1-3/4	1-7/8	2.13	69

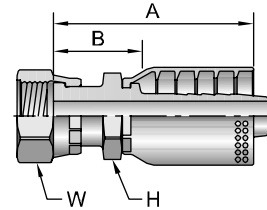

1J773

Female Seal-Lok® - Swivel - 45° Elbow

ISO 12151-1 - SWE45

# Part Number	Thread		Hose I.D. inch	A		E		W inch	B	
	inch	1-3/16x12		inch	mm	inch	mm		inch	mm
1J773-12-12	3/4	1-3/16x12	3/4	4.11	104	0.81	21	1-3/8	2.30	58
1J773-16-16	1	1-7/16x12	1	4.69	119	0.94	24	1-5/8	2.75	70
1J773-20-20	1-1/4	1-11/16x12	1-1/4	5.78	147	0.98	25	1-7/8	3.29	84

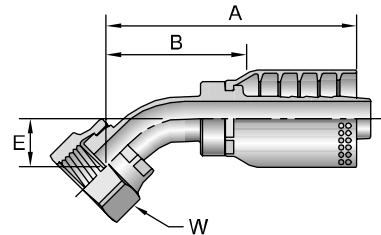

1J973

Female Seal-Lok® - Swivel - 90° Elbow - Short Drop

ISO 12151-1 - SWES90

# Part Number	Thread		Hose I.D. inch	A		E		W inch	B	
	inch	1-3/16x12		inch	mm	inch	mm		inch	mm
1J973-12-12	3/4	1-3/16x12	3/4	3.97	100	1.89	48	1-3/8	2.16	55
1J973-16-16	1	1-7/16x12	1	4.62	117	2.20	56	1-5/8	2.68	68
1J973-20-20	1-1/4	1-11/16x12	1-1/4	5.82	148	2.52	64	1-7/8	3.33	85

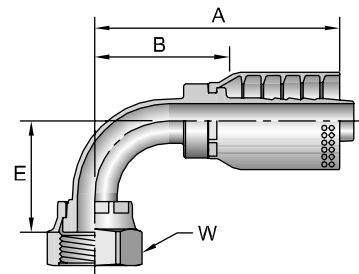

Metric S: Mates with EO "S" Series Fittings.

A

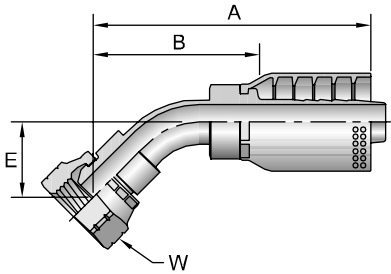

1G173

Female BSP Parallel Pipe - Swivel - 45° Elbow - (60° Cone)

# Part Number	Thread inch	Hose I.D. inch	A		E		W mm	B	
			inch	mm	inch	mm		inch	mm
1G173-12-12	3/4x14	3/4	4.77	121,2	1.35	34,4	36	2.96	75,2
1G173-16-16	1x11	1	5.36	136,1	1.52	38,7	41	3.42	86,9

B

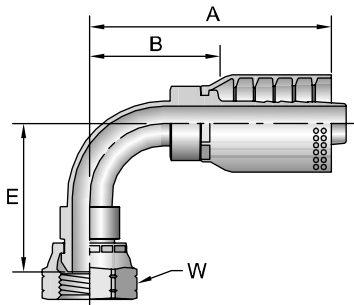

1G273

Female BSP Parallel Pipe - Swivel - 90° Elbow - (60° Cone)

# Part Number	Thread inch	Hose I.D. inch	A		E		W mm	B	
			inch	mm	inch	mm		inch	mm
1G273-12-12	3/4x14	3/4	4.12	104,6	2.62	66,6	36	2.31	58,7
1G273-16-16	1x11	1	4.71	119,6	3.04	77,2	41	2.77	70,4

C

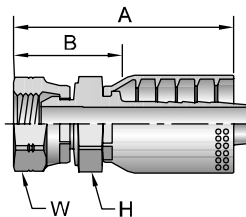

1GU73

Female BSP Parallel Pipe - Swivel - (60° Cone)

# Part Number	Thread inch	Hose I.D. inch	A		H	W	B	
			inch	mm	mm	mm	inch	mm
1GU73-12-12	3/4x14	3/4	3.76	95,5	36	36	1.95	49,5
1GU73-16-16	1x11	1	4.14	105	41	41	2.20	56

D

E

Metric S: Mates with EO "S" Series Fittings

1CA73
Female Metric L - Swivel - (24° Cone with O-Ring)
ISO 12151-2 - SWS

# Part Number	Thread mm	Hose I.D. inch	A		C		W mm	B	
			inch	mm	inch	mm		inch	mm
1CA73-28-16	25 M36x2	1	3.43	87	0.14	3.56	41	1.42	36

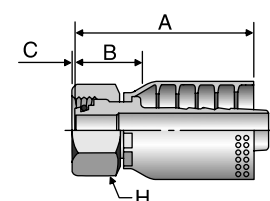

1D273
Male Metric S - Rigid - (24° Cone)
ISO 12151-2

# Part Number	Thread mm	Hose I.D. inch	A		H mm	B	
			inch	mm		inch	mm
1D273-20-12	20 M30x2	3/4	3.31	84	30	1.42	36
1D273-25-12	25 M36x2	3/4	3.39	86	36	1.50	38
1D273-30-16	30 M42x2	1	3.70	94	46	1.73	44
1D273-38-20	38 M52x2	1-1/4	4.41	112	55	1.89	48

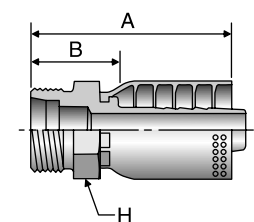

1C973
Female Metric S - Swivel - (24° Cone with O-Ring)
ISO 12151-2 - SWS

# Part Number	Thread mm	Hose I.D. inch	A		C		W mm	B	
			inch	mm	inch	mm		inch	mm
1C973-20-12	20 M30x2	3/4	3.19	81	0.05	1.3	36	1.30	33
1C973-25-12	25 M36x2	3/4	3.15	80	0.09	2.3	46	1.26	32
1C973-25-16	25 M36x2	1	3.43	87	0.09	2.3	46	1.42	36
1C973-30-16	30 M42x2	1	3.43	87	0.19	4.8	50	1.42	36
1C973-30-20	30 M42x2	1-1/4	4.17	106	0.19	4.8	50	1.65	42
1C973-38-20	38 M52x2	1-1/4	4.02	102	0.23	5.8	60	1.38	35

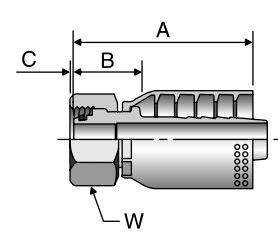

10C73
Female Metric S - Swivel - 45° Elbow - (24° Cone with O-Ring)
ISO 12151-2 - SWE45 - S

# Part Number	Thread mm	Hose I.D. inch	A		E		W mm	B	
			inch	mm	inch	mm		inch	mm
10C73-20-12	20 M30x2	3/4	4.41	112	1.10	28	36	2.52	64
10C73-25-12	25 M36x2	3/4	4.45	113	1.14	29	46	2.56	65
10C73-30-16	30 M42x2	1	5.16	131	1.34	34	50	3.19	81

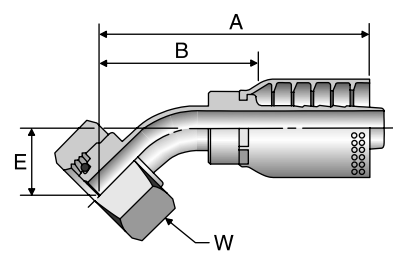

A

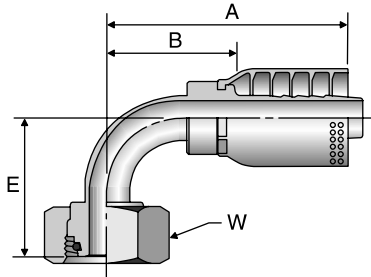

11C73

Female Metric S - Swivel - 90° Elbow - (24° Cone with O-Ring)
ISO 12151-2 - SWE - S

# Part Number	Thread mm	Hose I.D. inch	A		E		W mm	B	
			inch	mm	inch	mm		inch	mm
11C73-20-12	20 M30X2	3/4	3.98	101	2.24	57	36	2.09	53
11C73-25-12	25 M36X2	3/4	3.98	101	2.32	59	46	2.05	52
11C73-25-16	25 M36X2	1	4.80	122	2.76	70	46	2.80	71
11C73-30-16	30 M42X2	1	4.80	122	2.87	73	50	2.83	72
11C73-38-20	38 M52X2	1-1/4	5.94	151	3.07	78	60	3.43	87

B

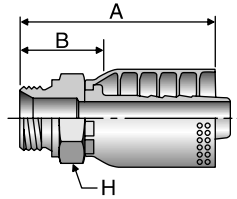

1D973

Male BSP Parallel Pipe - Rigid - (60° Cone)
ISO 228-1

# Part Number	Thread BSP	Hose I.D. inch	A		H mm	B	
			inch	mm		inch	mm
1D973-12-12	19,1 3/4x14	3/4	3.43	87	32	1.50	38
1D973-16-16	25,4 1x11	1	3.74	95	41	1.69	43

C

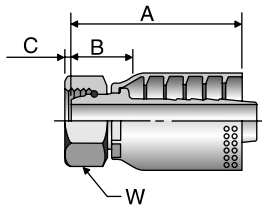

19273

Female BSP Parallel Pipe - Swivel - (60° Cone)
ISO 228-1

# Part Number	Thread inch	Hose I.D. inch	A		C		W mm	B	
			inch	mm	inch	mm		inch	mm
19273-12-12	3/4x14	3/4	3.03	77	0.46	11.7	32	1.14	29
19273-16-16	1x11	1	3.50	89	0.44	11.2	41	1.50	38
19273-20-20	1-1/4x11	1-1/4	3.98	101	0.52	13.2	50	1.46	37

D

E

1B173

Female BSP Parallel Pipe - Swivel- 45° Elbow - (60° Cone)

ISO 228-1

# Part Number	Thread inch	Hose I.D. inch	A		E		W mm	B	
			inch	mm	inch	mm		inch	mm
1B173-12-12	3/4x14	3/4	4.33	110	1.02	26	32	2.44	62
1B173-16-16	1x11	1	5.35	136	1.54	39	41	3.31	84

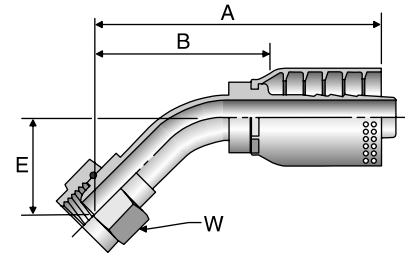

1B273

Female BSP Parallel Pipe - Swivel - 90° Elbow - (60° Cone)

ISO 228-1

# Part Number	Thread inch	Hose I.D. inch	A		E		W mm	B	
			inch	mm	inch	mm		inch	mm
1B273-12-12	3/4x14	3/4	4.17	106	2.17	55	32	2.28	58
1B273-16-16	1x11	1	4.76	121	2.99	76	41	2.76	70
1B273-20-20	1-1/4x11	1-1/4	5.94	151	3.15	80	50	3.43	87

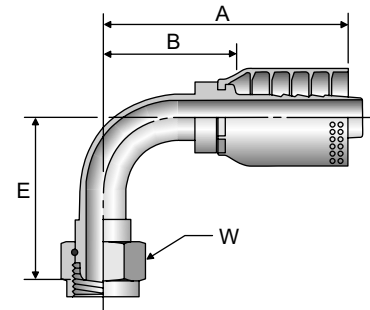

A

B

C

D

E

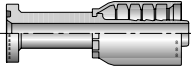
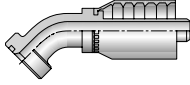
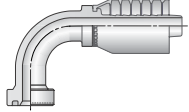
 <i>Flange</i>	18A76	B-91	18F76	B-91	18N76	B-91
						
	<i>Flange</i>		<i>45° Elbow</i>		<i>90° Elbow</i>	

A

B

C

D

E

18A76

Flange Head - 8,000 psi

# Part Number	Flange inch	Hose I.D. inch	A		F inch	B	
			inch	mm		inch	mm
18A76-12-12	3/4	3/4	5.29	134	1-5/8	2.96	75
18A76-16-16	1	1	5.72	145	1-7/8	3.17	81

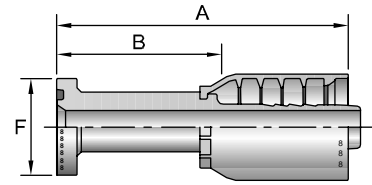

18F76

Flange Head - 45° Elbow - 8,000 psi

# Part Number	Flange inch	Hose I.D. inch	A		E		F inch	B	
			inch	mm	inch	mm		inch	mm
18F76-12-12	3/4	3/4	4.95	125,7	1.024	26	1-5/8	2.62	66,5
18F76-16-16	1	1	6.10	155,0	1.260	32	1-7/8	3.55	90,1

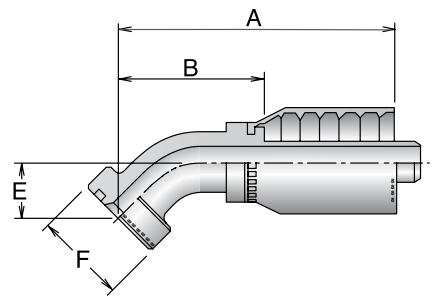







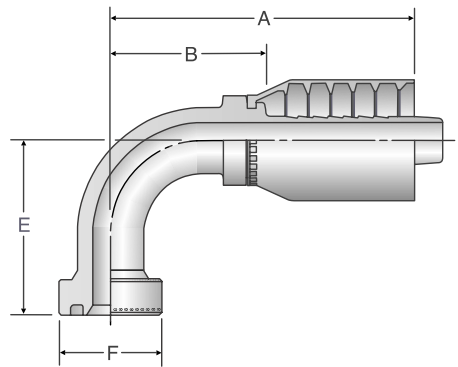



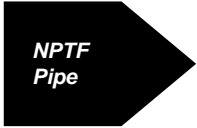
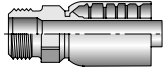

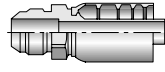
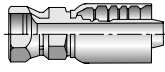
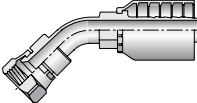
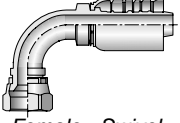

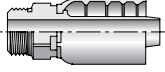

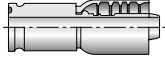
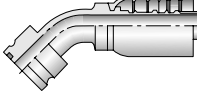
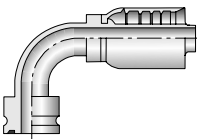

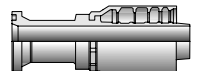
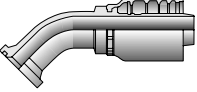
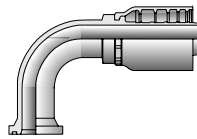
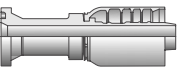
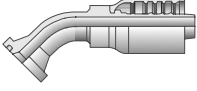
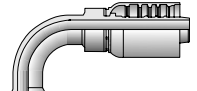

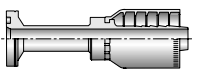
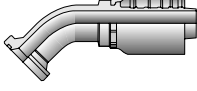
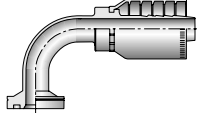

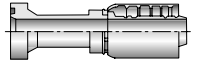

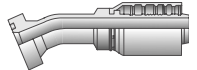
18N76

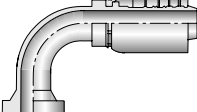
Flange Head - 90° Elbow - 8,000 psi

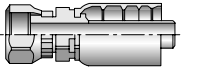
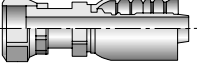
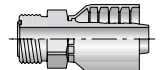
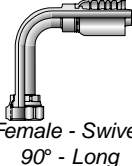
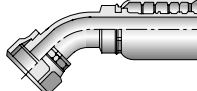
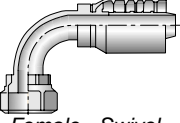
# Part Number	Flange inch	Hose I.D. inch	A		E		F inch	B	
			inch	mm	inch	mm		inch	mm
18N76-12-12	3/4	3/4	4.81	122,1	2.76	70	1-5/8	2.48	63
18N76-16-16	1	1	5.88	149,5	2.76	70	1-7/8	3.33	84,6

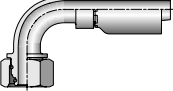
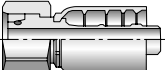
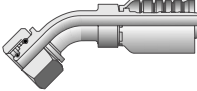
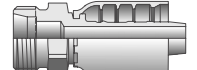

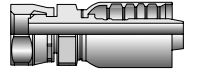
See Accessories Section for O-Rings and Flange Kits.

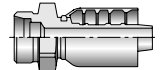
A		10177 B-97  Male - Rigid		10377 B-97  Male - Rigid	10677 B-97  Female - Swivel Straight	13777 B-98  Female - Swivel 45° Elbow - Short
	13977 B-98  Female - Swivel 90° Elbow - Short		10577 B-97  Male - Rigid		1X577 B-98  Full Flange - Straight	1X777 B-99  45° Elbow
1X977 B-99  90° Elbow		14A77 B-100  Flange Code 61	14F77 B-100  Code 61 - 45° Elbow	14N77 B-101  Code 61 - 90° Elbow	11577 B-99  Flange Code 61	
11777 B-100  Flange Code 61	11977 B-100  Flange Code 61		16A77 B-101  Flange Code 62	16F77 B-101  Code 62 45° Elbow	16N77 B-102  Code 62 90° Elbow	
	1XA77 B-102  Caterpillar® - Flange	1XF77 B-102  Caterpillar® - Flange 45° Elbow	1XB77 B-103  Caterpillar® - Flange 22-1/2° Elbow	1XG77 B-103  Caterpillar® - Flange 60° Elbow	1XN77 B-103  Flange - 90° Elbow	
	1JC77 B-104  Female - Swivel Straight - Short	1JS77 B-104  Female - Swivel Straight - Long	1J077 B-105  Male - Rigid w/O-Ring	1J177 B-105  Female - Swivel 90° - Long	1J777 B-105  Female - Swivel 45° Elbow	
1J977 B-106  Female - Swivel 90° Elbow - Short		11C77 B-106  Female - Swivel 90° Elbow	1C977 B-106  Female - Swivel Straight	10C77 B-107  Female Metric S Swivel - 45° Elbow	1D277 B-107  Male Metric S Rigid - 24° Cone	
	1GU77 B-107  Female - Swivel Straight		1ZM77 B-107  Male 20° Cone			

10177

Male NPTF Pipe - Rigid - Straight

# Part Number	Thread inch	Hose I.D. inch	A		H	B	
			inch	mm	mm	inch	mm
10177-8-8	1/2x14	1/2	2.72	69,2	22	1.50	38,2
10177-8-12	1/2x14	3/4	3.43	87,1	30	1.79	45,5
10177-12-12	3/4x14	3/4	3.43	87,1	30	1.79	45,5
10177-16-16	1x11-1/2	1	4.04	102,6	36	2.09	53,1
10177-20-20	1-1/4x11-1/2	1-1/4	4.57	116,1	46	2.30	58,4

All sizes of 10177 fittings are rated at 5,000 psi working pressure.

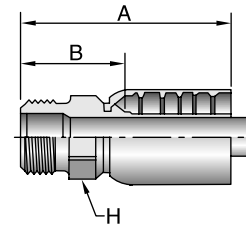

10377

Male JIC 37° - Rigid - Straight

# Part Number	Thread inch		Hose I.D. inch	A		H	B	
	inch	mm		inch	mm	mm	inch	mm
10377-8-8	1/2	3/4x16	1/2	2.61	66,4	22	1.39	35,4
10377-10-8	5/8	7/8x14	1/2	2.71	68,9	24	1.49	37,9
10377-16-16	1	1-5/16x12	1	3.99	101,3	36	2.04	51,8

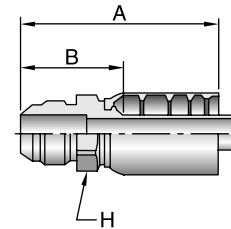

10577

Male SAE Straight Thread with O-Ring - Rigid - Straight

# Part Number	Thread inch		Hose I.D. inch	A		H	B	
	inch	mm		inch	mm	mm	inch	mm
10577-8-8	1/2	3/4x16	1/2	2.39	60,8	22	1.17	29,8
10577-12-12	3/4	1-1/16x12	3/4	3.17	80,5	32	1.53	38,9
10577-16-16	1	1-5/16x12	1	3.73	94,7	41	1.78	45,2
10577-20-20	1-1/4	1-5/8x12	1-1/4	4.17	105,9	50	1.90	48,2

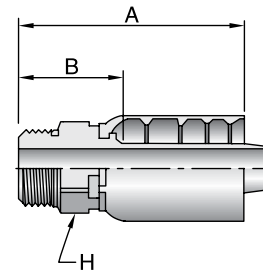

10677

Female JIC 37° - Swivel - Straight

# Part Number	Thread inch		Hose I.D. inch	A		H	W	B	
	inch	mm		inch	mm	mm	mm	inch	mm
10677-8-8	1/2	3/4x16	1/2	2.79	71,1	22	22	1.58	40,1
10677-10-8	5/8	7/8x14	1/2	2.91	74,0	22	27	1.69	43,0
10677-10-10	5/8	7/8x14	5/8	3.18	80,7	24	27	1.83	46,5
10677-12-10	3/4	1-1/16x12	5/8	3.30	83,9	30	32	1.95	49,6
10677-12-12	3/4	1-1/16x12	3/4	3.68	93,5	30	32	2.05	52,0
10677-16-12	1	1-5/16x12	3/4	3.89	98,7	36	41	2.25	57,3
10677-16-16	1	1-5/16x12	1	4.16	105,7	36	41	2.21	56,2
10677-20-16	1-1/4	1-5/8x12	1	4.29	109,1	41	50	2.34	59,5
10677-20-20	1-1/4	1-5/8x12	1-1/4	4.86	123,5	46	50	2.59	65,8

All sizes of 10677 fittings are rated at 5,000 psi working pressure.

⚠ Refer to Pressure Rating of Hose End Connections chart on page E-43.

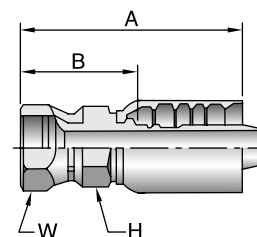

13777

Female JIC 37° - Swivel - 45° Elbow - Short Drop

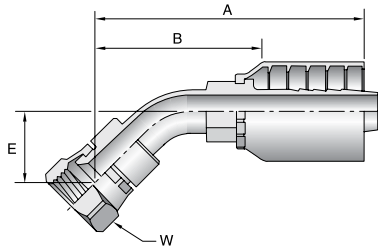

# Part Number	Thread		Hose I.D. inch	A		E		W mm	B	
	inch	3/4x16		inch	mm	inch	mm		inch	mm
13777-8-8	1/2	3/4x16	1/2	2.86	72,7	0.59	15	22	1.64	41,8
13777-12-12	3/4	1-1/16x12	3/4	4.37	110,9	0.83	21	32	2.73	69,4
13777-16-16	1	1-5/16x12	1	4.79	121,7	0.94	24	41	2.84	72,2
13777-20-20	1-1/4	1-5/8x12	1-1/4	6.03	153,2	1.26	32	50	3.76	95,5

All sizes of 13777 fittings are rated at 5,000 psi working pressure.

13977

Female JIC 37° - Swivel - 90° Elbow - Short Drop

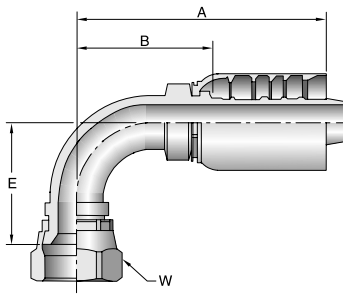

# Part Number	Thread		Hose I.D. inch	A		E		W mm	B	
	inch	3/4x16		inch	mm	inch	mm		inch	mm
13977-8-8	1/2	3/4x16	1/2	2.78	70,7	1.14	29,0	22	1.56	39,7
13977-12-12	3/4	1-1/16x12	3/4	4.23	107,4	1.89	48,0	32	2.60	66,0
13977-16-16	1	1-5/16x12	1	4.72	119,9	2.93	74,4	41	2.77	70,4
13977-20-20	1-1/4	1-5/8x12	1-1/4	5.81	147,6	3.07	78,0	50	3.54	90,0

All sizes of 13977 fittings are rated at 5,000 psi working pressure.

1X577

Full Flange - Straight - Code 61/62

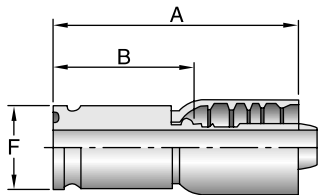

# Part Number	Flange inch	Hose I.D. inch	A		F inch	B	
			inch	mm		inch	mm
1X577-8-8	1/2	1/2	2.44	62,1	1.02	1.22	31,1
1X577-12-12	3/4	3/4	4.06	103,0	1.37	2.42	61,6
1X577-16-12	1	3/4	4.06	103,0	1.54	2.42	61,6
1X577-16-16	1	1	4.45	113,0	1.54	2.50	63,5
1X577-16-20	1	1-1/4	4.73	120,2	1.54	2.46	62,5
1X577-20-16	1-1/4	1	4.45	113,0	1.81	2.50	63,5
1X577-20-20	1-1/4	1-1/4	4.73	120,2	1.81	2.46	62,5
1X577-24-20	1-1/2	1-1/4	4.85	123,2	2.21	2.58	65,5

See Accessories Section for O-Rings and Flange Kits.

1X777

Full Flange - 45° Elbow - Code 61/62

# Part Number	Flange inch	Hose I.D. inch	A		E		F inch	B	
			inch	mm	inch	mm		inch	mm
1X777-12-12	3/4	3/4	4.67	118,5	1.12	28,5	1.37	3.03	77,0
1X777-16-12	1	3/4	4.66	118,3	1.12	28,5	1.54	3.02	76,8
1X777-16-16	1	1	5.11	129,8	1.26	32,0	1.54	3.16	80,3
1X777-16-20	1	1-1/4	5.74	145,8	1.50	38,0	1.54	3.47	88,1
1X777-20-16	1-1/4	1	5.35	135,9	1.50	38,0	1.81	3.40	86,4
1X777-20-20	1-1/4	1-1/4	6.27	159,3	1.50	38,0	1.81	4.00	101,6
1X777-24-20	1-1/2	1-1/4	6.51	165,4	1.73	44,0	2.21	4.24	107,7

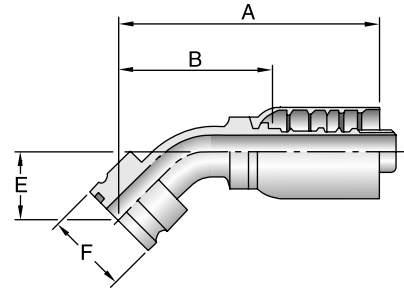

1X977

Full Flange - 90° Elbow - Code 61/62

# Part Number	Flange inch	Hose I.D. inch	A		E		F inch	B	
			inch	mm	inch	mm		inch	mm
1X977-8-8	1/2	1/2	3.14	79,8	1.69	43,0	1.02	1.92	48,9
1X977-12-12	3/4	3/4	4.24	107,6	2.38	60,5	1.37	2.60	66,1
1X977-16-12	1	3/4	4.24	107,6	2.38	60,5	1.54	2.60	66,1
1X977-12-16	3/4	1	4.33	109,9	2.76	70,0	1.37	2.38	60,5
1X977-16-16	1	1	4.73	120,1	2.76	70,0	1.54	2.78	70,6
1X977-16-20	1	1-1/4	5.12	130,1	3.54	90,0	1.54	2.85	72,4
1X977-20-16	1-1/4	1	4.73	120,1	2.76	70,0	1.81	2.78	70,6
1X977-20-20	1-1/4	1-1/4	5.81	147,6	3.54	90,0	1.81	3.54	90,0
1X977-24-20	1-1/2	1-1/4	5.81	147,6	3.54	90,0	2.21	3.54	90,0

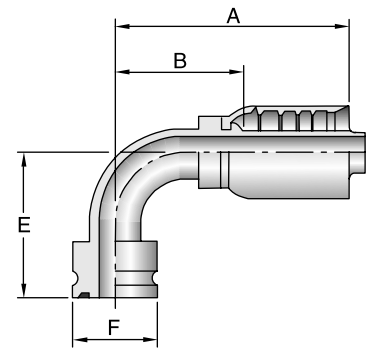

11577

SAE Code 61 Flange Head

ISO 12151-3-S-L

# Part Number	Flange inch	Hose I.D. inch	A		F inch	B	
			inch	mm		inch	mm
11577-8-8	1/2	1/2	3.52	89,6	1-3/16	2.30	58,6
11577-10-10	5/8	5/8	3.90	99,0	1-11/32	2.55	64,8
11577-12-12	3/4	3/4	4.23	107,4	1-1/2	2.59	65,9
11577-16-16	1	1	4.70	119,4	1-3/4	2.75	69,9

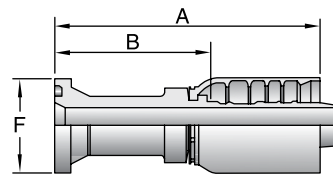

See Accessories Section for O-Rings and Flange Kits.

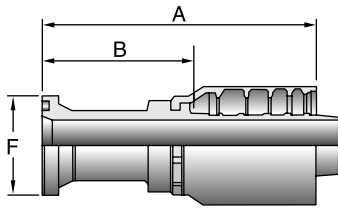

14A77

SAE Code 61 Flange Head - Straight

ISO 12151-3-S-L

# Part Number	Flange inch	Hose I.D. inch	A		F		B	
			inch	mm	inch	inch	mm	
14A77-20-20	1-1/4	1-1/4	5.42	137,7	2	3.15	80,0	
14A77-24-20	1-1/2	1-1/4	3.94	100,1	2-3/8	1.67	42,4	

11777

SAE Code 61 Flange Head - 45° Elbow

ISO 12151-3-E45S-L (1 Piece: ISO 12151-3-E45M-L)

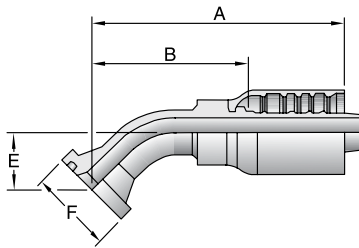

# Part Number	Flange inch	Hose I.D. inch	A		E		F		B	
			inch	mm	inch	mm	inch	inch	mm	
11777-8-8	1/2	1/2	3.11	79,0	0.79	20,0	1-3/16	1.89	48,0	
11777-12-12	3/4	3/4	4.57	116,0	1.02	26,0	1-1/2	2.93	74,5	
11777-16-16	1	1	5.11	129,8	1.26	32,0	1-3/4	3.16	80,3	

14F77

SAE Code 61 5000 psi Flange Head - 45°

ISO 12151-3 E45S-L (1 PIECE: ISO 12151-3-E45M-L)

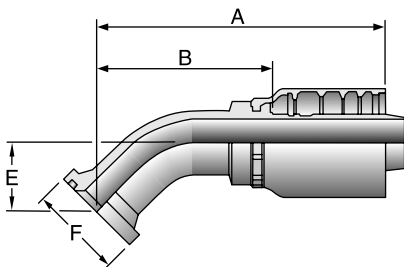

# Part Number	Flange inch	Hose I.D. inch	A		E		F		B	
			inch	mm	inch	mm	inch	inch	mm	
14F77-20-20	1-1/4	1-1/4	6.27	159,3	1.50	38	2	4.00	101,6	

11977

SAE Code 61 Flange Head - 90° Elbow

ISO 12151-3-E90S-L (1 Piece: ISO 12151-3-E90M-L)

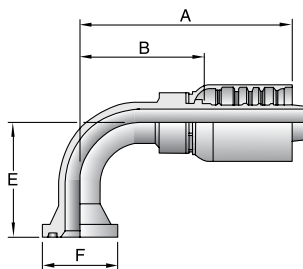

# Part Number	Flange inch	Hose I.D. inch	A		E		F		B	
			inch	mm	inch	mm	inch	inch	mm	
11977-8-8	1/2	1/2	2.99	76,0	1.61	41,0	1-3/16	1.77	45,0	
11977-12-12	3/4	3/4	4.24	107,6	2.28	58,0	1-1/2	2.60	66,1	
11977-16-16	1	1	4.72	119,9	2.76	70,0	1-3/4	2.77	70,4	

See Accessories Section for O-Rings and Flange Kits.

14N77

SAE Code 61 Flange Head - 90°

ISO 12151-3-E90S-L (1 PIECE: ISO 12151-3-E90M-L)

# Part Number	Flange inch	Hose I.D. inch	A		E		F inch	B	
			inch	mm	inch	mm		inch	mm
14N77-20-20	1-1/4	1-1/4	5.81	147,6	3.54	90	2	3.54	90,0

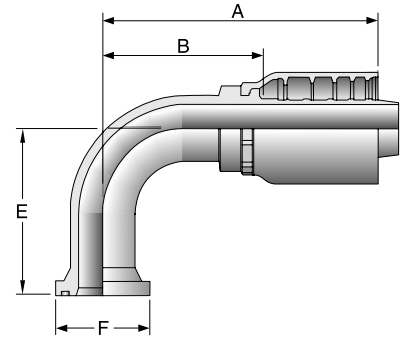

16A77

SAE Code 62 Flange Head - Straight

ISO 12151-3-S-S

# Part Number	Flange inch	Hose I.D. inch	A		F inch	B	
			inch	mm		inch	mm
16A77-12-10	3/4	5/8	2.95	74,9	1-5/8	1.60	40,7
16A77-12-12	3/4	3/4	4.49	113,9	1-5/8	2.85	72,5
16A77-16-12	1	3/4	3.47	88,1	1-7/8	1.83	46,6
16A77-16-16	1	1	5.26	133,6	1-7/8	3.31	84,1
16A77-20-16	1-1/4	1	4.05	102,9	2-1/8	2.10	53,4
16A77-20-20	1-1/4	1-1/4	5.73	145,6	2-1/8	3.46	87,8
16A77-24-20	1-1/2	1-1/4	4.65	118,1	2-1/2	2.38	60,4

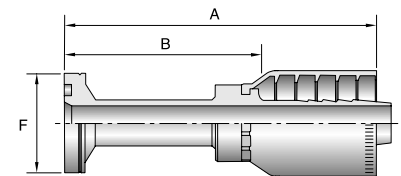

16F77

SAE Code 62 Flange Head - 45° Elbow

ISO 12151-3-E45S-S (1 PIECE: ISO 12151-3-E45M-S)

# Part Number	Flange inch	Hose I.D. inch	A		E		F inch	B	
			inch	mm	inch	mm		inch	mm
16F77-12-12	3/4	3/4	4.57	116,0	1.02	26	1-5/8	2.93	74,5
16F77-16-16	1	1	5.11	129,8	1.26	32	1-7/8	3.16	80,3
16F77-16-20	1	1-1/4	5.74	145,8	1.50	38	1-7/8	3.47	88,1
16F77-20-16	1-1/4	1	5.11	129,8	1.26	32	2-1/8	3.16	80,3
16F77-20-20	1-1/4	1-1/4	6.27	159,3	1.50	38	2-1/8	4.00	101,6
16F77-24-20	1-1/2	1-1/4	6.27	159,3	1.50	38	2-1/2	4.00	101,6

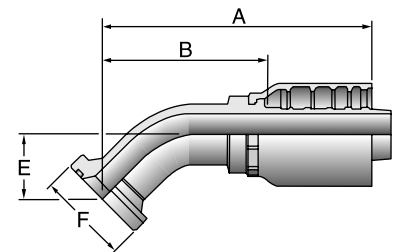





See Accessories Section for O-Rings and Flange Kits.

16N77

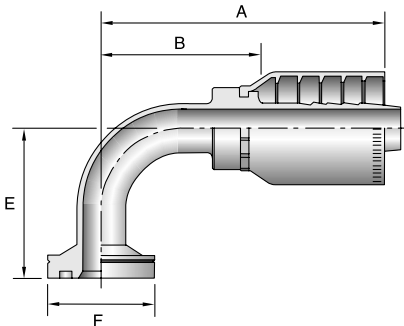
SAE Code 62 Flange Head - 90° Elbow

ISO 12151-3 - E90S - S (1 Piece: ISO 12151-3 - E90M - S)





#			A		E			B	
Part Number	Flange inch	Hose I.D. inch	inch	mm	inch	mm	inch	inch	mm
16N77-12-12	3/4	3/4	4.24	107,6	2.28	58	1-5/8	2.60	66,1
16N77-12-16	3/4	1	4.41	112,0	2.76	70	1-5/8	2.46	62,5
16N77-16-12	1	3/4	4.24	107,6	2.28	58	1-7/8	2.60	66,1
16N77-16-16	1	1	4.72	119,9	2.76	70	1-7/8	2.77	70,4
16N77-16-20	1	1-1/4	5.12	130,1	3.54	90	1-7/8	2.85	72,4
16N77-20-16	1-1/4	1	4.72	119,9	2.76	70	2-1/8	2.77	70,4
16N77-20-20	1-1/4	1-1/4	5.81	147,6	3.54	90	2-1/8	3.54	90,0
16N77-24-20	1-1/2	1-1/4	5.81	147,6	3.54	90	2-1/2	3.54	90,0

1XA77

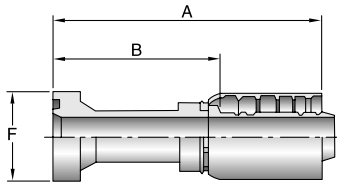
Caterpillar® Flange Head - Straight





#			A			B	
Part Number	Flange inch	Hose I.D. inch	inch	mm	inch	inch	mm
1XA77-12-12	3/4	3/4	4.48	113,7	1-5/8	2.84	72,2
1XA77-16-16	1	1	5.54	140,7	1-7/8	3.59	91,2
1XA77-20-16	1-1/4	1	4.10	104,1	2-1/8	2.15	54,6
1XA77-20-20	1-1/4	1-1/4	5.98	151,9	2-1/8	3.71	94,2

1XF77

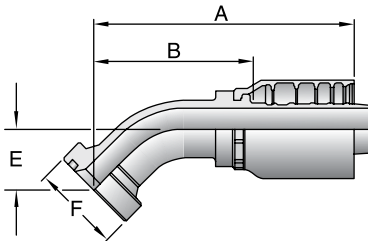
Caterpillar® Flange Head - 45° Elbow



#			A		E			B	
Part Number	Flange inch	Hose I.D. inch	inch	mm	inch	mm	inch	inch	mm
1XF77-12-12	3/4	3/4	4.57	116,0	1.22	31,0	1-5/8	2.93	74,5
1XF77-16-16	1	1	5.26	133,6	1.42	36,0	1-7/8	3.31	84,1
1XF77-20-16	1-1/4	1	5.26	133,6	1.42	36,0	2-1/8	3.31	84,1
1XF77-20-20	1-1/4	1-1/4	6.23	158,2	1.46	37,0	2-1/8	3.96	100,6
1XF77-24-20	1-1/2	1-1/4	6.23	158,2	1.46	37,0	2-1/2	3.96	100,6

See Accessories Section for O-Rings and Flange Kits.

1XB77

Caterpillar® Flange Head - 22-1/2° Elbow

# Part Number	Flange inch	Hose I.D. inch	A		E		F inch	B	
			inch	mm	inch	mm		inch	mm
1XB77-16-16	1	1	5.66	143,8	0.55	14,0	1-7/8	3.71	94,2
1XB77-20-20	1-1/4	1-1/4	6.60	167,7	0.58	14,7	2-1/8	4.33	109,9

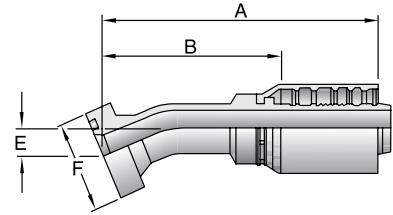

1XG77

Caterpillar® Flange Head - 60° Elbow

# Part Number	Flange inch	Hose I.D. inch	A		E		F inch	B	
			inch	mm	inch	mm		inch	mm
1XG77-12-12	3/4	3/4	5.35	135,8	1.65	42,0	1-5/8	3.71	94,3
1XG77-16-16	1	1	5.98	151,9	1.97	50,0	1-7/8	4.03	102,4
1XG77-20-20	1-1/4	1-1/4	7.74	196,6	2.01	51,0	2-1/8	5.47	138,9

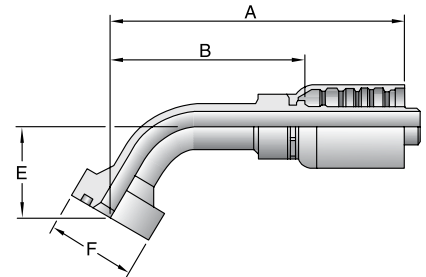

1XN77

Caterpillar® Flange Head - 90° Elbow

# Part Number	Flange inch	Hose I.D. inch	A		E		F inch	B	
			inch	mm	inch	mm		inch	mm
1XN77-12-12	3/4	3/4	4.23	107,4	2.48	63,0	1-5/8	2.59	65,9
1XN77-16-16	1	1	4.73	120,1	2.91	74,0	1-7/8	2.78	70,5
1XN77-20-16	1-1/4	1	4.73	120,1	2.91	74,0	2-1/8	2.78	70,5
1XN77-20-20	1-1/4	1-1/4	5.81	147,6	3.70	94,0	2-1/8	3.54	90,0
1XN77-24-20	1-1/2	1-1/4	5.81	147,6	3.03	77,0	2-1/2	3.54	90,0

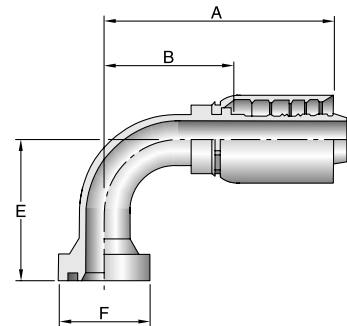

See Accessories Section for O-Rings and Flange Kits.

1JC77

Female Seal-Lok® - Swivel - Straight - Short
ISO 12151-1-SWSA

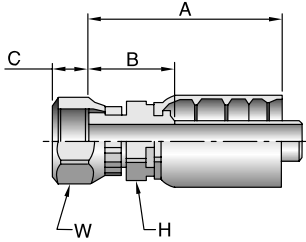

# Part Number	Thread inch	Hose I.D. inch	A		C		H		W	
			inch	mm	inch	mm	inch	inch	inch	mm
1JC77-8-8	1/2	13/16x16	2.35	59,8	0.43	11	22	24	1.13	28,8
1JC77-10-10	5/8	1x14	2.75	69,8	0.48	12	24	30	1.40	35,6

1JS77

Female Seal-Lok® - Swivel - Straight - Long
ISO 12151-1-SWSB

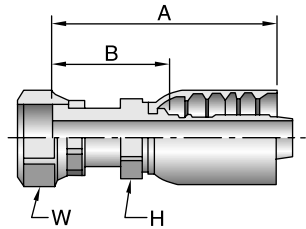

# Part Number	Thread inch	Hose I.D. inch	A		H		W		B	
			inch	mm	inch	inch	inch	mm		
1JS77-8-8	1/2	13/16x16	1/2	2.80	71,2	22	24	1.58	40,2	
1JS77-10-8	5/8	1x14	1/2	2.95	75,0	24	30	1.73	44,0	
1JS77-10-10	5/8	1x14	5/8	3.21	81,5	24	30	1.86	47,3	
1JS77-12-8	3/4	1-3/16x12	1/2	3.15	80,1	30	36	1.93	49,1	
1JS77-12-10	3/4	1-3/16x12	5/8	3.35	85,1	30	36	2.00	50,8	
1JS77-12-12	3/4	1-3/16x12	3/4	3.68	93,4	30	36	2.04	51,9	
1JS77-12-16	3/4	1-3/16x12	1	4.18	106,2	36	36	2.23	56,7	
1JS77-16-12	1	1-7/16x12	3/4	3.90	99,0	36	41	2.26	57,5	
1JS77-16-16	1	1-7/16x12	1	4.19	106,4	36	41	2.24	56,9	
1JS77-16-20	1	1-7/16x12	1-1/4	4.71	119,7	46	41	2.44	62,0	
1JS77-20-16	1-1/4	1-11/16x12	1	4.29	108,9	41	50	2.34	59,5	
1JS77-20-20	1-1/4	1-11/16x12	1-1/4	4.78	121,4	46	50	2.51	63,8	

See Accessories Section for O-Rings and Flange Kits.

1J077

Male Seal-Lok® - Rigid - Straight - (with O-Ring)

ISO 12151-1-S

# Part Number	Thread inch	Hose I.D. inch	A		H	B	
			inch	mm	mm	inch	mm
1J077-10-8	1x14	1/2	2.67	67,9	27	1.45	36,9
1J077-12-10	1-3/16x12	5/8	2.97	75,4	30	1.62	41,2
1J077-12-12	1-3/16x12	3/4	3.27	82,9	32	1.63	41,5
1J077-16-12	1-7/16x12	3/4	3.32	84,3	41	1.68	42,8
1J077-16-16	1-7/16x12	1	3.74	95,0	41	1.79	45,5
1J077-20-16	1-11/16x12	1	3.68	93,4	46	1.73	43,9

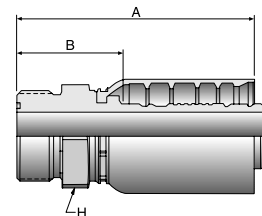

1J177

Female Seal-Lok® - Swivel - 90° Elbow - Long Drop

ISO 12151-1-SWEL90

# Part Number	Thread inch	Hose I.D. inch	A		E		W	B	
			inch	mm	inch	mm	mm	inch	mm
1J177-8-8	13/16x16	1/2	2.77	70,5	2.52	64	24	1.55	39,5
1J177-10-10	1x14	5/8	3.21	81,5	2.76	70	30	1.86	47,3
1J177-12-12	1-13/16x12	3/4	4.23	107,4	3.78	96	36	2.59	65,9
1J177-16-16	1-7/16x12	1	4.73	120,1	4.49	114	41	2.78	70,6

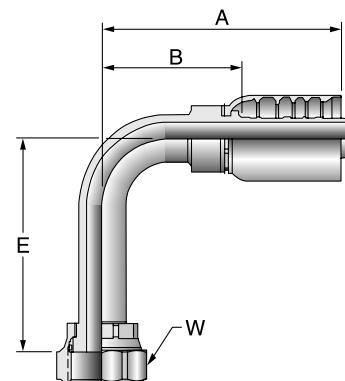

1J777

Female Seal-Lok® - Swivel - 45° Elbow

ISO 12151-1-SWE45

# Part Number	Thread inch		Hose I.D. inch	A		E		W	B	
	inch	inch		inch	mm	inch	mm	inch	inch	mm
1J777-8-8	1/2	13/16x16	1/2	2.86	72,7	0.59	15	24	1.64	41,8
1J777-10-10	5/8	1x14	5/8	3.28	83,3	0.63	16	30	1.93	49,0
1J777-12-12	3/4	1-3/16x12	3/4	4.39	111,4	0.83	21	36	2.75	69,9
1J777-16-16	1	1-7/16x12	1	4.79	121,7	0.94	24	41	2.84	72,2
1J777-20-20	1-1/4	1-11/16x12	1-1/4	5.69	144,6	0.98	25	50	3.42	86,8

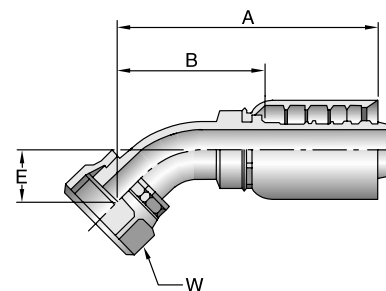

See Accessories Section for O-Rings and Flange Kits.

A

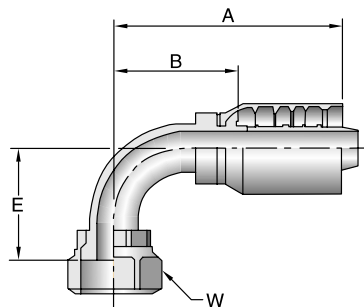

1J977

Female Seal-Lok® - Swivel - 90° Elbow - Short Drop
ISO 12151-1-SWES90

# Part Number	Thread		Hose I.D. inch	A		E		W mm	B	
	inch	mm		inch	mm	inch	mm		inch	mm
1J977-8-8	1/2	13/16x16	1/2	2.78	70,7	1.14	29	24	1.56	39,7
1J977-10-10	5/8	1x14	5/8	3.21	81,5	1.26	32	30	1.86	47,3
1J977-12-12	3/4	1-3/16x12	3/4	4.23	107,5	1.89	48	36	2.60	66,0
1J977-16-16	1	1-7/16x12	1	4.73	120,1	2.20	56	41	2.78	70,6
1J977-16-20	1	1-7/16x12	1-1/4	5.12	130,1	2.20	56	41	2.85	72,4
1J977-20-20	1-1/4	1-11/16x12	1-1/4	5.73	145,5	2.52	64	50	3.46	87,9

B

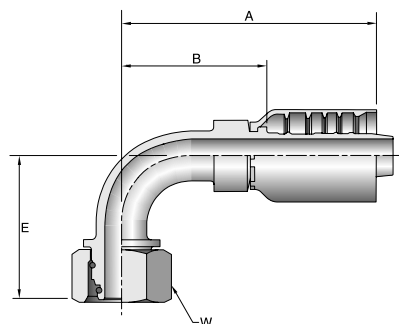

11C77

Female Metric S - Swivel - 90° Elbow - (24° Cone with O-Ring)
ISO 12151-2-SWE

# Part Number	Thread		Hose I.D. inch	A		E		W mm	B	
	inch	mm		inch	mm	inch	mm		inch	mm
11C77-16-8	M24x1,5		1/2	3.03	77	1.77	45	30	1.65	45
11C77-20-12	M30x2		3/4	4.25	108	2.36	60	36	2.44	62
11C77-25-12	M36x2		3/4	4.25	108	2.32	59	46	2.44	62
11C77-30-16	M42x2		1	5.16	131	2.72	69	50	3.03	77
11C77-38-20	M52x2		1-1/4	5.94	151	3.07	78	60	3.42	87

C

D

E

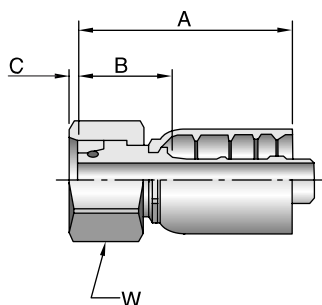

1C977

Female Metric S - Swivel - Straight (24° Cone with O-Ring)
ISO 12151-2-SWS

# Part Number	Thread		Hose I.D. inch	A		C		W mm	B	
	mm	mm		inch	mm	inch	mm		inch	mm
1C977-16-8	16	M24x1,5	1/2	2.34	59,5	0.09	2,0	30	1.12	28,5
1C977-20-10	20	M30x2	5/8	2.64	67,0	0.05	1,0	36	1.29	32,8
1C977-20-12	20	M30x2	3/4	2.99	76,0	0.07	1,9	36	1.18	30,0
1C977-25-12	25	M36x2	3/4	3.00	76,5	0.10	3,0	46	1.37	35,0
1C977-30-16	30	M42x2	1	3.50	89,0	0.19	5,0	50	1.55	39,5
1C977-38-20	38	M52x2	1-1/4	3.86	98,0	0.27	6,9	60	1.38	35,0

When measuring overall length to end of nut, B + C dimensions must be used to calculate cut-off allowance.

See Accessories Section for O-Rings and Flange Kits.

10C77

Female Metric S - Swivel - 45° Elbow - (24° Cone with O-Ring)

ISO 12151-2-SWE-45

# Part Number	Thread mm	Hose I.D. inch	A		E		W inch	B	
			inch	mm	inch	mm		inch	mm
10C77-16-8	16 M24x1,5	1/2	3.26	82,9	0.93	23,5	30	2.04	51,9
10C77-20-10	20 M30x2	5/8	4.21	106,9	1.10	28,0	36	2.86	72,7
10C77-25-12	25 M36x2	3/4	4.69	119,0	1.14	29,0	46	3.05	77,6
10C77-30-16	30 M42x2	1	5.59	142,0	1.30	33,0	50	3.64	92,5
10C77-38-20	38 M52x2	1-1/4	6.33	160,8	1.44	36,5	60	4.06	103,1

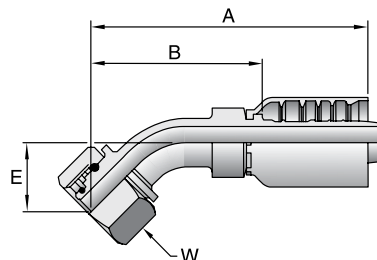

1D277

Male Metric S - Rigid - (24° Cone)

End Connection per ISO 8434-1-BHS

# Part Number	Thread mm	Hose I.D. inch	A		H mm	B	
			inch	mm		inch	mm
1D277-16-8	M24x1,5	1/2	2.53	64,4	24	1.31	33,4
1D277-20-10	M30x2	5/8	2.85	72,4	30	1.50	38,1
1D277-25-12	M36x2	3/4	3.39	86,3	36	1.76	44,8
1D277-30-16	M42x3	1	3.91	99,3	46	1.96	49,8
1D277-38-20	M52x2	1-1/4	4.50	114,3	55	2.23	56,6

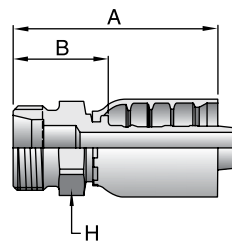

1GU77

Female BSP Parallel Pipe - Swivel - Straight (60° Cone)

# Part Number	Thread inch	Hose I.D. inch	A		H inch	W inch	B	
			inch	mm			inch	mm
1GU77-12-12	3/4x14	3/4	3.74	94,9	36	36	2.10	53,4
1GU77-16-16	1x11	1	4.33	110,0	41	41	2.38	60,5

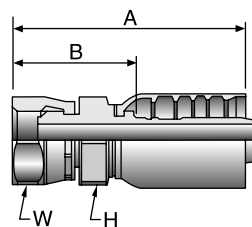







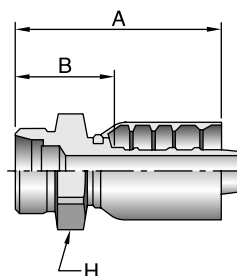

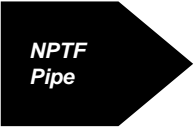
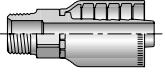

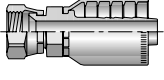
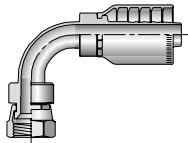

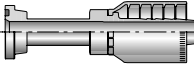
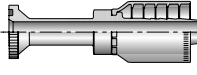
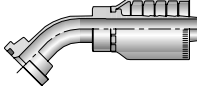
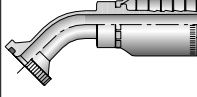
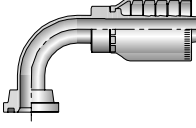
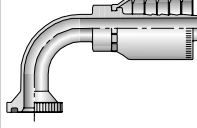

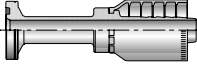
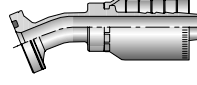
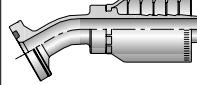
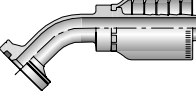
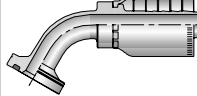
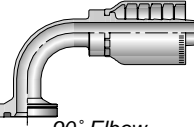

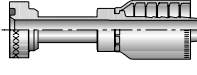
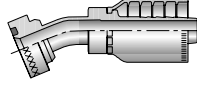
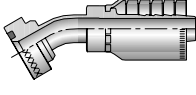
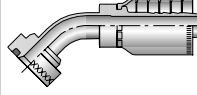
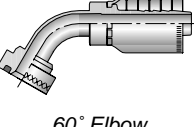
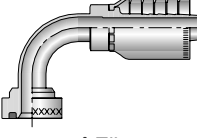

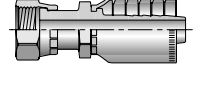
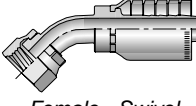
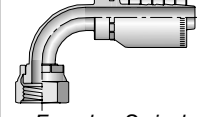

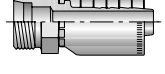

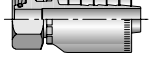
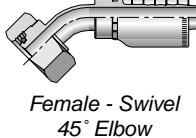
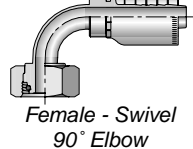

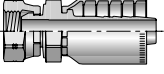

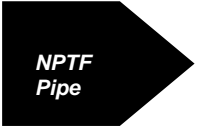
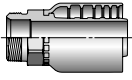
1ZM77

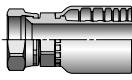
Male 24° Cone Metric - Rigid - Straight

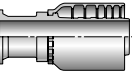
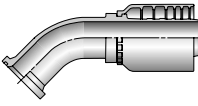
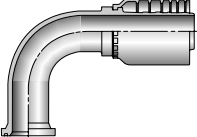
# Part Number	Thread mm	Hose I.D. inch	A		H mm	B	
			inch	mm		inch	mm
1ZM77-22-10	M30x1,5	5/8	2.83	71,8	36	1.48	37,6
1ZM77-28-12	M36x1,5	3/4	3.38	85,8	41	1.74	44,3
1ZM77-28-16	M36x1,5	1	3.77	95,8	41	1.82	46,2
1ZM77-35-16	M45x1,5	1	3.85	97,8	50	1.90	48,3

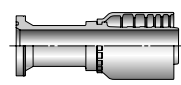
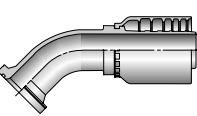
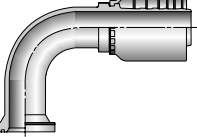

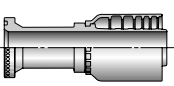
A		10178 B-110		10678 B-110	13978 B-110	
		 Male - Rigid		 Female - Swivel	 Female - Swivel	
	11578 B-110	14A78 B-111	11778 B-111	14F78 B-111	11978 B-111	14N78 B-112
	 Flange	 Flange (5000 psi)	 45° Elbow	 45° Elbow (5000 psi)	 90° Elbow	 90° Elbow (5000 psi)
B		16A78 B-112	16B78 B-112	16E78 B-112	16F78 B-113	16G78 B-113
		 Flange	 22-1/2° Elbow	 30° Elbow	 45° Elbow	 60° Elbow
C	16N78 B-113		1XA78 B-114	1XB78 B-114	1XE78 B-114	1XF78 B-115
	 90° Elbow		 Flange	 22-1/2° Elbow	 30° Elbow	 45° Elbow
D	1XG78 B-115	1XN78 B-115		1JS78 B-116	1J778 B-116	1J978 B-116
	 60° Elbow	 90° Elbow		 Female - Swivel Long	 Female - Swivel 45° Elbow	 Female - Swivel 90° Elbow - Short
E		1D278 B-117		1C978 B-117	10C78 B-117	11C78 B-117
		 Male - Rigid		 Female - Rigid	 Female - Swivel 45° Elbow	 Female - Swivel 90° Elbow
		1GU78 B-117				
		 Female - Swivel				

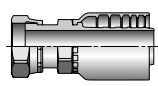
 <p>NPTF Pipe</p>	<p>101S6 B-118</p>  <p><i>Male - Rigid</i></p>	 <p>JIC 37°</p>	<p>106S6 B-118</p>  <p><i>Female - Swivel</i></p>	 <p>Code 61 Flange</p>	<p>14AS6 B-118</p>  <p><i>Flange (5000 psi)</i></p>
<p>14FS6 B-118</p>  <p><i>45° Elbow (5000 psi)</i></p>	<p>14NS6 B-118</p>  <p><i>90° Elbow (5000 psi)</i></p>	 <p>Code 62 Flange</p>	<p>16AS6 B-119</p>  <p><i>Flange Head - Straight</i></p>	<p>16FS6 B-119</p>  <p><i>45° Elbow</i></p>	<p>16NS6 B-119</p>  <p><i>90° Elbow</i></p>
 <p>Caterpillar® Flange</p>	<p>1XAS6 B-119</p>  <p><i>Flange</i></p>	 <p>Seal-Lok® (O-Ring Face Seal)</p>	<p>1JSS6 B-119</p>  <p><i>Female - Swivel</i></p>		

A

B

C

D

E

10178 Male NPTF Pipe - Rigid

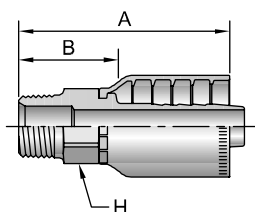

# Part Number	Thread inch	Hose I.D. inch	A		H		B	
			inch	mm	inch	inch	inch	mm
10178-12-12	3/4x14	3/4	3.56	90	1-1/8	1.80	46	
10178-16-16	1x11-1/2	1	3.94	100	1-3/8	2.09	53	
10178-20-20	1-1/4x11-1/2	1-1/4	4.92	125	1-3/4	2.53	64	
10178-24-24	1-1/2x11-1/2	1-1/2	4.88	124	2	2.67	68	

All sizes of 10178 fittings are rated at 5,000 psi working pressure.

10678 Female JIC 37° - Swivel

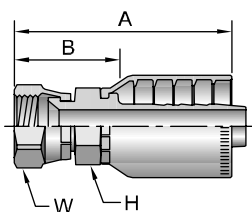

# Part Number	Thread inch	Hose I.D. inch	A		H	W	B		Additional Material Stainless Steel (C)	
			inch	mm	inch	inch	inch	mm		
10678-12-12	3/4	1-1/16x12	3/4	3.66	93	1-1/8	1-1/4	1.90	48	•
10678-16-12	1	1-5/16x12	3/4	3.90	99	1-3/8	1-1/2	2.14	54	•
10678-16-16	1	1-5/16x12	1	4.03	102	1-3/8	1-1/2	2.18	55	•
10678-20-20	1-1/4	1-5/8x12	1-1/4	4.93	125	1-3/4	2	2.54	65	•
10678-24-24	1-1/2	1-7/8x12	1-1/2	5.04	128	2	2-1/4	2.83	72	•

All sizes of 10678 fittings are rated at 5,000 psi working pressure.

⚠ Refer to Pressure Rating of Hose End Connections chart on page E-43.

13978 Female JIC 37° - Swivel - 90° Elbow - Short Drop

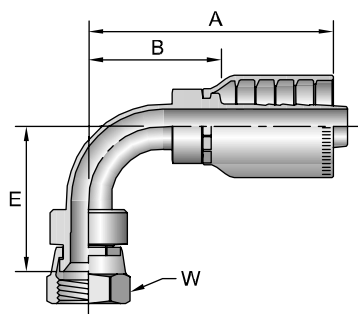

# Part Number	Thread inch	Hose I.D. inch	A		E		W	B		
			inch	mm	inch	mm	inch	inch	mm	
13978-12-12	3/4	1-1/16x12	3/4	4.12	105	2.44	62	1-1/2	2.36	60
13978-16-16	1	1-5/16x12	1	4.71	120	2.93	74	1-1/2	2.86	73
13978-20-20	1-1/4	1-5/8x12	1-1/4	5.67	144	3.35	85	2	3.28	83

All sizes of 13978 fittings are rated at 5,000 psi working pressure.

11578 SAE Code 61 Flange Head ISO 12151-3 - S - L

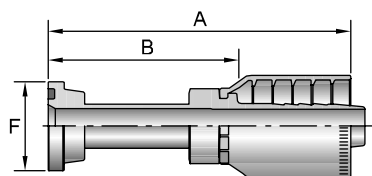

# Part Number	Flange inch	Hose I.D. inch	A		F	B	
			inch	mm	inch	inch	mm
11578-12-12	3/4	3/4	4.34	110	1-1/2	2.58	66
11578-16-16	1	1	4.59	117	1-3/4	2.74	70

See Accessories Section for O-Rings and Flange Kits.

14A78

SAE Code 61 Flange Head - 5,000 psi

ISO 12151-3 - S - L (5000 psi)

# Part Number	Flange inch	Hose I.D. inch	A		F inch	B	
			inch	mm		inch	mm
14A78-20-20	1-1/4	1-1/4	5.54	141	2	3.15	80
14A78-24-24	1-1/2	1-1/2	6.53	166	2-3/8	4.32	110
14A78-32-24	2	1-1/2	4.68	119	2-13/16	2.47	63

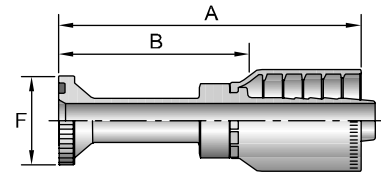

11778

SAE Code 61 Flange Head - 45° Elbow

ISO 12151-3 - E45S - L (1 Piece: ISO 12151-3 - E45M - L)

# Part Number	Flange inch	Hose I.D. inch	A		E		F inch	B	
			inch	mm	inch	mm		inch	mm
11778-12-12	3/4	3/4	4.67	119	1.06	27	1-1/2	2.91	74
11778-16-16	1	1	5.01	127	1.26	32	1-3/4	3.16	80

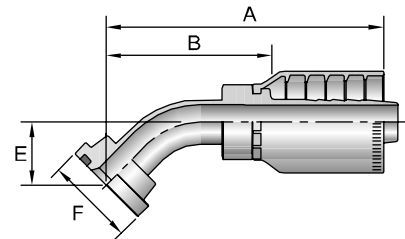

14F78

SAE Code 61 Flange Head - 45° Elbow - 5,000 psi

ISO 12151-3 - E45S - L (1 Piece: ISO 12151-3 - E45M - L) (5000 psi)

# Part Number	Flange inch	Hose I.D. inch	A		E		F inch	B	
			inch	mm	inch	mm		inch	mm
14F78-20-20	1-1/4	1-1/4	6.39	162	1.50	38	2	4.00	102
14F78-24-24	1-1/2	1-1/2	6.99	178	1.73	44	2-3/8	4.78	121

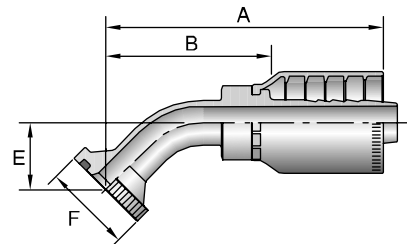

11978

SAE Code 61 Flange Head - 90° Elbow

ISO 12151-3 - E90S - L (1 Piece: ISO 12151-3 - E90M - L)

# Part Number	Flange inch	Hose I.D. inch	A		E		F inch	B	
			inch	mm	inch	mm		inch	mm
11978-12-12	3/4	3/4	4.35	110	2.25	57	1-1/2	2.59	66
11978-16-16	1	1	4.67	119	2.76	70	1-3/4	2.82	72

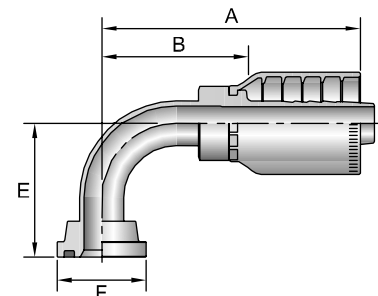

See Accessories Section for O-Rings and Flange Kits.

14N78

SAE Code 61 Flange Head - 90° Elbow - 5,000 psi

ISO 12151-3 - E90S - L (1 Piece: ISO 12151-3 - E90M - L) (5000 psi)

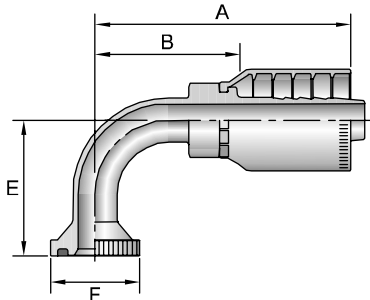

# Part Number	Flange inch	Hose I.D. inch	A		E		F		B	
			inch	mm	inch	mm	inch	inch	mm	
14N78-20-16	1-1/4	1	4.63	118	2.76	70	2	2.78	71	
14N78-20-20	1-1/4	1-1/4	6.09	155	3.54	90	2	3.70	94	
14N78-24-24	1-1/2	1-1/2	6.52	166	4.09	104	2-3/8	4.31	109	

16A78

SAE Code 62 Flange Head

ISO 12151-3 - S - S

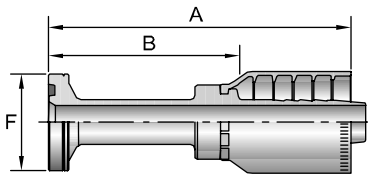

# Part Number	Flange inch	Hose I.D. inch	A		F	B	
			inch	mm	inch	inch	mm
16A78-12-12	3/4	3/4	4.60	117	1-5/8	2.84	72
16A78-16-12	1	3/4	3.57	91	1-7/8	1.81	46
16A78-16-16	1	1	5.16	131	1-7/8	3.31	84
16A78-20-16	1-1/4	1	3.95	100	2-1/8	2.10	53
16A78-20-20	1-1/4	1-1/4	5.85	149	2-1/8	3.46	88
16A78-24-20	1-1/2	1-1/4	4.77	121	2-1/2	2.38	60
16A78-24-24	1-1/2	1-1/2	6.54	166	2-1/2	4.33	110
16A78-32-24	2	1-1/2	5.07	129	3-1/8	2.86	73

16B78

SAE Code 62 Flange Head - 22-1/2° Elbow

ISO 12151-3 - E22M - S

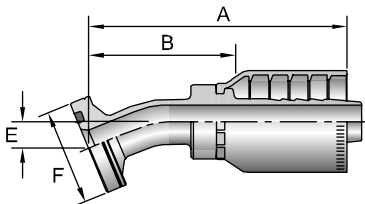

# Part Number	Flange inch	Hose I.D. inch	A		E		F		B	
			inch	mm	inch	mm	inch	inch	mm	
16B78-16-16	1	1	4.57	116	0.46	12	1-7/8	2.72	60	

16E78

SAE Code 62 Flange Head - 30° Elbow

ISO 12151-3 - E30S - S (1 Piece: ISO 12151-3 - E30M - S)

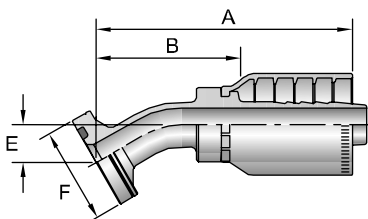

# Part Number	Flange inch	Hose I.D. inch	A		E		F		B	
			inch	mm	inch	mm	inch	inch	mm	
16E78-20-20	1-1/4	1-1/4	6.71	170	0.87	22	2-1/8	4.32	110	
16E78-24-24	1-1/2	1-1/2	7.10	180	1.12	28	2-1/2	4.89	124	

See Accessories Section for O-Rings and Flange Kits.

16F78

SAE Code 62 Flange Head - 45° Elbow

ISO 12151-3 - E45S - S (1 Piece: ISO 12151-3 - E45M - S)

# Part Number	Flange inch	Hose I.D. inch	A		E		F inch	B	
			inch	mm	inch	mm		inch	mm
16F78-12-12	3/4	3/4	4.31	109	1.02	26	1-5/8	2.55	65
16F78-16-12	1	3/4	4.83	123	1.22	31	1-7/8	3.07	78
16F78-16-16	1	1	5.04	128	1.26	32	1-7/8	3.19	81
16F78-20-16	1-1/4	1	5.01	127	1.26	32	2-1/8	3.16	80
16F78-20-20	1-1/4	1-1/4	6.39	162	1.50	38	2-1/8	4.00	102
16F78-24-20	1-1/2	1-1/4	6.39	162	1.50	38	2-1/2	4.00	102
16F78-24-24	1-1/2	1-1/2	6.99	178	1.73	44	2-1/2	4.78	121

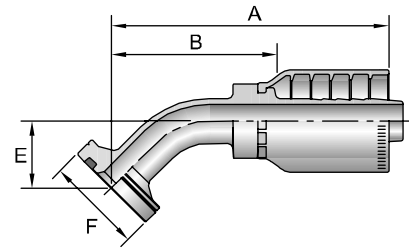

16G78

SAE Code 62 Flange Head - 60° Elbow

ISO 12151-3 - E60S - S (1 Piece: ISO 12151-3 - E60M - S)

# Part Number	Flange inch	Hose I.D. inch	A		E		F inch	B	
			inch	mm	inch	mm		inch	mm
16G78-16-16	1	1	5.85	149	1.73	44	1-7/8	4.00	102
16G78-20-20	1-1/4	1-1/4	7.72	196	2.17	55	2-1/8	5.33	135
16G78-24-24	1-1/2	1-1/2	8.41	214	2.52	64	2-1/2	6.20	157

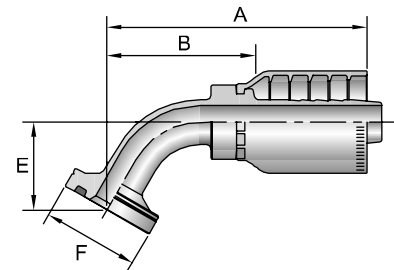

16N78

SAE Code 62 Flange Head - 90° Elbow

ISO 12151-3 - E90S - S (1 Piece: ISO 12151-3 - E90M - S)

# Part Number	Flange inch	Hose I.D. inch	A		E		F inch	B	
			inch	mm	inch	mm		inch	mm
16N78-12-12	3/4	3/4	4.00	102	2.28	58	1-5/8	2.24	57
16N78-16-12	1	3/4	3.97	101	2.28	58	1-7/8	2.21	56
16N78-16-16	1	1	4.63	118	2.76	70	1-7/8	2.78	71
16N78-20-16	1-1/4	1	4.63	118	2.76	70	2-1/8	2.78	71
16N78-20-20	1-1/4	1-1/4	6.09	155	3.54	90	2-1/8	3.70	94
16N78-24-16	1-1/2	1	5.04	126	2.70	69	2-1/2	3.19	81
16N78-24-20	1-1/2	1-1/4	6.09	155	3.54	90	2-1/2	3.70	94
16N78-24-24	1-1/2	1-1/2	6.52	166	4.09	104	2-1/2	4.31	109
16N78-32-24	2	1-1/2	6.52	166	4.09	104	3-1/8	4.31	109

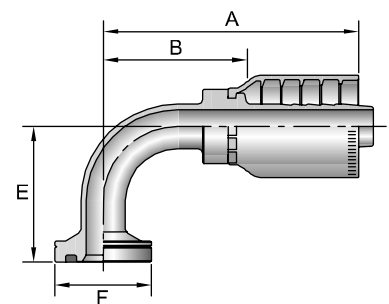

See Accessories Section for O-Rings and Flange Kits.

1XA78 Caterpillar® Flange Head

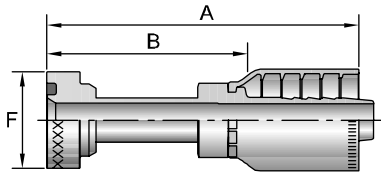

# Part Number	Flange inch	Hose I.D. inch	A		F inch	B	
			inch	mm		inch	mm
1XA78-12-12	3/4	3/4	4.85	123,2	1-5/8	3.09	78,5
1XA78-16-12	1	3/4	5.29	134,4	1-7/8	3.53	89,7
1XA78-16-16	1	1	5.44	138,2	1-7/8	3.59	91,2
1XA78-20-16	1-1/4	1	5.65	143,5	2-1/8	3.80	96,5
1XA78-20-20	1-1/4	1-1/4	6.10	154,9	2-1/8	3.71	94,2
1XA78-24-20	1-1/2	1-1/4	6.35	161,3	2-1/2	3.96	100,6
1XA78-24-24	1-1/2	1-1/2	6.78	172,2	2-1/2	4.57	116,1

1XB78 Caterpillar® Flange Head - 22-1/2° Elbow

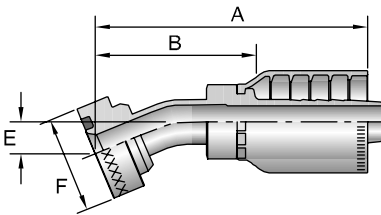

# Part Number	Flange inch	Hose I.D. inch	A		E		F inch	B	
			inch	mm	inch	mm		inch	mm
1XB78-12-12	3/4	3/4	4.59	117	0.54	14	1-5/8	2.83	72
1XB78-16-16	1	1	4.66	118	0.50	13	1-7/8	2.81	71
1XB78-20-16	1-1/4	1	4.66	118	0.50	13	2-1/8	2.81	71
1XB78-20-20	1-1/4	1-1/4	7.21	183	0.80	20	2-1/8	4.82	122
1XB78-24-20	1-1/2	1-1/4	7.21	183	0.80	20	2-1/2	4.82	122
1XB78-24-24	1-1/2	1-1/2	7.08	180	0.73	19	2-1/2	4.87	124

1XE78 Caterpillar® Flange Head - 30° Elbow

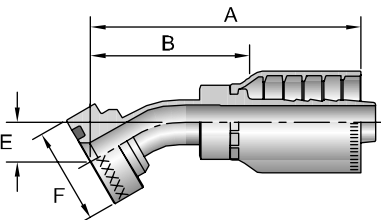

# Part Number	Flange inch	Hose I.D. inch	A		E		F inch	B	
			inch	mm	inch	mm		inch	mm
1XE78-16-16	1	1	5.08	129	0.79	20	1-7/8	3.23	82
1XE78-20-16	1-1/4	1	5.10	128	0.80	20	2-1/8	3.25	83
1XE78-20-20	1-1/4	1-1/4	6.38	162	0.93	24	2-1/8	3.99	101
1XE78-24-20	1-1/2	1-1/4	6.38	162	0.93	24	2-1/2	3.99	101
1XE78-24-24	1-1/2	1-1/2	7.10	180	1.14	29	2-1/2	4.89	124

Caterpillar® style fittings conform to the bolt hole patterns of SAE Code 62 and require special flange halves and seals. The Caterpillar® style flange heads are thicker than SAE Code 62 and measure to a .560" thickness in all sizes.

See Accessories Section for O-Rings and Flange Kits.

1XF78

Caterpillar® Flange Head - 45° Elbow

# Part Number	Flange inch	Hose I.D. inch	A		E		F inch	B	
			inch	mm	inch	mm		inch	mm
1XF78-12-12	3/4	3/4	4.82	122	1.21	31	1-5/8	3.06	78
1XF78-16-12	1	3/4	4.81	120	1.20	30	1-7/8	3.05	77
1XF78-16-16	1	1	5.46	139	1.43	36	1-7/8	3.61	92
1XF78-20-16	1-1/4	1	5.46	139	1.43	36	2-1/8	3.61	92
1XF78-20-20	1-1/4	1-1/4	6.38	162	1.44	37	2-1/8	3.99	101
1XF78-24-20	1-1/2	1-1/4	6.38	162	1.44	37	2-1/2	3.99	101
1XF78-24-24	1-1/2	1-1/2	6.89	175	1.54	39	2-1/2	4.68	119

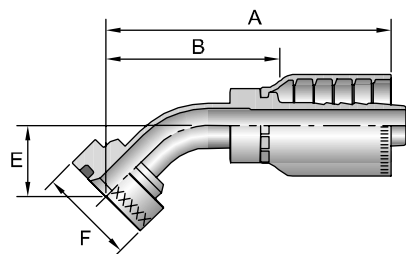

1XG78

Caterpillar® Flange Head - 60° Elbow

# Part Number	Flange inch	Hose I.D. inch	A		E		F inch	B	
			inch	mm	inch	mm		inch	mm
1XG78-16-16	1	1	5.13	130	1.96	50	1-7/8	3.28	83
1XG78-20-20	1-1/4	1-1/4	6.72	171	2.02	51	2-1/8	4.33	110
1XG78-24-24	1-1/2	1-1/2	6.87	174	2.04	52	2-1/2	4.67	119

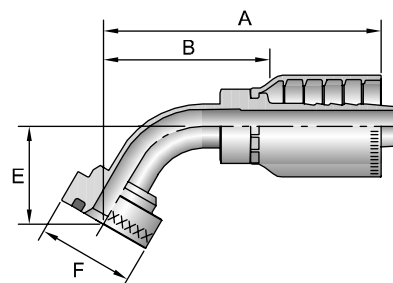

1XN78

Caterpillar® Flange Head - 90° Elbow

# Part Number	Flange inch	Hose I.D. inch	A		E		F inch	B	
			inch	mm	inch	mm		inch	mm
1XN78-12-12	3/4	3/4	4.35	110	2.46	62	1-5/8	2.59	66
1XN78-12-16	3/4	1	4.58	116	2.46	62	1-5/8	2.73	69
1XN78-16-12	1	3/4	4.35	110	2.44	62	1-7/8	2.59	66
1XN78-16-16	1	1	5.04	128	2.90	74	1-7/8	3.19	81
1XN78-20-16	1-1/4	1	5.04	128	2.90	74	2-1/8	3.19	81
1XN78-20-20	1-1/4	1-1/4	6.75	171	3.02	77	2-1/8	4.36	111
1XN78-24-20	1-1/2	1-1/4	6.75	171	3.02	77	2-1/2	4.36	111
1XN78-24-24	1-1/2	1-1/2	5.85	149	3.41	87	2-1/2	3.64	92

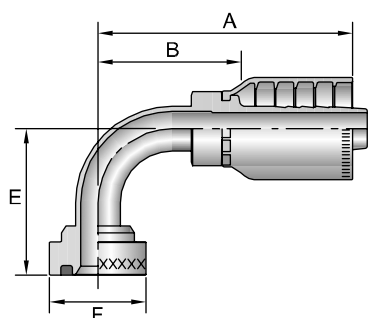

Caterpillar® style fittings conform to the bolt hole patterns of SAE Code 62 and require special flange halves and seals. The Caterpillar® style flange heads are thicker than SAE Code 62 and measure to a .560" thickness in all sizes.

See Accessories Section for O-Rings and Flange Kits.

A

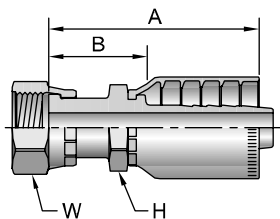

1JS78

Female Seal-Lok® - Swivel - Long
ISO 12151-1 - SWSB

# Part Number	Thread		Hose I.D. inch	A		H inch	W inch	B	
	inch	inch		inch	mm			inch	mm
1JS78-12-12	3/4	1-3/16x12	3/4	3.70	94	1-1/8	1-3/8	1.94	49
1JS78-16-16	1	1-7/16x12	1	4.03	102	1-3/8	1-5/8	2.18	55
1JS78-20-16	1-1/4	1-11/16x12	1	3.99	101	1-3/4	1-7/8	2.14	54
1JS78-20-20	1-1/4	1-11/16x12	1-1/4	4.62	117	1-3/4	1-7/8	2.23	57
1JS78-24-24	1-1/2	2-12	1-1/2	4.70	119,4	2	2-1/4	2.49	63,2

⚠ Refer to Pressure Rating of Hose End Connections chart on page E-43.

B

1J778

Female Seal-Lok® - Swivel - 45° Elbow
ISO 12151-1 - SWE45

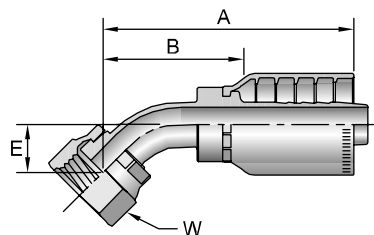

# Part Number	Thread		Hose I.D. inch	A		E		W inch	B	
	inch	inch		inch	mm	inch	mm		inch	mm
1J778-12-12	3/4	1-3/16x12	3/4	4.11	104	0.81	21	1-3/8	2.35	60
1J778-16-16	1	1-7/16x12	1	4.69	119	0.94	24	1-5/8	2.84	72
1J778-20-20	1-1/4	1-11/16x12	1-1/4	5.78	147	0.98	25	1-7/8	3.29	84
1J778-24-24	1-1/2	2x12	1-1/2	6.91	176	1.56	40	2-1/4	4.70	119

⚠ Refer to Pressure Rating of Hose End Connections chart on page E-43.

D

1J978

Female Seal-Lok® - Swivel - 90° Elbow - Short Drop
ISO 12151-1 - SWES90

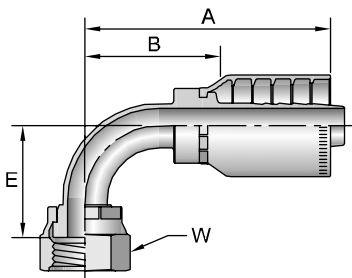

# Part Number	Thread		Hose I.D. inch	A		E		W inch	B	
	inch	inch		inch	mm	inch	mm		inch	mm
1J978-12-12	3/4	1-3/16x12	3/4	3.97	100	1.89	48	1-3/8	2.21	56
1J978-16-16	1	1-7/16x12	1	4.62	117	2.21	56	1-5/8	2.77	70
1J978-20-20	1-1/4	1-11/16x12	1-1/4	5.82	148	2.52	64	1-7/8	3.43	87
1J978-24-24	1-1/2	2x12	1-1/2	6.58	167	2.70	69	2-1/4	4.37	111

⚠ Refer to Pressure Rating of Hose End Connections chart on page E-43.

See Accessories Section for O-Rings and Flange Kits.

1D278

Male Metric S - Rigid - (24° Cone)

# Part Number	Thread		Hose I.D. inch	A		H mm	B	
	mm	M		inch	mm		inch	mm
1D278-25-12	25	M36x2	3/4	3.38	86	36	1.62	41
1D278-30-16	30	M42x2	1	3.72	94	46	1.87	47
1D278-38-20	38	M52x2	1-1/4	4.42	112	55	2.03	52

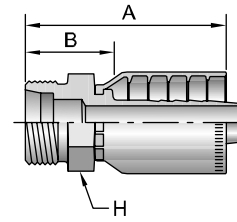

1C978

Female Metric S - Swivel - (24° Cone with O-Ring)

# Part Number	Thread		Hose I.D. inch	A		C		W mm	B	
	mm	M		inch	mm	inch	mm		inch	mm
1C978-25-12	25	M36x2	3/4	3.12	79	0.10	3	46	1.36	35
1C978-30-16	30	M42x2	1	3.40	86	0.19	5	50	1.55	39
1C978-38-20	38	M52x2	1-1/4	3.98	101	0.23	6	60	1.59	40

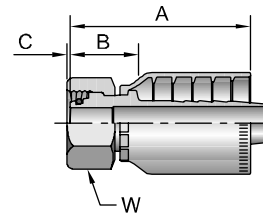

When measuring overall length to the end of the nut, B+C dimensions must be used to calculate cut-off allowance.

10C78

Female Metric S - Swivel - 45° Elbow - (24° Cone with O-Ring)
ISO 12151-2 - SWE45 - S

# Part Number	Thread		Hose I.D. inch	A		E		W mm	B	
	mm	M		inch	mm	inch	mm		inch	mm
10C78-25-12	25	M36x2	3/4	4.45	113	1.14	29	46	2.56	65
10C78-30-16	30	M42x2	1	5.16	131	1.34	34	50	3.19	81
10C78-38-20	38	M52x2	1-1/4	6.44	164	1.50	38	60	4.05	103

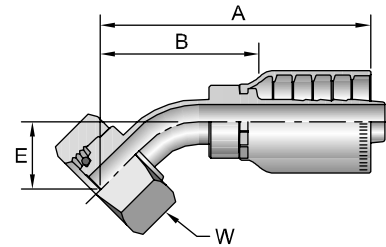

11C78

Female Metric S - Swivel - 90° Elbow - (24° Cone with O-Ring)
ISO 12151-2 - SWE - S

# Part Number	Thread		Hose I.D. inch	A		E		W mm	B	
	mm	M		inch	mm	inch	mm		inch	mm
11C78-25-12	25	M36x2	3/4	4.12	105	2.32	59	46	2.36	60
11C78-30-16	30	M42x2	1	4.71	120	2.68	68	50	2.86	73
11C78-38-20	38	M52x2	1-1/4	5.67	144	2.86	73	60	3.28	83

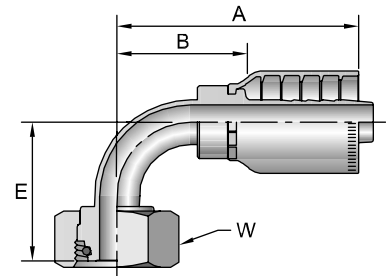

1GU78

Female BSP Parallel Pipe - Swivel - (60° Cone)

# Part Number	Thread		Hose I.D. inch	A		H mm	W mm	B	
	inch	BSP		inch	mm			inch	mm
1GU78-12-12	3/4	x14	3/4	3.76	96	36	36	2.00	51
1GU78-16-16	1	x11	1	4.14	105	41	41	2.29	58

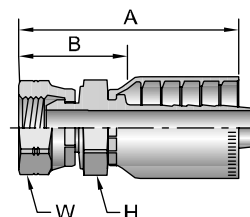

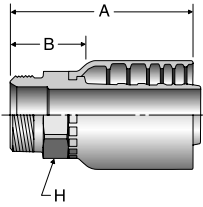

Metric S: Mates with EO "S" Series Fittings. See Accessories Section for O-Rings and Flange Kits.

A



101S6

Male NPTF Pipe - Rigid

#			A		H	B	
Part Number	Thread inch	Hose I.D. inch	inch	mm	inch	inch	mm
101S6-32-32	2 x 11 1/2	2	5.88	149,5	2-1/2	2.44	61,9

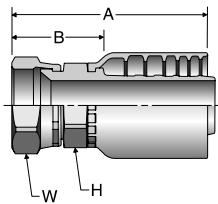

101S6 is rated at 5,000 psi working pressure.

B



106S6

Female JIC 37° - Swivel

#			A		H	B	
Part Number	Thread inch	Hose I.D. inch	inch	mm	inch	inch	mm
106S6-32-32	2 1/2 x 12	2	6.52	165,7	2.5	3.08	78,2

106S6 is rated at 5,000 psi working pressure.

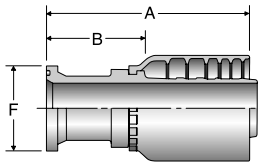

C



14AS6

SAE Code 61 Flange Head - 5,000 psi

ISO 12151-3-S-L (5,000 psi)

#			A		F	B		E	
Part Number	Flange inch	Hose I.D. inch	inch	mm	inch	inch	mm	inch	mm
14AS6-32-32	2	2	6.72	170,8	2-13/16	3.28	83,3	-	-

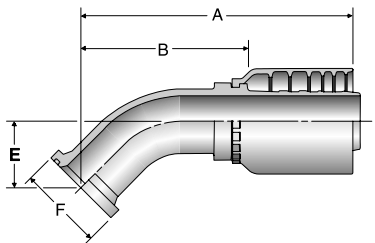

D



14FS6

SAE Code 61 Flange Head - 45° Elbow - 5,000 psi

ISO 12151-3-E-45S-L (1 Piece: ISO 12151-3-E45M-L) (5,000 psi)

#			A		F	B		E	
Part Number	Flange inch	Hose I.D. inch	inch	mm	inch	inch	mm	inch	mm
14FS6-32-32	2	2	8.70	221,1	2-13/16	5.26	133,6	2.205	56,0

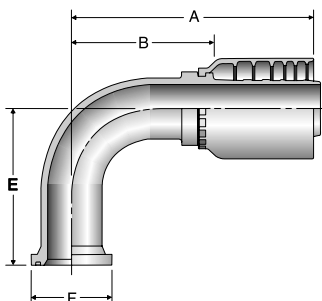

E



14NS6

SAE Code 61 Flange Head - 90° Elbow - 5,000 psi

ISO 12151-3-E-90S-L (1 Piece: ISO 12151-3-E90M-L) (5,000 psi)

#			A		F	B		E	
Part Number	Flange inch	Hose I.D. inch	inch	mm	inch	inch	mm	inch	mm
14NS6-32-32	2	2	8.41	213,7	2-13/16	4.97	126,2	5.433	138,0

16AS6

SAE Code 62 Flange Head

ISO 12151-3-S-S

# Part Number	Flange inch	Hose I.D. inch	A		F	B		E	
			inch	mm	inch	inch	mm	inch	mm
16AS6-32-32	2	2	8.21	208,6	3-1/8	4.77	121,1	-	-

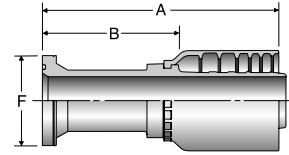

16FS6

SAE Code 62 Flange Head - 45° Elbow

ISO 12151-3-E45S-S (1 Piece: ISO 1251-3-E45-M-S)

# Part Number	Flange inch	Hose I.D. inch	A		F	B		E	
			inch	mm	inch	inch	mm	inch	mm
16FS6-32-32	2	2	8.70	221,1	3-1/8	5.26	133,6	2.205	56,0

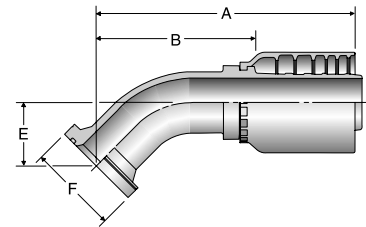

16NS6

SAE Code 62 Flange Head - 90° Elbow

ISO 12151-3-E90S-S (1 Piece: ISO 1251-3-E90M-S)

# Part Number	Flange inch	Hose I.D. inch	A		F	B		E	
			inch	mm	inch	inch	mm	inch	mm
16NS6-32-32	2	2	8.41	213,7	3-1/8	4.97	126,2	5.43	138,0

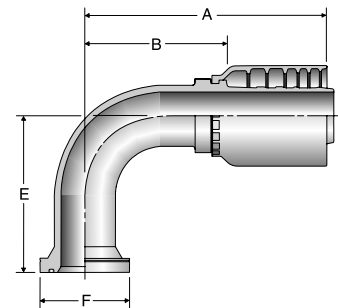

1XAS6

Caterpillar® Flange Head

# Part Number	Flange inch	Hose I.D. inch	A		F	B	
			inch	mm	inch	inch	mm
1XAS6-32-32	2	2	8.21	208,6	3-1/8	4.77	121

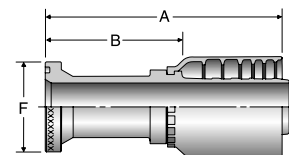

1JSS6

Female Seal-Lok - Swivel - Long

ISO 12151-1-SWSB

# Part Number	Thread inch	Hose I.D. inch	A		H	W	B	
			inch	mm	inch	inch	inch	mm
1JSS6-32-32	2-1/2X12	2	6.46	164,2	2.5	2-7/8	3.02	76,7

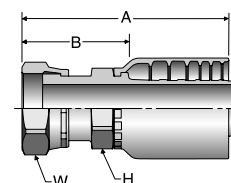





A

B

C

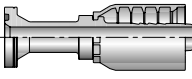
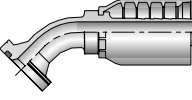
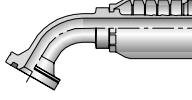
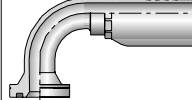
D

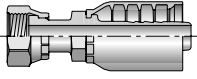
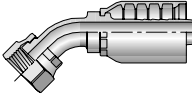
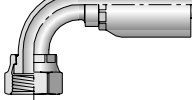
E

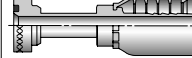
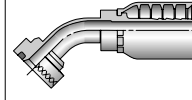
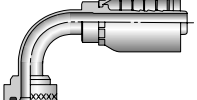
 <p>Code 62 Flange</p>	<p>16A79 B-122</p>  <p><i>Flange</i></p>	<p>16F79 B-122</p>  <p><i>45° Elbow</i></p>	<p>16G79 B-122</p>  <p><i>60° Elbow</i></p>	<p>16N79 B-123</p>  <p><i>90° Elbow</i></p>	 <p>Seal-Lok® (O-Ring Face Seal)</p>
<p>1JS79 B-123</p>  <p><i>Female - Swivel Long</i></p>	<p>1J779 B-123</p>  <p><i>Female - Swivel 45° Elbow</i></p>	<p>1J979 B-124</p>  <p><i>Female - Swivel 90° Elbow - Short</i></p>	 <p>Flange Head</p>	<p>1XA79 B-124</p>  <p><i>Flange Head</i></p>	<p>1XF79 B-124</p>  <p><i>45° Elbow</i></p>
<p>1XN79 B-124</p>  <p><i>90° Elbow</i></p>					

A

B

C

D

E

A

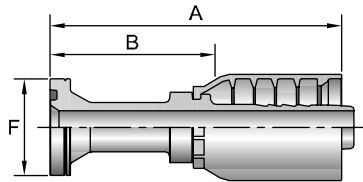

16A79

SAE Code 62 Flange Head
ISO 12151-3 - S - S

# Part Number	Flange inch	Hose I.D. inch	A		F		B	
			inch	mm	inch	inch	inch	mm
16A79-12-12	3/4	3/4	4.90	124	1-5/8	2.84	72	
16A79-16-12	1	3/4	3.88	99	1-7/8	1.82	46	
16A79-16-16	1	1	5.48	139	1-7/8	3.31	84	
16A79-20-16	1-1/4	1	4.28	109	2-1/8	2.11	54	
16A79-20-20	1-1/4	1-1/4	6.09	155	2-1/8	3.41	87	
16A79-24-24	1-1/2	1-1/2	7.11	181	1-1/2	4.07	103	

B

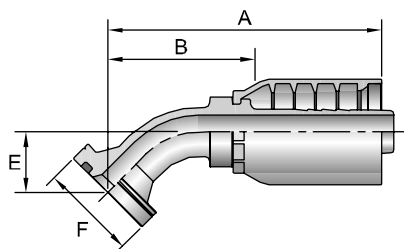

16F79

SAE Code 62 Flange Head - 45° Elbow

ISO 12151-3 - E45S - S (1 Piece: ISO 12151-3 - E45M - S)

# Part Number	Flange inch	Hose I.D. inch	A		E		F		B	
			inch	mm	inch	mm	inch	inch	inch	mm
16F79-12-12	3/4	3/4	4.61	117	1.02	26	1-5/8	2.55	65	
16F79-16-16	1	1	5.33	135	1.26	32	1-7/8	3.16	80	
16F79-16-20	1	1-1/4	6.25	159	1.50	38	1-7/8	3.57	91	
16F79-20-16	1-1/4	1	5.33	135	1.26	32	2-1/8	3.16	80	
16F79-20-20	1-1/4	1-1/4	6.77	172	1.50	38	2-1/8	4.09	104	
16F79-24-24	1-1/2	1-1/2	7.96	202	1.73	44	2-1/2	4.07	103	

C

D

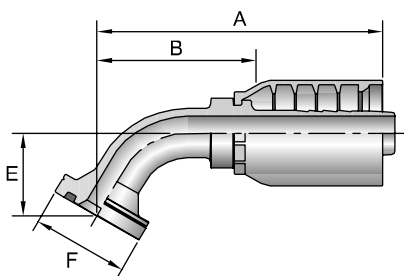

16G79

SAE Code 62 Flange Head - 60° Elbow

ISO 12151-3 - E60S - S (1 Piece: ISO 12151-3 - E60M - S)

# Part Number	Flange inch	Hose I.D. inch	A		E		F		B	
			inch	mm	inch	mm	inch	inch	inch	mm
16G79-16-16	1	1	6.18	157	1.73	44	1-7/8	4.01	102	

See Accessories Section for O-Rings and Flange Kits.

16N79

SAE Code 62 Flange Head - 90° Elbow

ISO 12151-3 - E90S - S (1 Piece: ISO 12151-3 - E90M - S)

# Part Number	Flange inch	Hose I.D. inch	A		E		F		B	
			inch	mm	inch	mm	inch	inch	inch	mm
16N79-12-12	3/4	3/4	4.27	108	2.28	58	1-5/8	2.21	56	
16N79-16-12	1	3/4	4.27	108	2.28	58	1-7/8	2.21	56	
16N79-16-16	1	1	4.95	126	2.76	70	1-7/8	2.78	71	
16N79-20-16	1-1/4	1	4.95	126	2.76	70	2-1/8	2.78	71	
16N79-20-20	1-1/4	1-1/4	6.31	160	3.54	90	2-1/8	3.63	92	
16N79-24-24	1-1/2	1-1/2	7.50	190	4.09	104	2-1/2	4.46	113	

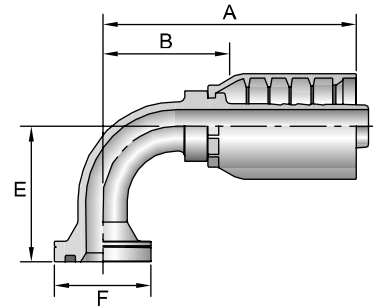

1JS79

Female Seal-Lok® - Swivel - Long

ISO 12151-1 - SWSB

# Part Number	Thread inch	Hose I.D. inch	A		H inch	W inch	B	
			inch	mm			inch	mm
1JS79-12-12	3/4	1-3/16x12	3.99	101	1-1/8	1-3/8	1.93	49
1JS79-16-12	1	1-7/16x12	4.26	108	1-3/8	1-5/8	2.20	56
1JS79-16-16	1	1-7/16x12	4.45	113	1-3/8	1-5/8	2.28	58
1JS79-20-16	1-1/4	1-11/16x12	4.32	110	1-3/4	1-7/8	2.15	55
1JS79-20-20	1-1/4	1-11/16x12	5.00	127	1-3/4	1-7/8	2.32	59
1JS79-24-24	1-1/2	2x12	5.28	134	2	2-1/4	2.24	57

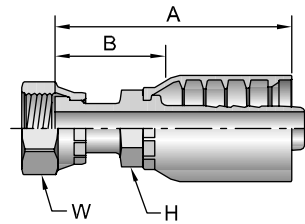

⚠ Refer to Pressure Rating of Hose End Connections chart on page E-43.

1J779

Female Seal-Lok® - Swivel - 45° Elbow

ISO 12151-1 - SWE45

# Part Number	Thread inch	Hose I.D. inch	A		E		W inch	B	
			inch	mm	inch	mm		inch	mm
1J779-12-12	3/4	1-3/16x12	4.40	112	0.83	21	1-3/8	2.34	59
1J779-16-16	1	1-7/16x12	5.01	127	0.94	24	1-5/8	2.84	72
1J779-20-20	1-1/4	1-11/16x12	6.15	156	1.00	25	1-7/8	3.49	89

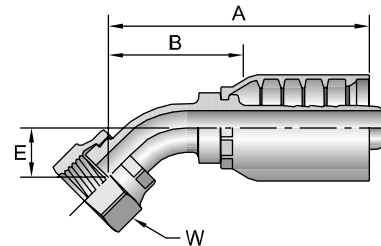

⚠ Refer to Pressure Rating of Hose End Connections chart on page E-43.

See Accessories Section for O-Rings and Flange Kits.

A

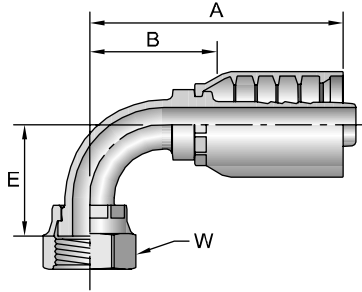

1J979

Female Seal-Lok® - Swivel - 90° Elbow - Short Drop
ISO - 12151-1 - SWES90

# Part Number	Thread		Hose I.D. inch	A		E		W inch	B	
	inch	inch		inch	mm	inch	mm		inch	mm
1J979-12-12	3/4	1-3/16x12	3/4	4.27	108	1.88	48	1-3/8	2.21	56
1J979-16-16	1	1-7/16x12	1	4.95	126	2.21	56	1-5/8	2.78	71
1J979-20-20	1-1/4	1-11/16x12	1-1/4	6.20	157	2.52	64	1-7/8	3.52	89

⚠ Refer to Pressure Rating of Hose End Connections chart on page E-43

B

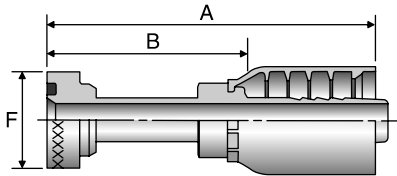

1XA79

Caterpillar® Flange Head

# Part Number	Flange inch	Hose I.D. inch	A		F inch	B	
			inch	mm		inch	mm
1XA79-12-12	3/4	3/4	4.89	124	1-5/8	2.83	72
1XA79-16-16	1	1	5.75	146	1-7/8	3.59	91
1XA79-20-16	1-1/4	1	4.32	110	2-1/8	2.15	55
1XA79-20-20	1-1/4	1-1/4	6.25	159	2-1/8	3.57	91
1XA79-24-24	1-1/2	1-1/2	7.17	182	2-1/2	4.13	105

C

1XF79

Caterpillar® Flange Head - 45° Elbow

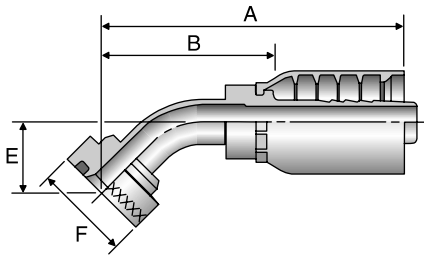

# Part Number	Flange inch	Hose I.D. inch	A		E		F inch	B	
			inch	mm	inch	mm		inch	mm
1XF79-12-12	3/4	3/4	4.80	122	1.22	31	1-5/8	2.74	70
1XF79-16-16	1	1	5.49	139	1.42	36	1-7/8	3.32	84
1XF79-20-16	1-1/4	1	5.49	139	1.42	36	2-1/8	3.32	84
1XF79-20-20	1-1/4	1-1/4	6.72	171	1.44	37	2-1/8	4.04	103

D

E

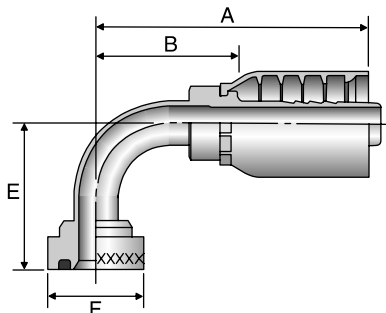

1XN79

Caterpillar® Flange Head - 90° Elbow

# Part Number	Flange inch	Hose I.D. inch	A		E		F inch	B	
			inch	mm	inch	mm		inch	mm
1XN79-12-12	3/4	3/4	4.27	108	2.48	63	1-5/8	2.21	56
1XN79-16-16	1	1	4.94	125	2.91	74	1-7/8	2.78	71
1XN79-20-16	1-1/4	1	4.94	125	2.91	74	2-1/8	2.78	71
1XN79-20-20	1-1/4	1-1/4	6.31	160	3.70	94	2-1/8	3.63	92
1XN79-24-24	1-1/2	1-1/2	7.50	191	4.16	106	2-1/2	4.46	113

See Accessories Section for O-Rings and Flange Kits.











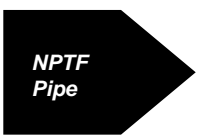
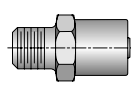
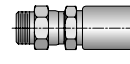
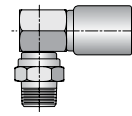
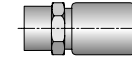
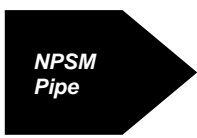
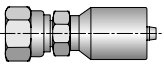
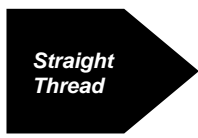
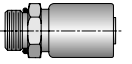
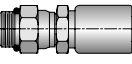
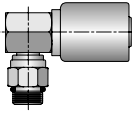

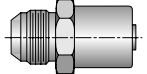
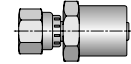
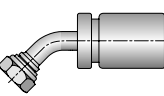
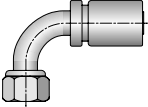
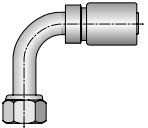
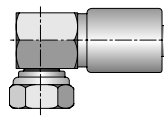

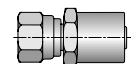
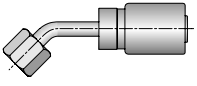
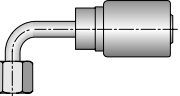

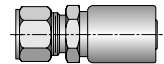
A

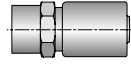
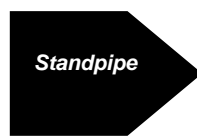
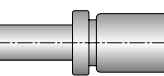
B

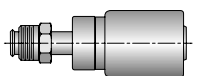
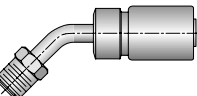
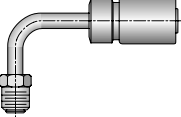
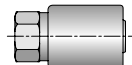
C

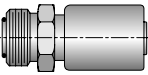
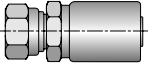
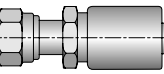
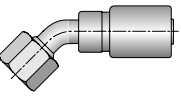
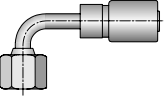
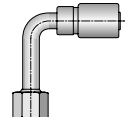
D

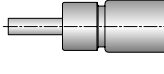
E

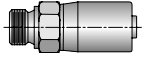
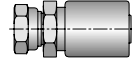
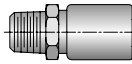
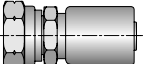
A	 NPTF Pipe	101HY B-127  <i>Male - Rigid</i>	113HY B-127  <i>Male - Swivel</i>	11LHY B-128  <i>Male - Swivel 90° Elbow</i>	102HY B-128  <i>Female - Rigid</i>	 NPSM Pipe
	107HY B-128  <i>Female - Swivel (60° Cone)</i>	 Straight Thread	105HY B-129  <i>Male - Rigid</i>	10GHY B-129  <i>Male - Swivel</i>	10LHY B-130  <i>Swivel - Swivel 90° Elbow</i>	 JIC 37°
103HY B-130  <i>Male - Rigid</i>	106HY B-131  <i>Female - Swivel</i>	137HY B-132  <i>Female - Swivel 45° Elbow - Short</i>	139HY B-132  <i>Female - Swivel 90° Elbow - Short</i>	141HY B-133  <i>Female - Swivel 90° Elbow - Long</i>	193HY B-133  <i>Female - Swivel 90° Elbow - Block</i>	
 SAE 45°	108HY B-133  <i>Female - Swivel</i>	177HY B-134  <i>Female - Swivel 45° Elbow</i>	179HY B-134  <i>Female - Swivel 90° Elbow</i>	 Flareless	111HY B-134  <i>Male - Rigid</i>	
 Grease Connection	1GJHY B-134  <i>Female - Rigid</i>	 Standpipe	134HY B-135  <i>Male Standpipe Rigid</i>	 Inverted Flare	128HY B-135  <i>Male - Swivel</i>	
167HY B-135  <i>Male - Swivel 45° Elbow</i>	169HY B-136  <i>Male - Swivel 90° Elbow</i>	129HY B-136  <i>Female - Rigid</i>	 Seal-Lok® (O-Ring Face Seal)	1J0HY B-136  <i>Male - Rigid w/O-Ring</i>	1JCHY B-136  <i>Female - Swivel Short</i>	
1JSHY B-137  <i>Female - Swivel Long</i>	1J7HY B-137  <i>Female - Swivel 45° Elbow</i>	1J9HY B-138  <i>Female - Swivel 90° Elbow - Short</i>	1J1HY B-138  <i>Female - Swivel 90° Elbow - Long</i>	 Metric L & S	1D0HY B-139  <i>Male - Rigid</i>	
13DHY B-139  <i>Male Standpipe Rigid</i>	 BSP	1D9HY B-139  <i>Male - Rigid</i>	1GUHY B-140  <i>Female - Swivel</i>	1UTHY B-140  <i>Male - Rigid</i>	1XUHY B-140  <i>Female - Metric Swivel</i>	

101HY Male NPTF Pipe - Rigid

# Part Number	Thread inch	Hose I.D. inch	A		H inch	B		Additional Material Stainless Steel (C303)
			inch	mm		inch	mm	
101HY-2-4	1/8x27	1/4	2.34	59	5/8	1.00	25	
101HY-4-4	1/4x18	1/4	2.53	64	9/16	1.19	30	
101HY-4-5	1/4x18	5/16	2.56	65	11/16	1.22	31	
101HY-4-6	1/4x18	3/8	2.55	65	11/16	1.19	30	
101HY-6-4	3/8x18	1/4	2.53	64	3/4	1.19	30	
101HY-6-5	3/8x18	5/16	2.56	65	3/4	1.22	31	
101HY-6-6	3/8x18	3/8	2.55	65	3/4	1.19	30	•
101HY-6-8	3/8x18	1/2	2.72	69	7/8	1.38	35	
101HY-8-4	1/2x14	1/4	2.72	69	7/8	1.38	35	
101HY-8-6	1/2x14	3/8	2.73	69	7/8	1.38	35	
101HY-8-7	1/2x14	13/32	2.73	69	7/8	1.38	35	
101HY-8-8	1/2x14	1/2	2.91	74	7/8	1.41	40	•
101HY-8-10	1/2x14	5/8	2.94	75	1-1/8	1.59	40	
101HY-8-12	1/2x14	3/4	3.08	78	1-1/4	1.50	38	
101HY-12-8	3/4x14	1/2	2.91	74	1-1/16	1.56	40	
101HY-12-10	3/4x14	5/8	2.98	76	1-1/8	1.59	40	
101HY-12-12	3/4x14	3/4	3.08	78	1-1/4	1.50	38	•
101HY-12-16	3/4x14	1	3.23	82	1-3/8	1.63	41	
101HY-16-12	1x11-1/2	3/4	3.27	83	1-3/8	1.69	43	
101HY-16-14	1x11-1/2	7/8	3.27	83	1-3/8	1.78	43	
101HY-16-16	1x11-1/2	1	3.42	87	1-3/8	1.81	46	•
101HY-20-20	1-1/4x11-1/2	1-1/4	3.84	98	1-3/4	2.00	51	

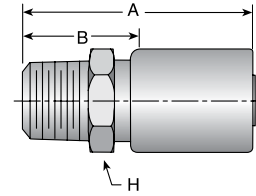

Stainless steel fittings must be assembled with Karrykrimp 2, Phastkrimp, Superkrimp or Parkrimp 2. See CrimpSource for more information.

113HY Male NPTF Pipe - Swivel

# Part Number	Thread inch	Hose I.D. inch	A		H inch	W inch	B	
			inch	mm			inch	mm
113HY-2-4	1/8x27	1/4	2.97	75	9/16	5/8	1.63	41
113HY-4-4	1/4x18	1/4	3.06	78	9/16	5/8	1.72	44
113HY-4-6	1/4x18	3/8	3.17	81	11/16	11/16	1.81	46
113HY-6-4	3/8x18	1/4	3.13	80	5/8	11/16	1.78	45
113HY-6-6	3/8x18	3/8	3.11	79	11/16	11/16	1.75	44
113HY-6-8	3/8x18	1/2	3.31	84	7/8	7/8	1.97	50
113HY-8-6	1/2x14	3/8	3.38	86	7/8	7/8	2.03	52
113HY-8-8	1/2x14	1/2	3.50	89	7/8	7/8	2.16	55
113HY-12-12	3/4x14	3/4	3.95	100	1-1/4	1-1/4	2.38	60
113HY-16-16	1x11-1/2	1	4.23	107	1-1/2	1-1/2	2.63	67

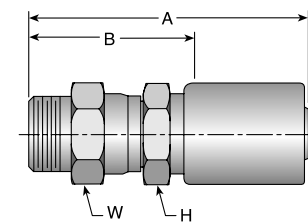

Fitting allows minor movement under pressure to relieve stress on hose but is not to be used for continuous swiveling. See Technical Section for Pressure Limitations.

A

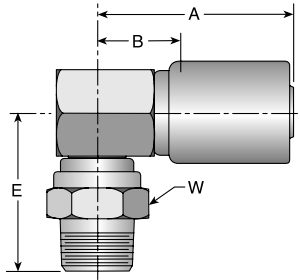

11LHY

Male NPTF Pipe - Swivel - 90° Elbow

# Part Number	Thread inch	Hose I.D. inch	A		E		W inch	B	
			inch	mm	inch	mm		inch	mm
11LHY-2-4	1/8x27	1/4	2.31	59	1.50	38	5/8	0.97	25
11LHY-4-4	1/4x18	1/4	2.31	59	1.69	43	11/16	0.97	25
11LHY-4-6	1/4x18	3/8	2.33	59	1.69	43	11/16	0.97	25
11LHY-6-4	3/8x18	1/4	2.31	59	1.63	41	11/16	0.97	25
11LHY-6-6	3/8x8	3/8	2.33	59	1.63	41	11/16	0.97	25
11LHY-8-6	1/2x14	3/8	2.73	69	1.88	48	7/8	0.97	25
11LHY-8-8	1/2x14	1/2	3.00	76	1.93	49	7/8	1.09	28

B

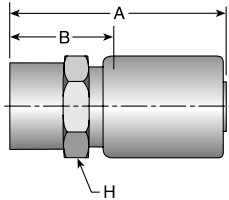

102HY

Female NPTF Pipe - Rigid

# Part Number	Thread inch	Hose I.D. inch	A		H inch	B	
			inch	mm		inch	mm
102HY-2-4	1/8x27	1/4	2.34	59	5/8	1.00	25
102HY-4-4	1/4x18	1/4	2.47	63	11/16	1.13	29
102HY-4-6	1/4x18	3/8	2.48	63	11/16	1.13	29
102HY-6-4	3/8x18	1/4	2.47	63	7/8	1.13	29
102HY-6-6	3/8x18	3/8	2.48	63	7/8	1.13	29
102HY-8-6	1/2x14	3/8	2.75	70	1	1.41	36
102HY-8-8	1/2x14	1/2	2.84	72	1	1.50	38
102HY-12-12	3/4x14	3/4	2.83	72	1-1/4	1.25	32
102HY-16-16	1x11-1/2	1	3.27	83	1-1/2	1.66	42

C

D

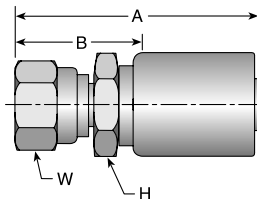

107HY

Female NPSM Pipe - Swivel - (60° Cone)

# Part Number	Thread inch	Hose I.D. inch	A		H inch	W inch	B	
			inch	mm			inch	mm
107HY-4-4	1/4x18	1/4	2.66	68	9/16	11/16	1.31	33
107HY-6-4	3/8x18	1/4	2.72	69	3/4	7/8	1.38	35
107HY-6-6	3/8x18	3/8	2.55	65	3/4	7/8	1.19	30
107HY-8-8	1/2x14	1/2	2.91	74	1	1	1.56	40
107HY-12-8	3/4x14	1/2	3.05	77	1-1/4	1-1/4	1.69	43
107HY-12-12	3/4x14	3/4	3.22	82	1-1/4	1-1/4	1.66	42
107HY-16-16	1x11-1/2	1	3.39	86	1-3/8	1-1/2	1.78	45

E

105HY

Male SAE Straight Thread with O-Ring - Rigid

# Part Number	Thread inch	Hose I.D. inch	A		H inch	B	
			inch	mm		inch	mm
105HY-4-4	7/16x20	1/4	2.33	59	9/16	0.97	25
105HY-5-4	1/2x20	1/4	2.33	59	5/8	0.97	25
105HY-6-4	9/16x18	1/4	2.42	61	11/16	1.06	27
105HY-6-6	9/16x18	3/8	2.38	60	11/16	1.03	26
105HY-8-6	3/4x16	3/8	2.42	61	7/8	1.06	27
105HY-8-8	3/4x16	1/2	2.59	66	7/8	1.25	32
105HY-10-6	7/8x14	3/8	2.55	65	1	1.19	30
105HY-10-8	7/8x14	1/2	2.66	68	1	1.31	33
105HY-10-10	7/8x14	5/8	2.80	71	1-1/8	1.41	36
105HY-12-8	1-1/16x12	1/2	2.81	71	1-1/4	1.47	37
105HY-12-10	1-1/16x12	5/8	2.83	72	1-1/4	1.44	37
105HY-12-12	1-1/16x12	3/4	2.92	74	1-1/4	1.34	34
105HY-16-12	1-5/16x12	3/4	2.92	74	1-1/2	1.34	34
105HY-16-16	1-5/16x12	1	3.08	78	1-1/2	1.47	37

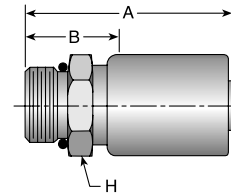

10GHY

Male SAE Straight Thread with O-Ring - Swivel

# Part Number	Thread inch	Hose I.D. inch	A		H inch	W inch	B	
			inch	mm			inch	mm
10GHY-4-4	7/16x20	1/4	3.00	76	9/16	5/8	1.66	42
10GHY-5-4	1/2x20	1/4	3.00	76	9/16	5/8	1.66	42
10GHY-6-4	9/16x18	1/4	3.16	80	5/8	11/16	1.81	46
10GHY-6-6	9/16x18	3/8	3.14	80	11/16	11/16	1.78	45
10GHY-8-6	3/4x16	3/8	3.24	82	13/16	7/8	1.88	48
10GHY-8-8	3/4x16	1/2	3.36	85	7/8	7/8	2.00	51
10GHY-10-8	7/8x14	1/2	3.44	87	1	1	2.09	53
10GHY-12-8	1-1/16x12	1/2	3.66	93	1-1/4	1-1/4	2.31	59
10GHY-12-12	1-1/16x12	3/4	3.89	99	1-1/4	1-1/4	2.31	59
10GHY-16-16	1-5/16x12	1	3.95	100	1-3/8	1-1/2	2.34	59

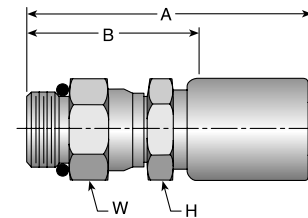

Fitting allows minor movement under pressure to relieve stress on hose but is not to be used on extensive or continuous swiveling.

O-Ring not compatible with Phosphate Ester fluids.

A

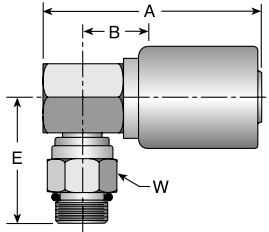

10LHY

Male SAE Straight Thread with O-Ring - Swivel - 90° Elbow

# Part Number	Thread inch	Hose I.D. inch	A		E		W		B	
			inch	mm	inch	mm	inch	inch	mm	
10LHY-4-4	7/16x20	1/4	2.31	59	1.63	41	11/16	0.97	25	
10LHY-6-4	9/16x18	1/4	2.31	59	1.66	42	7/8	0.97	25	
10LHY-6-6	9/16x18	3/8	2.33	59	1.66	42	11/16	0.97	25	
10LHY-8-4	3/4x16	1/4	2.31	59	1.75	44	7/8	0.94	24	
10LHY-8-6	3/4x16	3/8	2.33	59	1.73	44	7/8	0.97	25	
10LHY-8-8	3/4x16	1/2	3.00	76	1.80	46	7/8	1.09	28	
10LHY-10-8	7/8x14	1/2	3.00	76	1.88	48	1	1.09	28	
10LHY-12-12	1-1/16x12	3/4	2.77	70	2.23	57	1-1/4	1.19	30	

Fitting allows minor movement under pressure to relieve stress on hose but is not to be used on extensive or continuous swiveling.

B

103HY

Male JIC 37° - Rigid

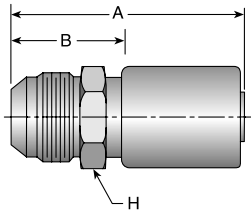

# Part Number	Thread inch	Hose I.D. inch	A		H inch	B	
			inch	mm		inch	mm
103HY-4-4	7/16x20	1/4	2.52	64	5/8	1.19	30
103HY-5-4	1/2x20	1/4	2.52	64	5/8	1.19	30
103HY-6-4	9/16x18	1/4	2.53	64	11/16	1.19	30
103HY-6-5	9/16x18	5/16	2.56	65	11/16	1.22	31
103HY-6-6	9/16x18	3/8	2.54	65	11/16	1.19	30
103HY-6-8	9/16x18	1/2	2.72	69	7/8	1.38	35
103HY-8-6	3/4x16	3/8	2.64	67	13/16	1.28	33
103HY-8-8	3/4x16	1/2	2.81	71	7/8	1.47	37
103HY-10-6	7/8x14	3/8	2.81	71	1	1.47	37
103HY-10-8	7/8x14	1/2	2.91	74	1	1.56	40
103HY-10-10	7/8x14	5/8	2.98	76	1-1/8	1.59	40
103HY-10-12	7/8x14	3/4	3.08	78	1-1/4	1.50	38
103HY-12-8	1-1/16x12	1/2	3.02	77	1-1/8	1.66	42
103HY-12-10	1-1/16x12	5/8	3.09	78	1-1/8	1.72	44
103HY-12-12	1-1/16x12	3/4	3.19	81	1-1/4	1.63	41
103HY-14-12	1-3/16x12	3/4	3.19	81	1-1/4	1.63	41
103HY-16-12	1-5/16x12	3/4	3.23	82	1-3/8	1.66	42
103HY-16-16	1-5/16x12	1	3.39	86	1-3/8	1.78	45
103HY-20-16	1-5/8x12	1	3.44	87	1-3/4	1.81	46
103HY-20-20	1-5/8x12	1-1/4	3.83	97	1-3/4	2.00	51

C

D

E

106HY
Female JIC 37° - Swivel

# Part Number	Thread inch	Hose I.D. inch	A		H	W	B		Additional Material Stainless Steel (C303)
			inch	mm	inch	inch	inch	mm	
106HY-3-4	3/8x24	1/4	2.58	66	9/16	1/2	1.22	31	
106HY-4-4	7/16x20	1/4	2.60	66	9/16	9/16	1.25	32	•
106HY-4-6	7/16x20	3/8	2.67	68	3/4	9/16	1.31	33	
106HY-5-4	1/2x20	1/4	2.65	67	9/16	5/8	1.31	33	
106HY-5-5	1/2x20	5/16	2.69	68	5/8	5/8	1.34	34	
106HY-5-6	1/2x20	3/8	2.73	69	3/4	5/8	1.38	35	
106HY-6-4	9/16x18	1/4	2.67	68	9/16	11/16	1.31	33	
106HY-6-5	9/16x18	5/16	2.70	69	5/8	11/16	1.34	34	
106HY-6-6	9/16x18	3/8	2.69	68	11/16	11/16	1.34	34	•
106HY-8-6	3/4x16	3/8	2.72	69	7/8	7/8	1.38	35	•
106HY-8-8	3/4x16	1/2	2.90	74	7/8	7/8	1.41	40	•
106HY-8-10	3/4x16	5/8	2.98	76	1-1/8	7/8	1.59	40	
106HY-8-12	3/4x16	3/4	3.08	78	1-1/4	7/8	1.53	39	
106HY-10-6	7/8x14	3/8	2.81	71	7/8	1	1.47	37	
106HY-10-8	7/8x14	1/2	2.98	76	1	1	1.63	41	
106HY-10-10	7/8x14	5/8	3.06	78	1-1/8	1	1.69	43	
106HY-10-12	7/8x14	3/4	3.16	80	1-1/4	1	1.59	40	
106HY-12-6	1-1/16x12	3/8	3.00	76	1-1/8	1-1/4	1.66	42	
106HY-12-8	1-1/16x12	1/2	3.05	77	1-1/8	1-1/4	1.69	43	
106HY-12-10	1-1/16x12	5/8	3.12	79	1-1/8	1-1/4	1.75	44	
106HY-12-12	1-1/16x12	3/4	3.22	82	1-1/4	1-1/4	1.66	42	•
106HY-12-16	1-1/16x12	1	3.38	86	1-3/8	1-1/4	1.75	44	
106HY-14-12	1-3/16x12	3/4	3.23	82	1-1/4	1 3/8	1.66	42	
106HY-16-12	1-5/16x12	3/4	3.30	84	1-3/8	1-1/2	1.72	44	
106HY-16-14	1-5/16x12	7/8	3.30	84	1-3/8	1-1/2	1.72	44	
106HY-16-16	1-5/16x12	1	3.45	88	1-3/8	1-1/2	1.84	47	•
106HY-16-20	1-5/16x12	1-1/4	3.84	98	1-3/4	1-1/2	2.00	51	
106HY-20-16	1-5/8x12	1	3.70	94	1-3/4	2	2.09	53	
106HY-20-20	1-5/8x12	1-1/4	4.09	104	2	2	2.25	57	

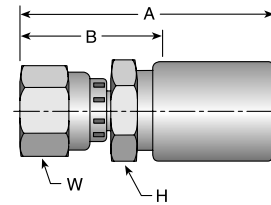

Stainless steel fittings must be assembled with Karrykrimp 2, PHastkrimp, Superkrimp or Parkrimp 2. See CrimpSource for more information.

A

B

C

D

E

137HY

Female JIC 37° - Swivel - 45° Elbow - Short Drop

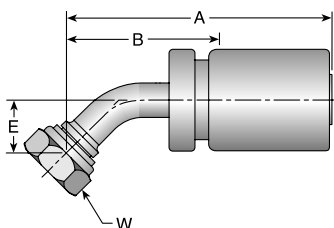

# Part Number	Thread inch	Hose I.D. inch	A		E		W		B	
			inch	mm	inch	mm	inch	inch	mm	
137HY-4-4	7/16x20	1/4	2.59	66	0.39	10	9/16	1.32	34	
137HY-5-4	1/2x20	1/4	3.27	83	0.36	9	5/8	1.91	49	
137HY-6-4	9/16x18	1/4	2.70	69	0.43	10	3/4	1.43	36	
137HY-6-5	9/16x18	5/16	3.34	85	0.39	11	11/16	2.00	51	
137HY-6-6	9/16x18	3/8	2.72	69	0.43	11	11/16	1.44	37	
137HY-8-6	3/4x16	3/8	2.88	73	0.58	15	7/8	1.60	41	
137HY-8-8	3/4x16	1/2	3.10	79	0.59	15	7/8	1.81	46	
137HY-10-8	7/8x14	1/2	3.20	81	0.63	16	1	1.91	49	
137HY-10-10	7/8x14	5/8	3.29	84	0.63	16	1	1.93	49	
137HY-12-10	1-1/16x12	5/8	3.94	100	0.77	20	1-1/8	2.56	65	
137HY-12-12	1-1/16x12	3/4	3.82	97	0.83	21	1-1/4	2.29	58	
137HY-16-12	1-5/16x12	3/4	4.35	110	0.89	23	1-1/2	2.78	71	
137HY-16-16	1-5/16x12	1	4.31	109	0.89	23	1-1/2	2.69	68	

139HY

Female JIC 37° - Swivel - 90° Elbow - Short Drop

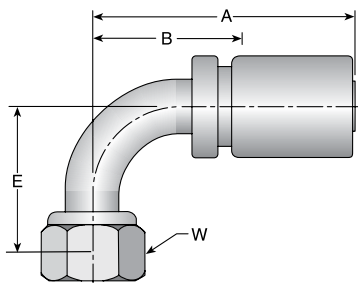

# Part Number	Thread inch	Hose I.D. inch	A		E		W		B	
			inch	mm	inch	mm	inch	inch	mm	
139HY-4-4	7/16x20	1/4	2.40	61	0.83	21	9/16	1.13	29	
139HY-5-4	1/2x20	1/4	2.50	64	0.83	21	5/8	1.23	31	
139HY-6-4	9/16x18	1/4	2.65	67	0.91	23	3/4	1.38	35	
139HY-6-5	9/16x18	5/16	3.25	83	0.86	22	11/16	1.91	49	
139HY-6-6	9/16x18	3/8	2.57	65	0.91	23	11/16	1.29	33	
139HY-6-8	9/16x18	1/2	3.41	87	0.86	22	11/16	2.06	52	
139HY-8-6	3/4x16	3/8	2.64	67	1.14	29	7/8	1.37	35	
139HY-8-8	3/4x16	1/2	2.85	72	1.14	29	7/8	1.56	40	
139HY-10-8	7/8x14	1/2	3.01	76	1.26	32	1	1.72	44	
139HY-10-10	7/8x14	5/8	3.09	78	1.26	32	1	1.73	44	
139HY-10-12	7/8x14	3/4	3.25	83	1.23	31	1	1.69	43	
139HY-12-8	1-1/16x12	1/2	3.61	92	1.83	46	1-1/4	2.25	57	
139HY-12-10	1-1/16x12	5/8	3.61	92	1.89	48	1-1/4	2.25	57	
139HY-12-12	1-1/16x12	3/4	3.68	93	1.89	48	1-1/4	2.15	55	
139HY-16-12	1-5/16x12	3/4	4.33	110	2.14	54	1-1/2	2.78	71	
139HY-16-16	1-5/16x12	1	4.31	109	2.31	59	1-1/2	2.69	68	

141HY

Female JIC 37° - Swivel - 90° Elbow - Long Drop

# Part Number	Thread inch	Hose I.D. inch	A		E		W inch	B	
			inch	mm	inch	mm		inch	mm
141HY-4-4	7/16x20	1/4	2.68	68	1.81	46	9/16	1.41	36
141HY-5-4	1/2x20	1/4	3.16	80	1.77	45	5/8	1.81	46
141HY-6-4	9/16x18	1/4	2.89	73	2.13	54	11/16	1.62	41
141HY-6-6	9/16x18	3/8	2.76	70	2.13	54	11/16	1.49	39
141HY-8-6	3/4x16	3/8	2.85	72	2.52	64	7/8	1.58	40
141HY-8-8	3/4x16	1/2	2.89	73	2.52	64	7/8	1.60	41
141HY-10-8	7/8x14	1/2	3.01	76	2.76	70	1	1.72	44
141HY-12-12	1-1/16x12	3/4	3.59	91	3.73	95	1-1/4	2.03	52
141HY-16-16	1-5/16x12	1	4.56	116	4.33	110	1-1/2	2.94	75

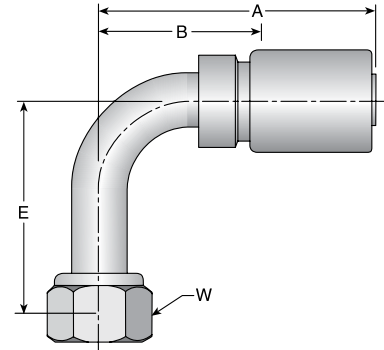

193HY

Female JIC 37° - Swivel - 90° Elbow - (Block Type)

# Part Number	Thread inch	Hose I.D. inch	A		E		W inch	B	
			inch	mm	inch	mm		inch	mm
193HY-6-6	9/16x18	3/8	2.33	59	0.78	20	11/16	0.97	25
193HY-8-6	3/4x16	3/8	2.33	59	0.82	21	7/8	0.97	25
193HY-8-8	3/4x16	1/2	3.00	76	0.85	22	7/8	1.09	28
193HY-12-12	1-1/16x12	3/4	3.33	85	0.99	25	1-1/4	1.19	30

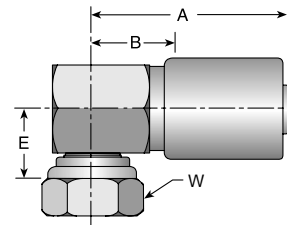

108HY

Female SAE 45° - Swivel

# Part Number	Thread inch	Hose I.D. inch	A		H inch	W inch	B	
			inch	mm			inch	mm
108HY-4-4	7/16x20	1/4	2.60	66	9/16	9/16	1.26	32
108HY-5-4	1/2x20	1/4	2.66	68	9/16	5/8	1.31	33
108HY-5-5	1/2x20	5/16	2.68	68	5/8	5/8	1.34	34
108HY-6-4	5/8x18	1/4	2.73	69	11/16	3/4	1.38	35
108HY-6-5	5/8x18	5/16	2.76	70	5/8	3/4	1.41	36
108HY-6-6	5/8x18	3/8	2.75	70	11/16	3/4	1.41	36
108HY-8-6	3/4x16	3/8	2.73	69	13/16	7/8	1.38	35
108HY-8-8	3/4x16	1/2	2.90	74	7/8	7/8	1.56	40
108HY-8-12	3/4x16	3/4	3.17	81	1-1/4	7/8	1.59	40
108HY-10-8	7/8x14	1/2	2.98	76	1	1	1.63	41
108HY-10-10	7/8x14	5/8	3.06	78	1-1/8	1	1.69	43
108HY-12-10	1-1/16x12	5/8	3.33	85	1-1/8	1-1/4	1.94	49
108HY-12-12	1-1/16x12	3/4	3.41	87	1-1/4	1-1/4	1.84	47

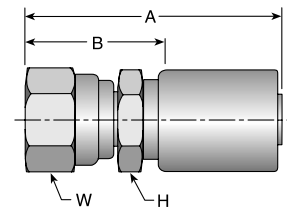

A

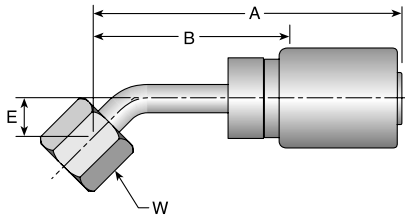

177HY

Female SAE 45° - Swivel - 45° Elbow

# Part Number	Thread inch	Hose I.D. inch	A		E		W		B	
			inch	mm	inch	mm	inch	inch	mm	
177HY-6-6	5/8x18	3/8	3.33	85	0.39	10	3/4	1.97	50	
177HY-12-12	1-1/16x14	3/4	4.03	102	0.77	20	1-1/4	2.44	62	

B

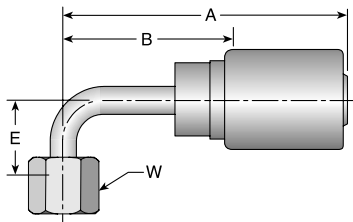

179HY

Female SAE 45° - Swivel - 90° Elbow

# Part Number	Thread inch	Hose I.D. inch	A		E		W		B	
			inch	mm	inch	mm	inch	inch	mm	
179HY-6-5	5/8x18	5/16	3.25	83	0.86	22	3/4	1.91	49	
179HY-6-6	5/8x18	3/8	3.23	82	0.86	22	3/4	1.88	48	
179HY-12-12	1-1/16x14	3/4	3.98	101	1.83	46	1-1/4	2.39	61	

C

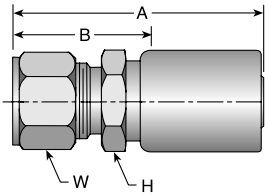

111HY

Male Ferulok Flareless - Rigid
(24° Cone w/Nut and Ferrule)

# Part Number	Thread inch	Hose I.D. inch	A		H		W		B	
			inch	mm	inch	inch	inch	inch	mm	
111HY-4-4	7/16x20	1/4	2.42	61	9/16	9/16	1.06	27		
111HY-4-6	7/16x20	3/8	2.44	62	3/4	9/16	1.09	28		
111HY-5-6	1/2x20	3/8	2.44	62	3/4	5/8	1.09	28		
111HY-6-4	9/16x18	1/4	2.44	62	5/8	11/16	1.09	28		
111HY-6-6	9/16x18	3/8	2.45	62	11/16	11/16	1.09	28		
111HY-8-6	3/4x16	3/8	2.61	66	7/8	7/8	1.25	32		
111HY-8-8	3/4x16	1/2	2.72	69	7/8	7/8	1.38	35		
111HY-10-8	7/8x14	1/2	2.78	71	1	1	1.44	37		
111HY-12-12	1-1/16x12	3/4	3.02	77	1-1/4	1-1/4	1.44	37		

The Parker Ferrule-Fix fitting makes it possible to salvage the bent tube section from a hose assembly for quick, easy on the job repairs. For additional information see Ferrule-Fix installation instructions in the Technical Section.

D

E

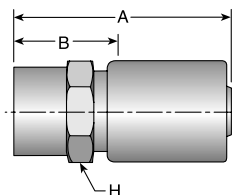



1GJHY

Female Grease Connection - SPL - PTF Taper
Thread - Rigid - 1/2x27

# Part Number	Thread inch	Hose I.D. inch	A		H		B	
			inch	mm	inch	inch	mm	
1GJHY-8-4	1/2x27	1/4	2.41	61	3/4	1.06	27	

134HY

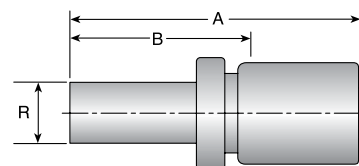

Male Standpipe - Rigid - (Inch Size Tube O.D.)

# Part Number			A		B	
	R inch	Hose I.D. inch	inch	mm	inch	mm
134HY-6-6	3/8	3/8	3.17	81	1.81	46
134HY-8-6	1/2	3/8	3.33	85	1.97	50
134HY-12-12	3/4	3/4	3.89	99	2.31	59



128HY

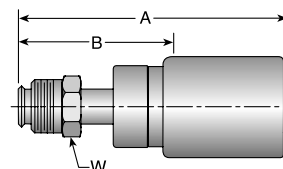

Male Inverted SAE 45° - Swivel

# Part Number			A			B	
	Thread inch	Hose I.D. inch	inch	mm	W inch	inch	mm
128HY-3-4	3/8x24	1/4	3.09	78	3/8	1.75	44
128HY-4-4	7/16x24	1/4	3.28	83	7/16	1.94	49
128HY-5-4	1/2x20	1/4	3.34	85	1/2	2.00	51
128HY-5-6	1/2x20	3/8	3.17	81	1/2	1.81	46
128HY-6-5	5/8x18	5/16	3.75	95	5/8	2.41	61
128HY-6-6	5/8x18	3/8	3.73	95	5/8	2.38	60
128HY-7-6	11/16x18	3/8	3.73	95	11/16	2.38	60
128HY-8-6	3/4x18	3/8	3.42	87	3/4	2.06	52
128HY-8-8	3/4x18	1/2	3.66	93	3/4	2.31	59



167HY

Male Inverted SAE 45° - Swivel - 45° Elbow

# Part Number			A		E			B	
	Thread inch	Hose I.D. inch	inch	mm	inch	mm	W inch	inch	mm
167HY-4-4	7/16x24	1/4	3.31	84	0.78	20	7/16	1.97	50
167HY-5-4	1/2x20	1/4	3.55	90	0.88	22	1/2	2.19	56
167HY-5-6	1/2x20	3/8	3.38	86	0.88	22	1/2	2.03	52
167HY-6-6	5/8x18	3/8	4.16	106	0.94	24	5/8	2.81	71
167HY-8-8	3/4x18	1/2	4.22	107	1.06	27	3/4	2.88	73

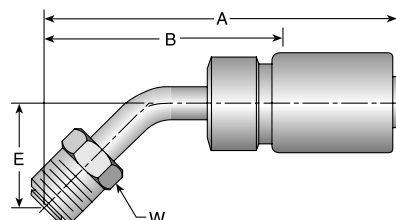

A

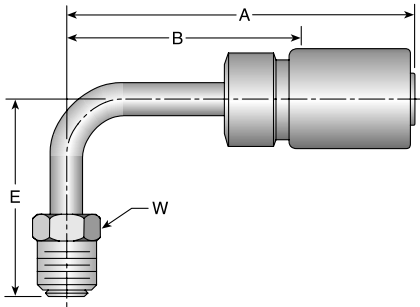

169HY

Male Inverted SAE 45° - Swivel - 90° Elbow

# Part Number	Thread inch	Hose I.D. inch	A		E		W inch	B	
			inch	mm	inch	mm		inch	mm
169HY-3-4	3/8x24	1/4	3.09	78	1.38	35	3/8	1.75	44
169HY-4-4	7/16x24	1/4	3.28	83	1.47	37	7/16	1.94	49
169HY-4-6	7/16x24	3/8	3.11	79	1.47	37	7/16	1.75	44
169HY-5-4	1/2x20	1/4	3.52	89	1.66	42	1/2	2.16	55
169HY-5-6	1/2x20	3/8	3.34	85	1.66	42	1/2	2.00	51
169HY-6-5	5/8x18	5/16	4.05	103	1.69	43	5/8	2.69	68
169HY-6-6	5/8x18	3/8	4.03	102	1.69	43	5/8	2.69	68
169HY-7-6	11/16x18	3/8	4.16	106	1.69	43	11/16	2.81	71
169HY-8-8	3/4x18	1/2	4.09	104	1.88	48	3/4	2.75	70

B

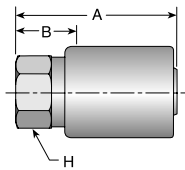

129HY

Female Inverted SAE 45° - Rigid

# Part Number	Thread inch	Hose I.D. inch	A		H inch	B	
			inch	mm		inch	mm
129HY-5-4	1/2x20	1/4	2.25	57	5/8	0.91	23
129HY-6-6	5/8x18	3/8	2.25	57	7/8	0.91	23

C

1J0HY

Male Seal-Lok® - Rigid - (with O-Ring)
ISO 1215-1 - S

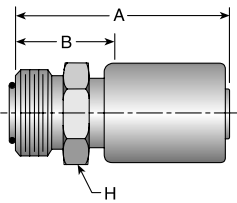

# Part Number	Thread inch	Hose I.D. inch	A		H inch	B	
			inch	mm		inch	mm
1J0HY-4-4	9/16x18	1/4	2.36	60	5/8	1.00	25
1J0HY-6-6	11/16x16	3/8	2.49	63	3/4	1.13	29
1J0HY-8-8	13/16x16	1/2	2.69	68	7/8	1.34	34
1J0HY-12-8	1-3/16x12	1/2	2.91	74	1-1/4	1.56	40

D

1JCHY

Female Seal-Lok® - Swivel - Short
ISO 12151-1 - SWSA

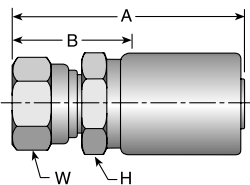

# Part Number	Thread inch	Hose I.D. inch	A		H inch	W inch	B	
			inch	mm			inch	mm
1JCHY-4-4	9/16x18	1/4	2.61	66	9/16	11/16	0.94	24
1JCHY-6-6	11/16x16	3/8	2.69	68	11/16	13/16	0.94	24
1JCHY-8-8	13/16x16	1/2	2.91	74	7/8	15/16	1.13	29
1JCHY-12-12	1-3/16x12	3/4	3.31	84	1-1/4	1-3/8	1.13	29

E

See Accessories Section for O-Rings.

1JSHY

Female Seal-Lok® - Swivel - Long
ISO 12151-1 - SWSB

# Part Number	Thread inch	Hose I.D. inch	A		H inch	W inch	B	
			inch	mm			inch	mm
1JSHY-4-4	9/16x18	1/4	2.59	66	9/16	11/16	1.25	32
1JSHY-6-4	11/16x16	1/4	2.67	68	5/8	13/16	1.31	33
1JSHY-6-5	11/16x16	5/16	2.70	69	5/8	13/16	1.34	34
1JSHY-6-6	11/16x16	3/8	2.75	70	11/16	13/16	1.34	34
1JSHY-8-6	13/16x16	3/8	2.84	72	7/8	15/16	1.50	38
1JSHY-8-8	13/16x16	1/2	2.95	75	7/8	15/16	1.59	40
1JSHY-10-8	1x14	1/2	3.16	80	15/16	1-1/8	1.81	46
1JSHY-10-10	1x14	5/8	3.17	81	1-1/8	1-1/8	1.78	45
1JSHY-10-12	1x14	3/4	3.27	83	1-1/4	1-1/8	1.69	43
1JSHY-12-10	1-3/16x12	5/8	3.20	81	1-1/8	1-3/8	1.81	46
1JSHY-12-12	1-3/16x12	3/4	3.30	84	1-1/4	1-3/8	1.72	44
1JSHY-16-12	1-7/16x12	3/4	3.44	87	1-3/8	1-5/8	1.88	48
1JSHY-16-16	1-7/16x12	1	3.59	91	1-3/8	1-5/8	1.97	50
1JSHY-20-16	1-11/16x12	1	3.47	88	1-5/8	1-7/8	1.75	59
1JSHY-20-20	1-11/16x12	1-1/4	3.98	101	1-3/4	1-7/8	2.16	55

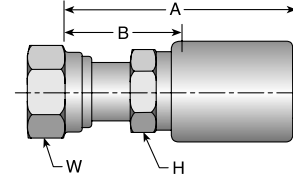

1J7HY

Female Seal-Lok® - Swivel - 45° Elbow
ISO 12151-1 - SWE45

# Part Number	Thread inch	Hose I.D. inch	A		E		W inch	B	
			inch	mm	inch	mm		inch	mm
1J7HY-4-4	9/16x18	1/4	2.59	66	0.39	10	11/16	1.32	34
1J7HY-6-4	11/16x16	1/4	2.70	69	0.43	11	13/16	1.43	36
1J7HY-6-6	11/16x16	3/8	2.72	69	0.43	11	13/16	1.44	37
1J7HY-6-8	11/16x16	1/2	3.41	87	0.44	11	13/16	2.06	52
1J7HY-8-4	13/16x16	1/4	2.95	75	0.59	15	15/16	1.68	43
1J7HY-8-6	13/16x16	3/8	2.89	73	0.59	15	15/16	1.62	41
1J7HY-8-8	13/16x16	1/2	3.10	79	0.59	15	15/16	1.81	46
1J7HY-10-8	1x14	1/2	3.20	81	0.63	16	1-1/8	1.91	49
1J7HY-10-10	1x14	5/8	3.29	84	0.63	16	1-1/8	1.93	49
1J7HY-10-12	1x14	3/4	3.69	94	0.69	18	1-1/8	2.13	54
1J7HY-12-10	1-3/16x12	5/8	3.74	104	0.83	21	1-3/8	2.38	60
1J7HY-12-12	1-3/16x12	3/4	3.82	97	0.83	21	1-3/8	2.29	58
1J7HY-16-12	1-7/16x12	3/4	4.39	112	0.97	25	1-5/8	2.84	72
1J7HY-16-16	1-7/16x12	1	4.55	116	0.97	25	1-5/8	2.94	75

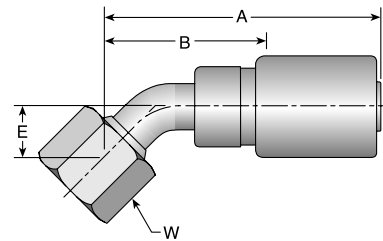

See Accessories Section for O-Rings.

1J9HY

Female Seal-Lok® - Swivel - 90° Elbow - Short Drop
ISO 12151-1 - SWES90

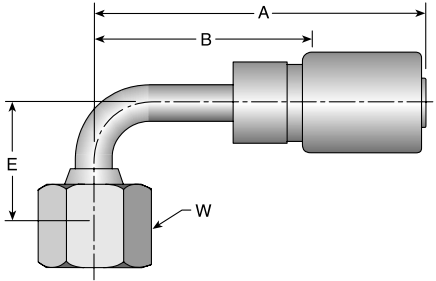

# Part Number	Thread inch	Hose I.D. inch	A		E		W		B	
			inch	mm	inch	mm	inch	inch	mm	
1J9HY-4-4	9/16x18	1/4	2.40	61	0.83	21	11/16	1.13	29	
1J9HY-4-6	9/16x18	3/8	3.08	78	0.83	21	11/16	1.72	44	
1J9HY-6-4	11/16x16	1/4	2.65	67	0.91	23	13/16	1.38	35	
1J9HY-6-5	11/16x16	5/16	3/14	80		23	13/16	1.72	44	
1J9HY-6-6	11/16x16	3/8	2.57	65	0.91	23	13/16	1.29	33	
1J9HY-6-8	11/16x16	1/2	2.77	70	0.91	23	13/16	1.48	38	
1J9HY-8-6	13/16x16	3/8	2.64	67	1.14	29	15/16	1.37	35	
1J9HY-8-8	13/16x16	1/2	2.85	72	1.14	29	15/16	1.56	40	
1J9HY-10-8	1x14	1/2	3.01	76	1.26	32	1-1/8	1.72	44	
1J9HY-10-10	1x14	5/8	3.09	78	1.26	32	1-1/8	1.73	44	
1J9HY-10-12	1x14	3/4	3.52	89	1.33	34	1-1/8	1.97	50	
1J9HY-12-8	1-3/16x12	1/2	3.84	98	1.89	48	1-3/8	2.39	61	
1J9HY-12-10	1-3/16x12	5/8	3.61	92	1.89	48	1-3/8	2.25	57	
1J9HY-12-12	1-3/16x12	3/4	3.68	93	1.89	48	1-3/8	2.15	55	
1J9HY-16-12	1-7/16x12	3/4	4.27	108	2.25	57	1-5/8	2.69	68	
1J9HY-16-16	1-7/16x12	1	4.45	113	2.25	57	1-5/8	2.84	72	
1J9HY-20-16	1-11/16x12	1	4.77	121	2.51	64	1-7/8	3.16	80	

1J1HY

Female Seal-Lok® - Swivel - 90° Elbow - Long Drop
ISO 12151-1 - SWEL90

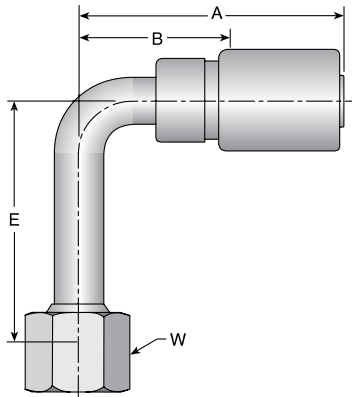

# Part Number	Thread inch	Hose I.D. inch	A		E		W		B	
			inch	mm	inch	mm	inch	inch	mm	
1J1HY-4-4	9/16x18	1/4	2.68	68	1.81	46	11/16	1.41	36	
1J1HY-6-4	11/16x16	1/4	2.89	73	2.13	54	13/16	1.62	41	
1J1HY-6-6	11/16x16	3/8	2.76	70	2.13	54	13/16	1.49	38	
1J1HY-8-6	13/16x16	3/8	2.85	72	2.52	64	15/16	1.58	40	
1J1HY-8-8	13/16x16	1/2	2.94	75	2.52	64	15/16	1.65	42	
1J1HY-10-8	1x14	1/2	3.01	76	2.76	70	1-1/8	1.72	44	
1J1HY-10-10	1x14	5/8	3.42	87	2.76	70	1-1/8	2.03	52	
1J1HY-12-12	1-3/16x12	3/4	3.68	93	3.78	96	1-3/8	2.15	55	
1J1HY-16-16	1-7/16x12	1	4.45	113	4.50	114	1-5/8	2.84	72	

See Accessories Section for O-Rings.

1D0HY

Male Metric L - Rigid - (24° Cone)

ISO 12151-2

# Part Number	Thread		Hose I.D. inch	A		H mm	B	
	mm	M		inch	mm		inch	mm
1D0HY-6-4	6	M12x1.5	1/4	2.36	60	14	1.00	25
1D0HY-8-4	8	M14x1.5	1/4	2.36	60	17	1.00	25
1D0HY-10-4	10	M16x1.5	1/4	2.40	61	19	1.03	26
1D0HY-10-6	10	M16x1.5	3/8	2.42	61	19	1.06	27
1D0HY-12-6	12	M18x1.5	3/8	2.42	61	22	1.06	27
1D0HY-15-6	15	M22x1.5	3/8	2.52	64	24	1.16	29
1D0HY-15-8	15	M22x1.5	1/2	2.63	67	24	1.28	33
1D0HY-18-10	18	M26x1.5	5/8	2.71	69	27	1.31	33

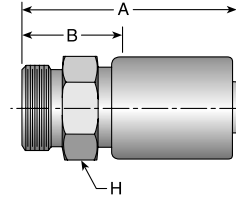

13DHY

Male Standpipe Metric S - Rigid

End Connection per ISO 8434-1-SDS

# Part Number	R	Hose I.D. inch	A		B	
	mm		inch	mm	inch	mm
13DHY-16-8	16	1/2	3.53	90	2.16	55
13DHY-30-16	30	1	4.15	105	2.53	64

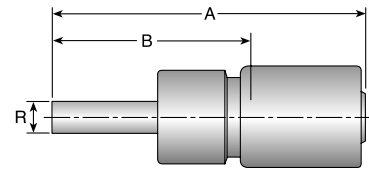

1D9HY

Male BSP Parallel Pipe - Rigid - (60° Cone)

ISO 228-1

# Part Number	Thread	Hose I.D. inch	A		H inch	B	
	inch		inch	mm		inch	mm
1D9HY-4-4	1/4x19	1/4	2.40	61	13/16	1.03	26
1D9HY-6-6	3/8x19	3/8	2.55	65	7/8	1.19	30
1D9HY-8-6	1/2x14	3/8	2.65	67	1-1/16	1.28	33
1D9HY-8-8	1/2x14	1/2	2.83	72	1-1/16	1.47	37

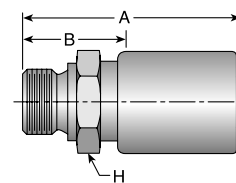

When used in a port, a bonded seal must be used. See Accessories Section for more information.

Metric L: Mates with EO "L" Series Fittings.
Metric S: Mates with EO "S" Series Fittings.

A

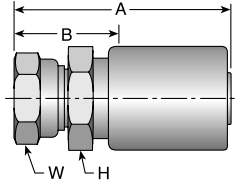

1GUHY

Female BSP Parallel Pipe - Swivel - (60° Cone)

ISO 228-1

# Part Number	Thread inch	Hose I.D. inch	A		H	W	B	
			inch	mm	inch	inch	inch	mm
1GUHY-4-4	1/4x19	1/4	2.62	67	9/16	11/16	1.28	33
1GUHY-6-4	3/8x19	1/4	2.69	68	3/4	7/8	1.34	34
1GUHY-6-6	3/8x19	3/8	2.70	69	3/4	7/8	1.34	34
1GUHY-8-6	1/2x14	3/8	2.84	72	7/8	1	1.50	38
1GUHY-8-8	1/2x14	1/2	3.02	77	7/8	1	1.66	42
1GUHY-12-12	3/4x14	3/4	3.25	83	1-1/4	1-1/4	1.69	43
1GUHY-16-16	1x11	1	3.45	88	1-3/8	1-1/2	1.84	47

B

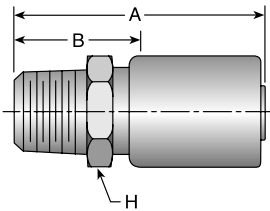

1UTHY

Male BSP Taper Pipe - Rigid - (60° Cone)

# Part Number	Thread inch	Hose I.D. inch	A		H	B	
			inch	mm	inch	inch	mm
1UTHY-2-4	1/8x28	1/4	2.34	59	9/16	1.00	25
1UTHY-4-4	1/4x19	1/4	2.53	64	9/16	1.19	30

C

1XUHY



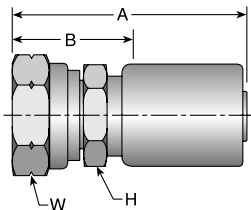







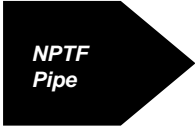
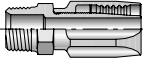

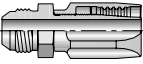
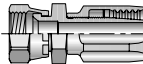
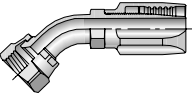
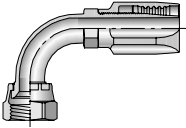

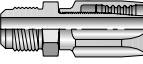
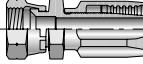
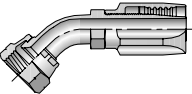
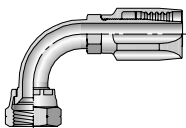
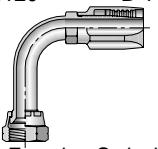

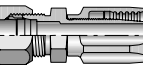

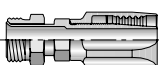
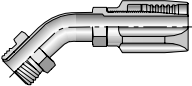
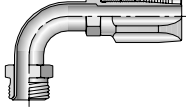
Female Metric Swivel - (30° Flare)

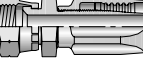

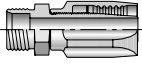
# Part Number	Thread mm		Hose I.D. inch	A		H	W	B	
				inch	mm	mm	mm	inch	mm
1XUHY-24-8	24	M24x1.5	1/2	3.14	80	22	30	1.72	44
1XUHY-24-10	24	M24x1.5	5/8	3.22	82	30	30	1.84	47
1XUHY-30-12	30	M30x1.5	3/4	3.31	84	32	38	1.75	44
1XUHY-33-16	33	M33x1.5	1	3.62	92	36	41	2.00	51

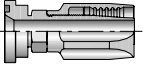
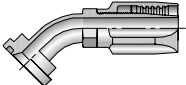
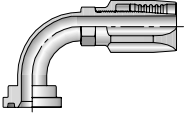
D

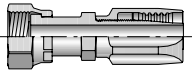
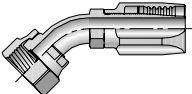
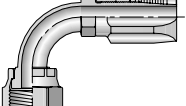
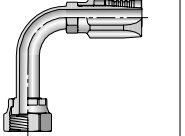
E

 NPTF Pipe	20120 B-142  <i>Male - Rigid</i>	 JIC 37°	20320 B-142  <i>Male - Rigid</i>	20620 B-143  <i>Female - Swivel</i>	23720 B-143  <i>Female - Swivel 45° Elbow - Short</i>
23920 B-144  <i>Female - Swivel 90° Elbow - Short</i>	24120 B-144  <i>Female - Swivel 90° Elbow - Long</i>	 SAE 45°	20420 B-144  <i>Male - Rigid</i>	20820 B-145  <i>Female - Swivel</i>	27720 B-145  <i>Female - Swivel 45° Elbow</i>
27920 B-145  <i>Female - Swivel 90° Elbow</i>	28120 B-146  <i>Female - Swivel 90° Elbow - Long</i>	 Flareless	21120 B-146  <i>Male - Rigid</i>	 Inverted Flare	22820 B-146  <i>Male - Swivel</i>
26720 B-146  <i>Male - Swivel 45° Elbow</i>	26920 B-147  <i>Male - Swivel 90° Elbow</i>	 PTT 30°	23220 B-147  <i>Female - Swivel</i>	 Compression	26120 B-147  <i>Male (without Nut or Sleeve)</i>
 Code 61 Flange	21520 B-147  <i>Flange</i>	21720 B-148  <i>45° Elbow</i>	21920 B-148  <i>90° Elbow</i>	 Seal-Lok® (O-Ring Face Seal)	2JS20 B-148  <i>Female - Swivel Long</i>
2J720 B-148  <i>Female - Swivel 45° Elbow</i>	2J920 B-149  <i>Female - Swivel 90° Elbow - Short</i>	2J120 B-149  <i>Female - Swivel 90° Elbow - Long</i>	 Assembly Instructions	20 Series Assembly Instructions B-150	

A

B

C

D

E

20120 Male NPTF Pipe - Rigid

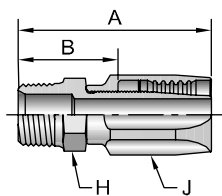

# Part Number	Thread inch	Hose I.D. inch	A		H		J		B		Additional Material Brass (B)
			inch	mm	inch	inch	inch	mm			
20120-2-4	1/8x27	3/16	1.72	44	7/16	5/8	0.94	24			
20120-2-5	1/8x27	1/4	1.82	46	1/2	11/16	0.99	25			
20120-4-4	1/4x18	3/16	1.93	49	9/16	5/8	1.15	29			
20120-4-5	1/4x18	1/4	2.01	51	9/16	11/16	1.18	30			
20120-4-6	1/4x18	5/16	2.11	54	9/16	13/16	1.19	30			
20120-6-6	3/8x18	5/16	2.20	56	3/4	13/16	1.28	33			
20120-6-8	3/8x18	13/32	2.48	63	3/4	15/16	1.39	35			
20120-8-8	1/2x14	13/32	2.73	69	7/8	15/16	1.64	42			
20120-8-10	1/2x14	1/2	2.88	73	7/8	1-1/8	1.66	42			
20120-12-10	3/4x14	1/2	2.95	75	1-1/16	1-1/8	1.73	44			
20120-12-12	3/4x14	5/8	3.25	83	1-1/16	1-1/4	1.75	44			
20120-12-16	3/4x14	7/8	2.81	71	1-3/8	1-7/16	1.62	41			
20120-16-16	1x11-1/2	7/8	2.99	76	1-3/8	1-7/16	1.80	46	•		
20120-20-20	1-1/4x11-1/2	1-1/8	3.24	82	1-3/4	1-3/4	1.96	50	•		
20120-24-24	1-1/2x11-1/2	1-3/8	3.50	89	2	2	2.13	54	•		
20120-32-32	2 x11-1/2	1-13/16	4.05	103	2-1/2	2-1/2	2.31	59	•		

20320 Male JIC 37° - Rigid

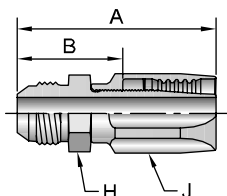

# Part Number	Thread inch		Hose I.D. inch	A		H		J		B	
	inch	mm		inch	mm	inch	inch	inch	mm		
20320-4-4	1/4	7/16x20	3/16	1.83	46	1/2	5/8	1.05	27		
20320-5-5	5/16	1/2x20	1/4	1.94	49	9/16	11/16	1.11	28		
20320-6-6	3/8	9/16x18	5/16	2.11	54	5/8	13/16	1.19	30		
20320-8-8	1/2	3/4x16	13/32	2.57	65	13/16	15/16	1.48	38		
20320-10-10	5/8	7/8x14	1/2	2.88	73	15/16	1-1/8	1.66	42		
20320-12-12	3/4	1-1/16x12	5/8	3.35	85	1-1/8	1-1/4	1.85	47		
20320-16-16	1	1-5/16x12	7/8	2.95	75	1-3/8	1-7/16	1.76	45		

20620

Female JIC 37° - Swivel

# Part Number	Thread		Hose I.D. inch	A		H inch	J inch	W inch	B		Additional Material Stainless Steel (C)
	inch	7/16x20		inch	mm				inch	mm	
20620-4-4	1/4	7/16x20	3/16	1.94	49	9/16	5/8	9/16	1.16	29	•
20620-4-5	1/4	7/16x20	1/4	2.04	52	9/16	11/16	9/16	1.21	31	
20620-5-5	5/16	1/2x20	1/4	2.12	54	5/8	11/16	5/8	1.29	33	
20620-6-5	3/8	9/16x18	1/4	2.19	56	11/16	11/16	11/16	1.36	35	
20620-6-6	3/8	9/16x18	5/16	2.32	59	11/16	13/16	11/16	1.40	36	•
20620-8-6	1/2	3/4x16	5/16	2.44	62	7/8	13/16	7/8	1.52	39	
20620-8-8	1/2	3/4x16	13/32	2.79	71	7/8	15/16	7/8	1.70	43	•
20620-8-10	1/2	3/4x16	1/2	2.99	76	7/8	1-1/8	7/8	1.77	45	
20620-10-8	5/8	7/8x14	13/32	2.94	75	7/8	15/16	1	1.85	47	
20620-10-10	5/8	7/8x14	1/2	3.10	79	1	1-1/8	1	1.88	48	•
20620-10-12	5/8	7/8x14	5/8	3.40	86	1	1-1/4	1	1.90	48	
20620-12-12	3/4	1-1/16x12	5/8	3.49	89	1-1/4	1-1/4	1-1/4	1.99	51	•
20620-16-16	1	1-5/16x12	7/8	3.20	81	1-1/2	1-7/16	1-1/2	2.01	51	•
20620-20-20	1-1/4	1-5/8x12	1-1/8	3.56	90	2	1-3/4	2	2.28	58	
20620-24-24	1-1/2	1-7/8x12	1-3/8	3.95	100	2-1/4	2	2-1/4	2.58	66	
20620-32-32	2	2-1/2x12	1-13/16	4.71	120	2-7/8	2-1/2	2-7/8	2.97	75	

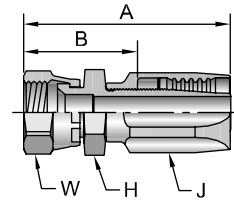

A

B

23720

Female JIC 37° - Swivel - 45° Elbow - Short Drop

# Part Number	Thread		Hose I.D. inch	A		E		H inch	J inch	W inch	B	
	inch	7/16x20		inch	mm	inch	mm				inch	mm
23720-4-4	1/4	7/16x20	3/16	2.08	53	0.33	8	3/8	5/8	9/16	1.30	33
23720-5-5	5/16	1/2x20	1/4	2.30	58	0.36	9	7/16	11/16	5/8	1.47	37
23720-6-6	3/8	9/16x18	5/16	2.45	62	0.39	10	1/2	13/16	11/16	1.53	39
23720-8-6	1/2	3/4x16	5/16	2.77	70	0.55	14	5/8	13/16	7/8	1.85	47
23720-10-10	5/8	7/8x14	1/2	3.36	85	0.65	17	3/4	1-1/8	1	2.14	54
23720-12-12	3/4	1-1/16x12	5/8	3.94	100	0.79	20	7/8	1-1/4	1-1/4	2.44	62
23720-16-16	1	1-5/16x12	7/8	3.73	95	0.90	23	1-1/8	1-7/16	1-1/2	2.54	65
23720-20-20	1-1/4	1-5/8x12	1-1/8	4.17	106	1.19	30	1-1/2	1-3/4	2	2.89	73

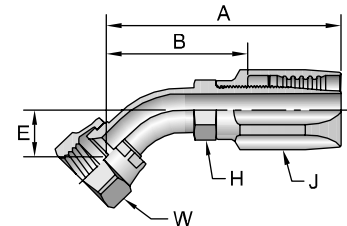

C

D

E

23920

Female JIC 37° - Swivel - 90° Elbow - Short Drop

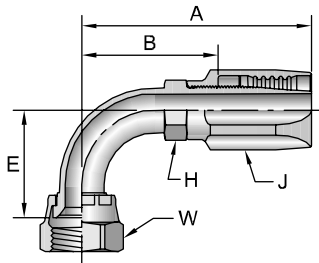

# Part Number	Thread		Hose I.D. inch	A		E		H inch	J inch	W inch	B	
	inch			inch	mm	inch	mm				inch	mm
23920-4-4	1/4	7/16x20	3/16	1.91	49	0.83	21	3/8	5/8	9/16	1.13	29
23920-5-5	5/16	1/2x20	1/4	2.30	58	0.77	20	7/16	11/16	5/8	1.47	37
23920-6-6	3/8	9/16x18	5/16	2.35	60	0.90	23	1/2	13/16	11/16	1.43	36
23920-8-8	1/2	3/4x16	13/32	2.88	73	1.09	28	5/8	15/16	7/8	1.79	45
23920-10-10	5/8	7/8x14	1/2	3.20	81	1.24	31	3/4	1-1/8	1	1.98	50
23920-12-12	3/4	1-1/16x12	5/8	3.86	98	1.82	46	7/8	1-1/4	1-1/4	2.36	60
23920-16-16	1	1-5/16x12	7/8	3.69	94	2.14	54	1-1/8	1-7/16	1-1/2	2.50	64
23920-20-20	1-1/4	1-5/8x12	1-1/8	4.01	102	2.59	66	1-1/2	1-3/4	2	2.73	69
23920-24-24	1-1/2	1-7/8x12	1-3/8	4.43	113	2.82	72	1-3/4	2	2-1/4	3.06	78

24120

Female JIC 37° - Swivel - 90° Elbow - Long Drop

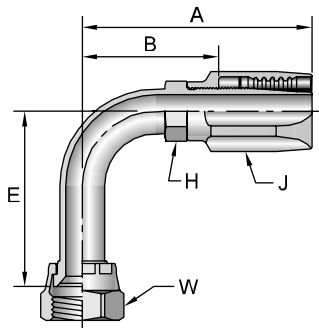

# Part Number	Thread		Hose I.D. inch	A		E		H inch	J inch	W inch	B	
	inch			inch	mm	inch	mm				inch	mm
24120-4-4	1/4	7/16x20	3/16	2.08	53	1.80	46	3/8	5/8	9/16	1.30	33
24120-6-6	3/8	9/16x18	5/16	2.34	59	2.18	55	1/2	13/16	11/16	1.42	36
24120-8-8	1/2	3/4x16	13/32	2.95	75	2.43	62	5/8	15/16	7/8	1.86	47
24120-10-10	5/8	7/8x14	1/2	3.26	83	2.58	66	3/4	1-1/8	1	2.04	52
24120-12-12	3/4	1-1/16x12	5/8	3.78	96	3.74	95	7/8	1-1/4	1-1/4	2.28	58

20420

Male SAE 45° - Rigid

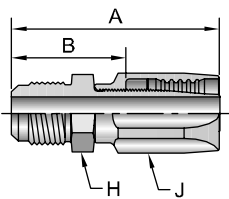

# Part Number	Thread		Hose I.D. inch	A		H inch	J inch	B	
	inch			inch	mm			inch	mm
20420-4-4	1/4	7/16x20	3/16	1.80	46	1/2	5/8	1.02	26
20420-5-5	5/16	1/2x20	1/4	1.94	49	9/16	11/16	1.11	28
20420-6-6	3/8	5/8x18	5/16	2.17	55	11/16	13/16	1.25	32
20420-8-8	1/2	3/4x16	13/32	2.67	68	13/16	15/16	1.58	40
20420-10-10	5/8	7/8x14	1/2	3.00	76	15/16	1-1/8	1.78	45
20420-12-12	3/4	1-1/16x14	5/8	3.50	89	1-1/8	1-1/4	2.00	51

20820

Female SAE 45° - Swivel

# Part Number	Thread		Hose I.D. inch	A		H inch	J inch	W inch	B	
	inch			inch	mm				inch	mm
20820-4-4	1/4	7/16x20	3/16	1.94	49	9/16	5/8	9/16	1.16	29
20820-4-5	1/4	7/16x20	1/4	2.04	52	9/16	11-16	9/16	1.21	31
20820-5-5	5/16	1/2x20	1/4	2.12	54	5/8	11-16	5/8	1.29	33
20820-6-6	3/8	5/8x18	5/16	2.36	60	3/4	13/16	3/4	1.44	37
20820-8-8	1/2	3/4x16	3/8	2.79	71	7/8	15/16	7/8	1.70	43
20820-8-10	1/2	3/4x16	1/2	2.99	76	7/8	1-1/8	7/8	1.77	45
20820-10-10	5/8	7/8x14	1/2	3.10	79	1	1-1/8	1	1.88	48
20820-12-12	3/4	1-1/16x14	5/8	3.49	89	1-1/4	1-1/4	1-1/4	1.99	51

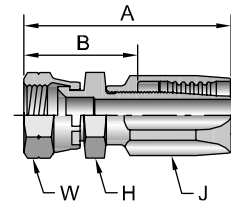

27720

Female SAE 45° - Swivel - 45° Elbow

# Part Number	Thread		Hose I.D. inch	A		E		H inch	J inch	W inch	B	
	inch			inch	mm	inch	mm				inch	mm
27720-6-6	3/8	5/8x18	5/16	2.45	62	0.39	10	1/2	13/16	3/4	1.53	39
27720-8-6	1/2	3/4x16	5/16	2.77	71	0.55	14	5/8	13/16	7/8	1.86	47
27720-8-8	1/2	3/4x16	13/32	3.09	78	0.55	14	5/8	15/16	7/8	2.00	51
27720-10-10	5/8	7/8x14	1/2	3.35	85	0.65	17	3/4	1-1/8	1	2.13	54

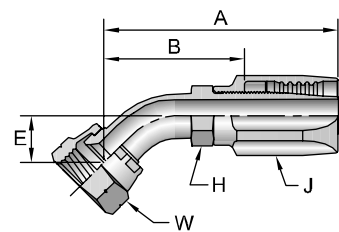

27920

Female SAE 45° - Swivel - 90° Elbow

# Part Number	Thread		Hose I.D. inch	A		E		H inch	J inch	W inch	B	
	inch			inch	mm	inch	mm				inch	mm
27920-4-4	1/4	7/16x20	3/16	1.91	49	0.83	21	3/8	5/8	9/16	1.13	29
27920-5-5	5/16	1/2x20	1/4	2.30	58	0.77	20	7/16	11/16	5/8	1.47	37
27920-6-6	3/8	5/8x18	5/16	2.33	59	0.85	22	1/2	13/16	3/4	1.41	36
27920-8-8	1/2	3/4x16	13/32	2.86	73	1.09	28	5/8	15/16	7/8	1.77	45
27920-10-10	5/8	7/8x14	1/2	3.20	81	1.24	31	3/4	1-1/8	1	1.98	50
27920-12-12	3/4	1-1/16x14	5/8	3.87	98	1.82	46	7/8	1-1/4	1-1/4	2.37	60

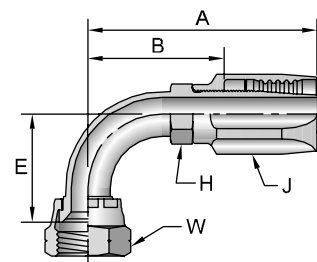

Notch in nut signifies 45° flare.

28120

Female SAE 45° - Swivel - 90° Elbow - Long Drop

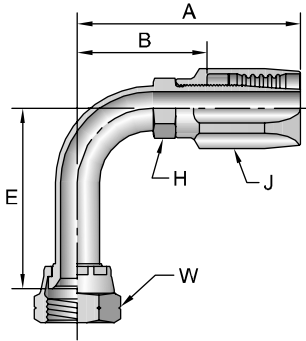

#	Thread	Hose I.D.	A		E		H	J	W	B	
Part Number	inch	inch	inch	mm	inch	mm	inch	inch	inch	inch	mm
28120-6-6	3/8 5/8x18	5/16	2.34	59	2.18	55	1/2	13/16	3/4	1.42	36
28120-8-8	1/2 3/4x16	13/32	2.95	75	2.43	62	5/8	15/16	7/8	1.86	47

Notch in nut signifies 45° flare.

21120

Male Ferrulok Flareless - Rigid (24° Cone with Nut and Ferrule)

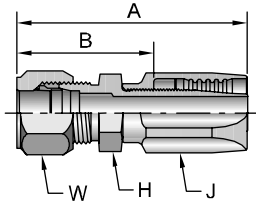

#	Thread	Hose I.D.	A		H	J	W	B	
Part Number	inch	inch	inch	mm	inch	inch	inch	inch	mm
21120-6-6	3/8 9/16x18	5/16	2.05	52	5/8	13/16	11/16	1.13	29
21120-8-8	1/2 3/4x16	13/32	2.52	64	13/16	15/16	7/8	1.43	36

The Parker Ferrule-Fix fitting makes it possible to salvage the bent tube section from a hose assembly for quick, easy on the job repairs. For additional information see Ferrule-Fix installation instructions in the Technical Section.

22820

Male Inverted SAE 45° - Swivel

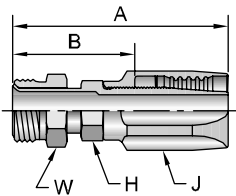

#	Thread	Hose I.D.	A		H	J	W	B	
Part Number	inch	inch	inch	mm	inch	inch	inch	inch	mm
22820-4-4	1/4 7/16x24	3/16	2.45	62	3/8	5/8	7/16	1.67	42
22820-5-5	5/16 1/2x20	1/4	2.70	69	7/16	11/16	1/2	1.87	47
22820-6-6	3/8 5/8x18	5/16	2.95	75	1/2	13/16	5/8	2.03	52
22820-8-8	1/2 3/4x18	13/32	3.36	85	5/8	15/16	3/4	2.27	58
22820-10-10	5/8 7/8x18	1/2	3.64	92	3/4	1-1/8	7/8	2.42	61

26720

Male Inverted SAE 45° - Swivel - 45° Elbow

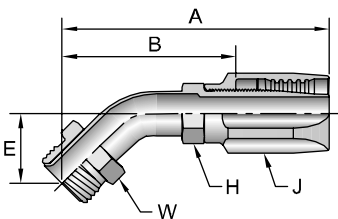

#	Thread	Hose I.D.	A		E		H	J	W	B	
Part Number	inch	inch	inch	mm	inch	mm	inch	inch	inch	inch	mm
26720-4-4	1/4 7/16x24	3/16	2.21	56	0.62	16	3/8	5/8	7/16	1.43	36
26720-5-5	5/16 1/2x20	1/4	2.44	62	0.70	18	7/16	11/16	1/2	1.61	41
26720-6-6	3/8 5/8x18	5/16	3.00	76	0.94	24	1/2	13/16	5/8	2.08	53
26720-8-8	1/2 3/4x18	13/32	3.51	89	1.09	28	5/8	15/16	3/4	2.42	61

26920

Male Inverted SAE 45° - Swivel - 90° Elbow

# Part Number	Thread		Hose I.D. inch	A		E		H inch	J inch	W inch	B	
	inch	7/16x24		inch	inch	mm	inch				mm	inch
26920-4-4	1/4	7/16x24	3/16	2.29	58	1.56	40	3/8	5/8	7/16	1.51	38
26920-5-5	5/16	1/2x20	1/4	2.55	65	1.65	42	7/16	11/16	1/2	1.72	44
26920-5-6	5/16	1/2x20	5/16	2.63	67	1.65	42	1/2	13/16	1/2	1.71	43
26920-6-6	3/8	5/8x18	5/16	2.67	68	1.69	43	1/2	13/16	5/8	1.75	44
26920-8-8	1/2	3/4x18	13/32	3.09	78	1.88	48	5/8	15/16	3/4	2.00	51

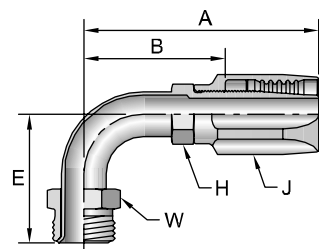

23220

Female PTT 30° - Swivel

# Part Number	Thread inch	Hose I.D. inch	A		H inch	J inch	W inch	B		
			inch	mm				inch	mm	
23220-16-16	1	1-5/16x14	7/8	2.98	76	1-1/2	1-7/16	1-1/2	1.79	45

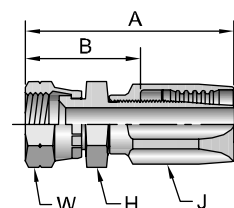

26120

Male SAE Compression Seat (without Nut or Sleeve)

# Part Number	Thread		Hose I.D. inch	A		H inch	J inch	B	
	inch	13/16x18		inch	mm			inch	mm
26120-10-10	5/8	13/16x18	1/2	2.64	67	7/8	1-1/8	1.42	36

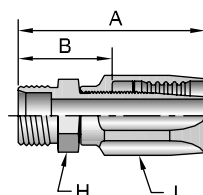

21520

SAE Code 61 Flange Head ISO 12151-3-S-L

# Part Number	Flange inch	Hose I.D. inch	A		F inch	H inch	J inch	B	
			inch	mm				inch	mm
21520-20-20	1-1/4	1-1/8	3.58	91	2	1-1/2	1-3/4	2.30	58
21520-40-40	2-1/2	2-3/8	5.22	133	3-5/16	2-3/4	3-1/8	3.41	87

See Accessories Section for O-Rings and Flange Kits.

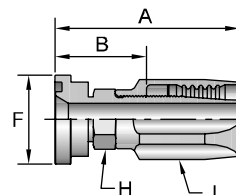

21720

SAE Code 61 Flange Head - 45° Elbow

ISO 12151-3- E45S - L (1 Piece: ISO 12151-3- E45M - L)

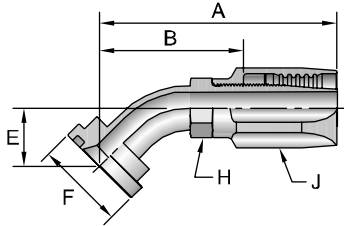

#			A		E					B	
Part Number	Flange inch	Hose I.D. inch	inch	mm	inch	mm	inch	inch	inch	inch	mm
21720-20-20	1-1/4	1-1/8	4.10	104	1.12	28	2	1-1/2	1-3/4	2.82	72
21720-40-40	2-1/2	2-3/8	5.83	148	1.41	36	3-3/8	2-3/4	3-1/8	4.02	102

21920

SAE Code 61 Flange Head - 90° Elbow

ISO 12151-3- E90S - L (1 Piece: ISO 12151-3- E90M - L)

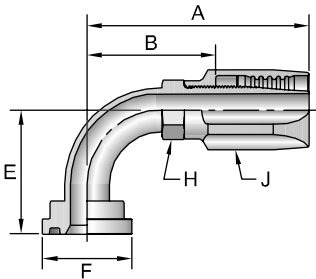

#			A		E					B	
Part Number	Flange inch	Hose I.D. inch	inch	mm	inch	mm	inch	inch	inch	inch	mm
21920-8-8	1/2	13/32	2.95	75	1.62	41	1-3/16	5/8	15/16	1.86	47
21920-32-32	2	1-13/16	5.44	138	3.19	81	2-13/16	2-1/4	2-1/2	3.70	94
21920-40-40	2-1/2	2-3/8	6.18	157	3.75	95	3-5/16	2-3/4	3-1/8	4.37	111

2JS20

Female Seal-Lok® - Swivel - Long

ISO 12151-1 - SWSB

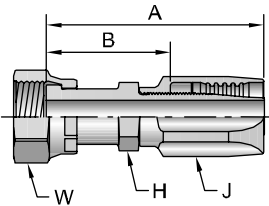

#			A					B		
Part Number	Thread inch	Hose I.D. inch	inch	mm	inch	inch	inch	inch	mm	
2JS20-4-4	1/4	9/16x18	3/16	2.07	53	9/16	5/8	11/16	1.29	33
2JS20-6-6	3/8	11/16x16	5/16	2.36	60	1/2	13/16	13/16	1.44	37
2JS20-8-8	1/2	13/16x16	13/32	2.92	74	5/8	15/16	15/16	1.83	46
2JS20-10-10	5/8	1x14	1/2	3.15	80	3/4	1-1/8	1-1/8	1.93	49
2JS20-12-12	3/4	1-3/16x12	5/8	3.66	93	1-1/8	1-1/4	1-3/8	2.16	55

2J720

Female Seal-Lok® - Swivel - 45° Elbow

ISO 12151-1 - SWE45

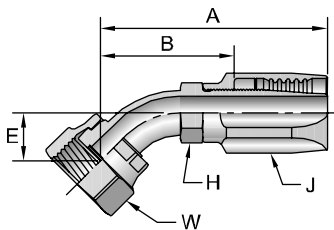

#			A		E					B		
Part Number	Thread inch	Hose I.D. inch	inch	mm	inch	mm	inch	inch	inch	inch	mm	
2J720-4-4	1/4	9/16x18	3/16	2.24	57	0.41	10	7/16	5/8	11/16	1.46	37
2J720-6-6	3/8	11/16x16	5/16	2.52	64	0.43	11	1/2	13/16	13/16	1.60	41
2J720-8-8	1/2	13/16x16	13/32	3.19	81	0.59	15	5/8	15/16	15/16	2.10	53
2J720-10-10	5/8	1x14	1/2	3.46	88	0.65	17	3/4	1-1/8	1-1/8	2.24	57

See Accessories Section for O-Rings and Flange Kits.

2J920

Female Seal-Lok® - Swivel 90° Elbow - Short Drop
ISO 12151-1 - SWE90

# Part Number	Thread		Hose I.D. inch	A		E		H inch	J inch	W inch	B	
	inch	inch		inch	mm	inch	mm				inch	mm
2J920-4-4	1/4	9/16x18	3/16	2.22	56	0.82	21	7/16	5/8	11/16	1.44	37
2J920-6-6	3/8	11/16x16	5/16	2.39	61	0.90	23	1/2	13/16	13/16	1.47	37
2J920-8-8	1/2	13/16x16	13/32	2.91	74	1.15	29	5/8	15/16	15/16	1.82	46
2J920-10-10	5/8	1x14	1/2	3.16	80	1.27	32	3/4	1-1/8	1-1/8	1.94	49
2J920-12-12	3/4	1-3/16x12	5/8	3.74	95	1.85	47	7/8	1-1/4	1-3/8	2.24	57

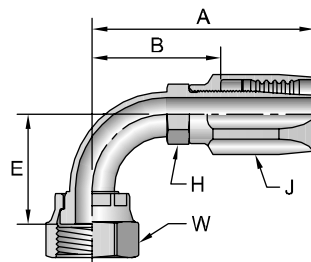

2J120

Female Seal-Lok® - Swivel - 90° Elbow - Long Drop
ISO 12151-1 - SWEL90

# Part Number	Thread		Hose I.D. inch	A		E		H inch	J inch	W inch	B	
	inch	inch		inch	mm	inch	mm				inch	mm
2J120-4-4	1/4	9/16x18	3/16	2.01	51	1.80	46	7/16	5/8	11/16	1.23	31
2J120-6-6	3/8	11/16x16	5/16	2.48	63	2.13	54	1/2	13/16	13/16	1.56	40
2J120-8-8	1/2	13/16x16	13/32	2.96	75	2.51	64	5/8	15/16	15/16	1.87	47

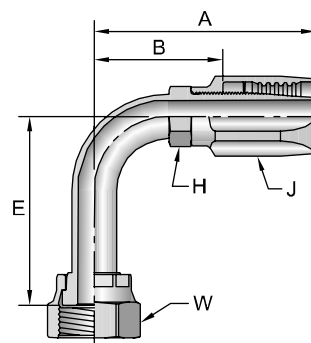

See Accessories Section for O-Rings.

20 Series Hose Assembly Instructions

A

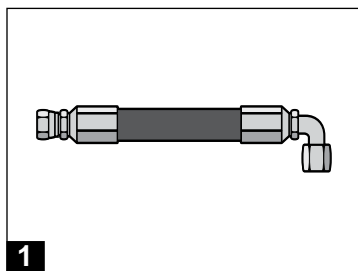

1. Identify over all length (OAL) of hose assembly and the cut off allowance (COA) length of fitting(s) on hose ends by use of the fitting data table. Properly measure, mark and cut hose to desired length using fine tooth hacksaw or cutoff machine. Care should be taken to ensure a square, clean cut is obtained.

B

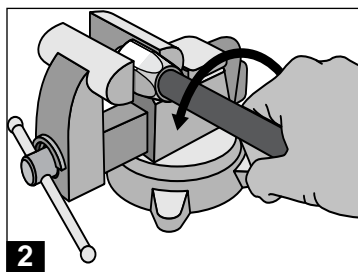

2. Air or solvent flush cut end of hose as necessary to produce a clean hose ID prior to assembly. Place socket in vice and screw in hose counter clockwise until hose bottoms. Back hose out 1/2 turn.

C

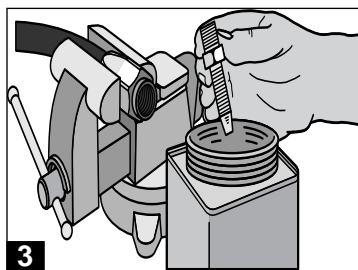

3. Oil inside of hose and nipple threads liberally with Hoze-Oil. (See Section C). Do not oil hose cover.

D

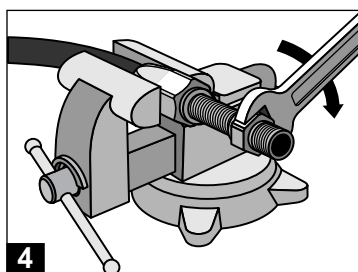

4. Screw nipple assembly into socket using a wrench on the nipple hex until the nipple hex shoulders against the socket. A 1/32" to 1/16" gap between the nipple hex and socket is allowed for displacement angle adjustment when two elbow fittings are used.

Inspection. Examine hose assembly internally for cut or bulged tube, obstructions and cleanliness. Clean ID of hose as necessary. Swivel nuts should turn freely. Check the layline of the hose to be sure the assembly is not twisted. Cap the ends of the assembly to keep clean.

Special Instructions for stainless steel fittings. When assembling fittings made with 316 stainless steel, lubricate the threads of both the socket and nipple with Accrolube High Efficiency Lubricant (see Section C) or equivalent metal assembly lubricant.











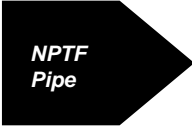
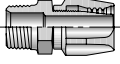

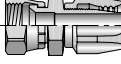
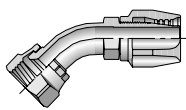
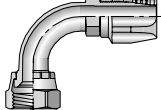
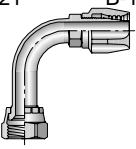
Note: DISASSEMBLE IN REVERSE ORDER

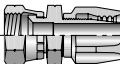
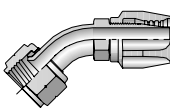
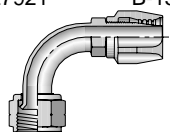
IF YOU HAVE QUESTIONS CONCERNING THE PRODUCTS
OR APPLICATION OF THE PRODUCTS CONTAINED IN THIS
CATALOG, PLEASE CALL: PARKER HOSE PRODUCTS
DIVISION - TECHNICAL SERVICES DEPARTMENT

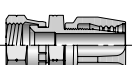
PHONE: 440/943-5700

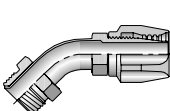
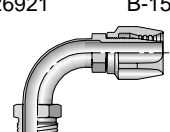
FAX: 440/943-3129

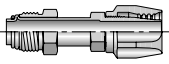
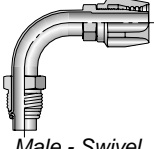
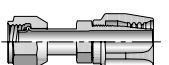
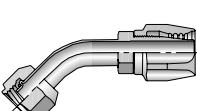
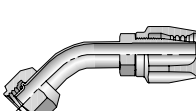
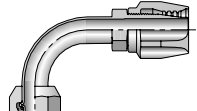
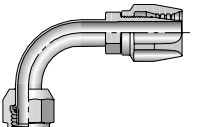
<http://www.parkerhose.com>

 NPTF Pipe	20121 B-152  <i>Male - Rigid</i>	 JIC 37°	20621 B-152  <i>Female - Swivel</i>	23721 B-152  <i>Female - Swivel 45° Elbow - Short</i>	23921 B-153  <i>Female - Swivel 90° Elbow - Short</i>
24121 B-153  <i>Female - Swivel 90° Elbow - Long</i>	 SAE 45°	20821 B-153  <i>Female - Swivel</i>	27721 B-153  <i>Female - Swivel 45° Elbow</i>	27921 B-154  <i>Female - Swivel 90° Elbow</i>	 PTT 30°
23221 B-154  <i>Female - Swivel</i>	 Inverted Flare	22821 B-154  <i>Male - Swivel</i>	26721 B-154  <i>Male - Swivel 45° Elbow</i>	26921 B-155  <i>Male - Swivel 90° Elbow</i>	 Tube-O
2S521 B-155  <i>Male - Swivel Short</i>	25M21 B-155  <i>Male - Swivel 90° Elbow - Long</i>	25S21 B-155  <i>Female - Swivel Short</i>	25H21 B-156  <i>Female - Swivel 45° Elbow - Short</i>	25N21 B-156  <i>Female - Swivel 45° Elbow - Long</i>	25T21 B-156  <i>Female - Swivel 90° Elbow - Short</i>
25L21 B-156  <i>Female - Swivel 90° Elbow - Long</i>	 Assembly Instructions	21 Series B-157 Assembly Instructions			

A

B

C

D

E

20121 Male NPTF Pipe - Rigid

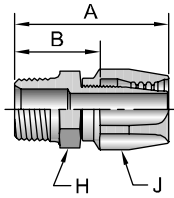

# Part Number	Thread		Hose I.D. inch	A		H inch	J inch	B	
	inch			inch	mm			inch	mm
20121-2-4	1/8x27		3/16	1.55	39	7/16	9/16	0.88	22
20121-4-4	1/4x18		3/16	1.77	45	9/16	9/16	1.10	28
20121-4-5	1/4x18		1/4	1.79	45	9/16	5/8	1.05	27
20121-4-6	1/4x18		5/16	1.92	49	9/16	3/4	1.14	29
20121-6-6	3/8x18		5/16	1.95	50	11/16	3/4	1.17	30
20121-6-8	3/8x18		13/32	2.10	53	11/16	7/8	1.18	30
20121-8-8	1/2x14		13/32	2.34	59	7/8	7/8	1.42	36
20121-8-10	1/2x14		1/2	2.44	62	7/8	1-1/16	1.44	37
20121-12-12	3/4x14		5/8	2.58	66	1-1/8	1-1/4	1.50	38
20121-12-16	3/4x14		7/8	2.50	64	1-1/4	1-7/16	1.51	38
20121-16-16	1x11-1/2		7/8	2.69	68	1-3/8	1-7/16	1.70	43
20121-20-20	1-1/4x11-1/2		1-1/8	2.91	74	1-11/16	1-3/4	1.87	47
20121-24-24	1-1/2x11-1/2		1-3/8	3.02	77	2	2	1.92	49

20621 Female JIC 37° - Swivel

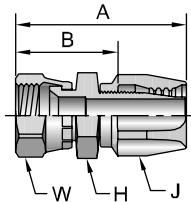

# Part Number	Thread		Hose I.D. inch	A		H inch	J inch	W inch	B	
	inch			inch	mm				inch	mm
20621-4-4	1/4	7/16x20	3/16	1.83	46	9/16	9/16	9/16	1.16	29
20621-5-5	5/16	1/2x20	1/4	1.92	49	5/8	5/8	5/8	1.18	30
20621-6-6	3/8	9/16x18	5/16	2.09	53	11/16	3/4	11/16	1.31	33
20621-8-8	1/2	3/4x16	13/32	2.46	62	7/8	7/8	7/8	1.54	39
20621-8-10	1/2	3/4x16	1/2	2.56	65	1	1-1/16	7/8	1.56	40
20621-10-10	5/8	7/8x14	1/2	2.65	67	1	1-1/16	1	1.65	42
20621-12-12	3/4	1-1/16x12	5/8	2.85	72	1-1/4	1-1/4	1-1/4	1.77	45
20621-16-16	1	1-5/16x12	7/8	2.94	75	1-1/2	1-7/16	1-1/2	1.95	50
20621-20-20	1-1/4	1-5/8x12	1-1/8	3.16	80	2	1-3/4	2	2.12	54

23721 Female JIC 37° - Swivel - 45° Elbow - Short Drop

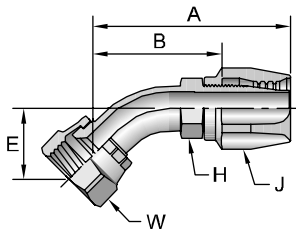

# Part Number	Thread		Hose I.D. inch	A		E		H inch	J inch	W inch	B	
	inch			inch	mm	inch	mm				inch	mm
23721-4-4	1/4	7/16x20	3/16	2.11	54	0.39	10	3/8	9/16	9/16	1.43	36
23721-6-6	3/8	9/16x18	5/16	2.26	57	0.40	10	1/2	3/4	11/16	1.48	38
23721-8-8	1/2	3/4x16	13/32	2.73	69	0.55	14	5/8	7/8	7/8	1.81	46
23721-10-10	5/8	7/8x14	1/2	2.97	75	0.64	16	3/4	1-1/16	1	1.97	50
23721-12-12	3/4	1-1/16x12	5/8	3.30	84	0.83	21	7/8	1-1/4	1-1/4	2.22	56
23721-16-16	1	1-5/16x12	7/8	3.44	87	0.90	23	1-1/8	1-7/16	1-1/2	2.45	62
23721-20-20	1-1/4	1-5/8x12	1-1/8	3.80	97	1.19	30	1-3/8	1-3/4	2	2.76	70

23921

Female JIC 37° - Swivel - 90° Elbow - Short Drop

# Part Number	Thread		Hose I.D. inch	A		E		H inch	J inch	W inch	B	
	inch	inch		inch	mm	inch	mm				inch	mm
23921-4-4	1/4	7/16 x 20	3/16	1.88	48	0.83	21	3/8	9/16	9/16	1.20	30
23921-4-6	1/4	7/16 x 20	5/16	1.95	50	0.83	21	1/2	3/4	9/16	1.17	30
23921-5-5	5/16	1/2 x 20	1/4	2.07	53	0.77	20	7/16	5/8	5/8	1.33	34
23921-6-6	3/8	9/16x18	5/16	2.15	55	0.85	22	1/2	3/4	11/16	1.37	35
23921-8-8	1/2	3/4 x 16	13/32	2.49	63	1.09	28	5/8	7/8	7/8	1.57	40
23921-10-10	5/8	7/8 x 14	1/2	2.69	68	1.23	31	3/4	1-1/16	1	1.69	43
23921-12-12	3/4	1-1/16 x 12	5/8	2.88	73	1.89	48	7/8	1-1/4	1-1/4	1.80	46
23921-16-16	1	1-5/16 x 12	7/8	3.40	86	2.14	54	1-1/8	1-7/16	1-1/2	2.41	61
23921-20-20	1-1/4	1-5/8 x 12	1-1/8	3.64	92	2.59	66	1-3/8	1-3/4	2	2.60	66

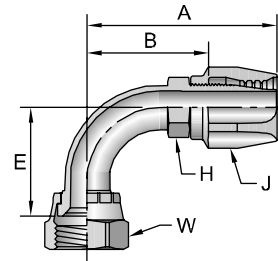

24121

Female JIC 37° - Swivel - 90° Elbow - Long Drop

# Part Number	Thread		Hose I.D. inch	A		E		H inch	J inch	W inch	B	
	inch	inch		inch	mm	inch	mm				inch	mm
24121-4-4	1/4	7/16x20	3/16	1.88	48	2.52	64	3/8	9/16	9/16	1.20	30
24121-6-6	3/8	9/16x18	5/16	2.14	54	2.18	55	1/2	3/4	11/16	1.36	35
24121-8-8	1/2	3/4x16	13/32	2.45	62	2.52	64	5/8	7/8	7/8	1.53	39
24121-10-10	5/8	7/8x14	1/2	2.91	74	2.57	65	3/4	1-1/16	1	1.91	49
24121-20-20	1-1/4	1-5/8x12	1-1/8	3.63	92	5.28	134	1-3/8	1-3/4	2	2.59	66

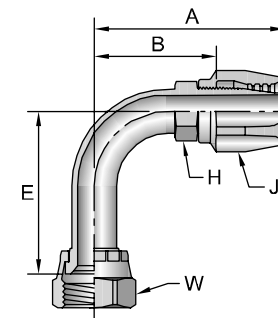

20821

Female SAE 45° - Swivel

# Part Number	Thread		Hose I.D. inch	A		H inch	J inch	W inch	B	
	inch	inch		inch	mm				inch	mm
20821-4-4	1/4	7/16x20	3/16	1.83	46	9/16	9/16	9/16	1.16	29
20821-5-5	5/16	1/2x20	1/4	1.91	49	5/8	5/8	5/8	1.17	30
20821-6-6	3/8	5/8x18	5/16	2.12	54	3/4	3/4	3/4	1.34	34
20821-8-8	1/2	3/4x16	13/32	2.46	62	7/8	7/8	7/8	1.54	39
20821-10-10	5/8	7/8x14	1/2	2.65	67	1	1-1/16	1	1.65	42
20821-12-12	3/4	1-1/16x14	5/8	2.85	72	1-1/4	1-1/4	1-1/4	1.77	45

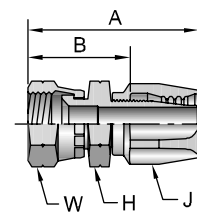

27721

Female SAE 45° - Swivel - 45° Elbow

# Part Number	Thread		Hose I.D. inch	A		E		H inch	J inch	W inch	B	
	inch	inch		inch	mm	inch	mm				inch	mm
27721-6-6	3/8	5/8x18	5/16	2.26	57	0.40	10	1/2	3/4	3/4	1.48	38
27721-12-12	3/4	1-1/16x14	5/8	3.30	84	0.83	21	7/8	1-1/4	1-1/4	2.22	56

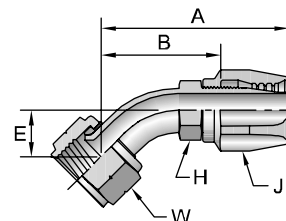

Notch in nut signifies 45° flare.

A

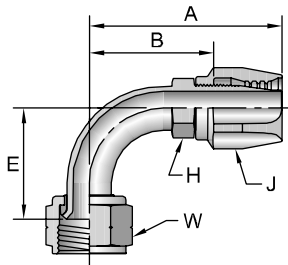

27921

Female SAE 45° - Swivel - 90° Elbow

# Part Number	Thread		Hose I.D. inch	A		E		H inch	J inch	W inch	B	
	inch	inch		inch	mm	inch	mm				inch	mm
27921-6-6	3/8	5/8x18	5/16	2.15	55	0.85	22	1/2	3/4	3/4	1.37	35
27921-12-12	3/4	1-1/16x14	5/8	2.88	73	1.89	48	7/8	1-1/4	1-1/4	1.89	46

Notch in nut signifies 45° flare.

B

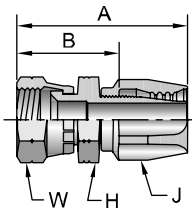

23221

Female PTT 30° - Swivel

# Part Number	Thread inch	Hose I.D. inch	A		H inch	J inch	W inch	B		
			inch	mm				inch	mm	
23221-16-16	1	1-5/16x14	7/8	2.70	69	1-1/2	1-7/16	1-1/2	1.71	43

C

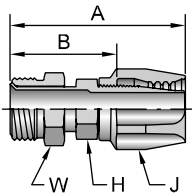

22821

Male Inverted SAE 45° - Swivel

# Part Number	Thread		Hose I.D. inch	A		H inch	J inch	W inch	B	
	inch	inch		inch	mm				inch	mm
22821-4-4	1/4	7/16x24	3/16	2.36	60	3/8	9/16	7/16	1.68	43
22821-5-4	5/16	1/2x20	3/16	2.32	59	7/16	9/16	1/2	1.64	42
22821-5-5	5/16	1/2x20	1/4	2.34	59	7/16	5/8	1/2	1.60	41
22821-5-6	5/16	1/2x20	5/16	2.47	63	1/2	3/4	1/2	1.69	43
22821-6-6	3/8	5/8x18	5/16	2.45	62	1/2	3/4	5/8	1.67	42
22821-8-8	1/2	3/4x18	13/32	2.84	72	5/8	7/8	3/4	1.92	49
22821-10-10	5/8	7/8x18	1/2	2.91	74	3/4	1-1/16	7/8	1.91	49

D

E

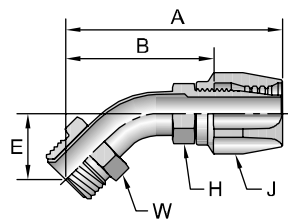

26721

Male Inverted SAE 45° - Swivel - 45° Elbow

# Part Number	Thread		Hose I.D. inch	A		E		H inch	J inch	W inch	B	
	inch	inch		inch	mm	inch	mm				inch	mm
26721-4-4	1/4	7/16x24	3/16	2.35	60	0.62	16	3/8	9/16	7/16	1.67	42
26721-5-5	5/16	1/2x20	1/4	2.59	66	0.94	24	7/16	5/8	1/2	1.85	47
26721-6-6	3/8	5/8x18	5/16	2.73	69	0.94	24	1/2	3/4	5/8	1.95	50
26721-8-8	1/2	3/4x18	13/32	3.05	77	0.94	24	5/8	7/8	3/4	2.13	54

26921

Male Inverted SAE 45° - Swivel - 90° Elbow

# Part Number	Thread inch	Hose I.D. inch	A		E		H inch	J inch	W inch	B		
			inch	mm	inch	mm				inch	mm	
26921-4-4	1/4	7/16x24	3/16	2.45	62	1.56	40	3/8	9/16	7/16	1.77	45
26921-5-5	5/16	1/2x20	1/4	2.25	57	1.65	42	7/16	5/8	1/2	1.51	38
26921-5-6	5/16	1/2x20	5/16	2.38	60	1.65	42	1/2	3/4	1/2	1.60	41
26921-6-6	3/8	5/8x18	5/16	2.37	60	1.63	41	1/2	3/4	5/8	1.59	40
26921-8-8	1/2	3/4x18	13/32	2.63	67	1.78	45	5/8	7/8	3/4	1.71	43
26921-10-10	5/8	7/8x18	1/2	2.96	75	2.17	55	3/4	1-1/16	7/8	1.96	50

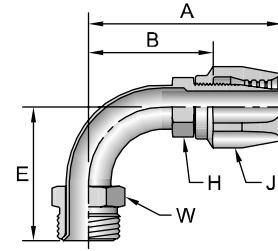

2S521

Male Tube-O - Swivel - Short Pilot

# Part Number	Thread inch	Hose I.D. inch	A		D		H inch	J inch	W inch	B		
			inch	mm	inch	mm				inch	mm	
2S521-6-6	3/8	5/8x18	5/16	2.64	67	0.18	4,7	1/2	3/4	5/8	1.86	47

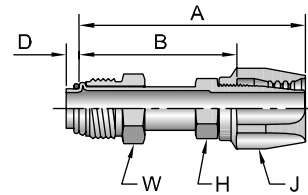

25M21

Male Tube-O - Swivel - 90° Elbow - Long Pilot

# Part Number	Thread inch	Hose I.D. inch	A		D		E		H inch	J inch	W inch	B		
			inch	mm	inch	mm	inch	mm				inch	mm	
25M21-8-8	1/2	3/4x18	13/32	2.49	63	0.38	9,8	2.12	54	5/8	7/8	3/4	1.57	40
25M21-10-10	5/8	7/8x18	1/2	3.27	83	0.38	9,8	1.95	50	3/4	1-1/16	7/8	2.27	58

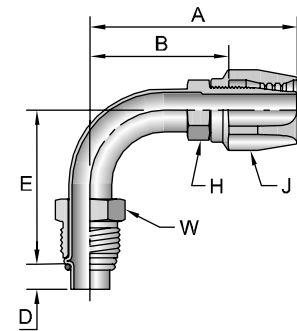

25S21

Female Tube-O - Swivel - Short Pilot

# Part Number	Thread inch	Hose I.D. inch	A		D		H inch	J inch	W inch	B		
			inch	mm	inch	mm				inch	mm	
25S21-6-6	3/8	5/8x18	5/16	2.66	68	0.18	4,7	1/2	3/4	3/4	1.88	48
25S21-8-8	1/2	3/4x16	13/32	2.86	73	0.18	4,7	5/8	7/8	7/8	1.94	49

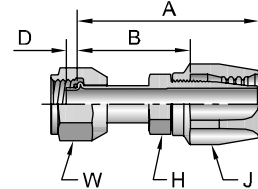

A

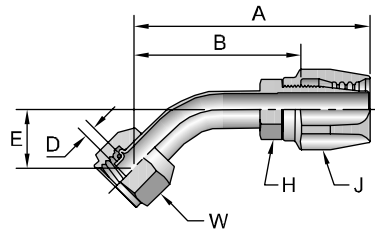

25H21

Female Tube-O - Swivel - 45° Elbow - Short Pilot

#			A		D		E					B	
Part Number	Thread	Hose I.D.	inch	mm	inch	mm	inch	mm	inch	inch	inch	inch	mm
25H21-8-8	1/2 3/4x16	13/32	2.74	70	0.18	4,7	0.60	15	5/8	7/8	7/8	1.82	46

B

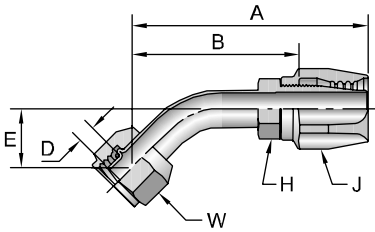

25N21

Female Tube-O - Swivel - 45° Elbow - Long Pilot

#			A		D		E					B	
Part Number	Thread	Hose I.D.	inch	mm	inch	mm	inch	mm	inch	inch	inch	inch	mm
25N21-8-8	1/2 3/4x16	13/32	3.24	82	0.38	9,8	0.98	25	5/8	7/8	7/8	2.32	59

C

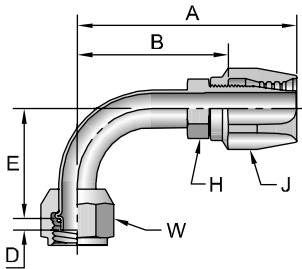

25T21

Female Tube-O - Swivel - 90° Elbow - Short Pilot

#			A		D		E					B	
Part Number	Thread	Hose I.D.	inch	mm	inch	mm	inch	mm	inch	inch	inch	inch	mm
25T21-6-6	3/8 5/8x18	5/16	2.35	60	0.18	4,7	1.21	31	1/2	3/4	3/4	1.57	40
25T21-8-8	1/2 3/4x16	13/32	2.83	72	0.18	4,7	1.31	33	5/8	7/8	7/8	1.91	49
25T21-10-10	5/8 7/8x14	1/2	3.33	85	0.18	4,7	1.50	38	3/4	1-1/16	1-1/16	2.33	59

D

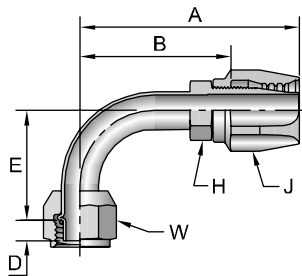

25L21

Female Tube-O - Swivel - 90° Elbow - Long Pilot

#			A		D		E					B	
Part Number	Thread	Hose I.D.	inch	mm	inch	mm	inch	mm	inch	inch	inch	inch	mm
25L21-6-6	3/8 5/8x18	5/16	2.28	58	0.28	7,1	1.43	36	1/2	3/4	3/4	1.50	38
25L21-8-8	1/2 3/4x16	13/32	2.50	64	0.38	9,8	1.46	37	5/8	7/8	7/8	1.58	40
25L21-10-10	5/8 7/8x14	1/2	2.83	72	0.38	9,8	1.75	44	3/4	1-1/16	1-1/16	1.83	46

E

21 Series Hose Assembly Instructions

1. Identify over all length (OAL) of hose assembly and the cut off allowance (COA) length of fitting(s) on hose ends by use of the fitting data table. Properly measure, mark and cut hose to desired length using fine tooth hacksaw or a cutoff machine. Care should be taken to ensure a square, clean cut is obtained.
2. Air or solvent flush cut end of hose as necessary to produce a clean hose ID prior to assembly. Place socket in vice and screw in hose counter clockwise until hose bottoms. Back hose out ½ turn.
3. Oil inside of hose and nipple threads liberally with Hoze-Oil. (See Section C). Do not oil hose cover.
4. Screw nipple assembly into socket using a wrench on the nipple hex until the nipple hex shoulders against the socket. A 1/32" to 1/16" gap between the nipple hex and socket is allowed for displacement angle adjustment when elbow fittings are used.

Inspection. Examine hose assembly internally for cut or bulged tube, obstructions and cleanliness. Clean ID of hose as necessary. Swivel nuts should turn freely. Check the layline of the hose to be sure the assembly is not twisted. Cap the ends of the assembly to keep clean.

Special instructions for stainless steel fittings. When assembling fittings made with 316 stainless steel, lubricate the threads of both the socket and nipple with Accrolube High Efficiency Lubricant (see Section C) or equivalent metal assembly lubricant.

Note: Disassemble in reverse order.

IF YOU HAVE QUESTIONS CONCERNING THE PRODUCTS
OR APPLICATION OF THE PRODUCTS CONTAINED IN THIS
CATALOG, PLEASE CALL: PARKER HOSE PRODUCTS
DIVISION - TECHNICAL SERVICES DEPARTMENT
PHONE: 440 / 943-5700
FAX: 440 / 943-3129
<http://www.parkerhose.com>

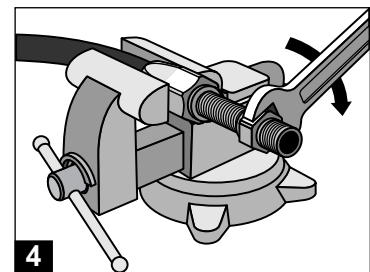
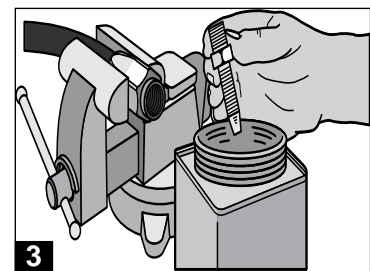
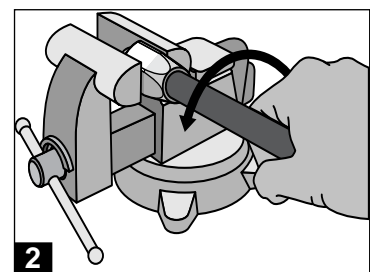
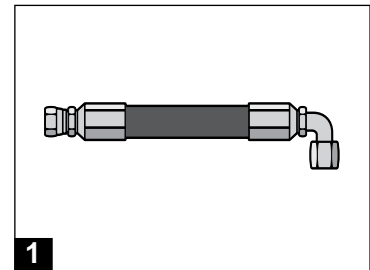

A

B

C

D

E







A

B

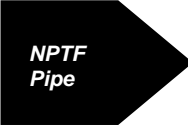
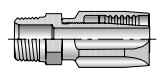
C

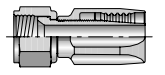
D

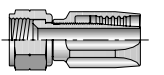
E

 <p>NPTF Pipe</p>	<p>20122 B-160</p>  <p><i>Male - Rigid</i></p>	 <p>JIC 37°</p>	<p>20622 B-160</p>  <p><i>Female - Swivel</i></p>	 <p>SAE 45°</p>	<p>20822 B-160</p>  <p><i>Female - Swivel</i></p>
 <p>Assembly Instructions</p>	<p>22 Series B-161 Assembly Instructions</p>				

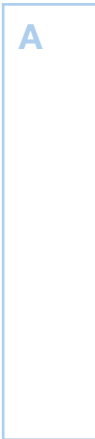

20122 Male NPTF Pipe - Rigid

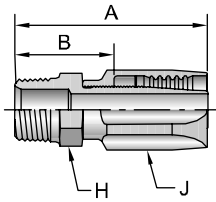

# Part Number	Thread		Hose I.D.		A		B		Additional Material Brass (B)
	inch	inch	inch	mm	inch	inch	inch	mm	
20122-2-4	1/8x27	3/16	1.72	44	7/16	5/8	0.94	24	
20122-4-4	1/4x18	3/16	1.92	49	9/16	5/8	1.92	29	•
20122-4-5	1/4x18	1/4	2.01	51	9/16	11/16	1.18	30	•
20122-4-6	1/4x18	5/16	2.11	54	9/16	13/16	1.19	30	•
20122-6-8	3/8x18	13/32	2.49	63	3/4	15/16	1.40	36	•
20122-12-12	3/4x14	5/8	3.25	83	1-1/16	1-1/4	1.75	44	•

20622 Female JIC 37° - Swivel

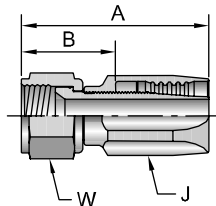

# Part Number	Thread		Hose I.D.		A		B		Additional Material Brass (B)	
	inch	inch	inch	mm	inch	inch	inch	mm		
20622-4-4~	1/4	7/16x20	3/16	1.74	44	5/8	9/16	0.96	24	•
20622-5-5~	5/16	1/2x20	1/4	1.91	49	11/16	5/8	1.08	27	•
20622-6-6	3/8	9/16x18	5/16	2.05	52	13/16	11/16	1.13	29	•
20622-8-8~	1/2	3/4x16	13/32	2.55	65	15/16	7/8	1.46	37	•
20622-10-10~	5/8	7/8x14	1/2	2.80	71	1-1/8	1	1.58	40	•
20622-12-12	3/4	1-1/16x12	5/8	3.15	80	1-1/4	1-1/8	1.65	42	•
20622-16-16	1	1-5/16x12	7/8	2.84	72	1-7/16	1-1/2	1.65	42	•
20622-20-20	1-1/4	1-5/8x12	1-1/8	3.00	76	1-3/4	2	1.72	44	•
20622-24-24	1-1/2	1-7/8x12	1-3/8	3.30	84	2	2-1/4	1.93	49	•
20622-32-32	2	2-1/2x12	1-13/16	4.05	103	2-1/2	2-7/8	2.31	59	•
20622-40-40	2-1/2	3x12	2-3/8	4.17	106	3-1/8	3-3/8	2.36	60	•

~These 20622 fittings contain a dual seat that accepts both the JIC (37°) and SAE (45°) male configurations. The -6 and -12 SAE (45°) swivel fittings are shown under part number 20822.

20822 Female SAE 45° - Swivel

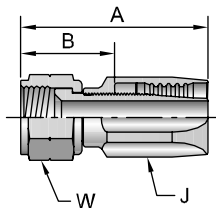

# Part Number	Thread		Hose I.D.		A		B		Additional Material Brass (B)	
	inch	inch	inch	mm	inch	inch	inch	mm		
20822-4-4	1/4	7/16x20	3/16	1.74	44	5/8	9/16	0.96	24	•
20822-5-5	5/16	1/2x20	1/4	1.91	49	11/16	5/8	1.08	27	•
20822-6-6	3/8	5/8x18	5/16	2.08	53	13/16	3/4	1.16	29	•
20822-8-8	1/2	3/4x16	13/32	2.45	62	15/16	7/8	1.36	35	•
20822-10-10	5/8	7/8x14	1/2	2.80	71	1-1/8	1	1.58	40	•
20822-12-12	3/4	1-1/16x14	5/8	3.10	79	1-1/4	1-1/4	1.60	41	•

Notch in nut for SAE (45°) flare.

22 Series

Mandrel Assembly Instructions

1. Identify over all length (OAL) of hose assembly and the cut off allowance (COA) length of fitting(s) on hose ends by use of the fitting data table. Properly measure, mark and cut hose to desired length using fine tooth hacksaw or a cutoff machine. Care should be taken to ensure a square, clean cut is obtained. Air or solvent flush cut end of hose as necessary to produce a clean hose ID prior to assembly. Place socket in vice and screw in hose counter clockwise until hose bottoms. Back hose out $\frac{1}{2}$ turn.
2. When assembling male pipe ends, slide nipple onto mandrel.
3. When assembling swivel ends, slide swivel nut over nipple. Slide nut and nipple onto mandrel. Screw mandrel threads into nipple and wrench tighten.
4. Oil inside of hose and nipple threads liberally with Hoze-Oil. (See Section C). **Do not oil hose cover.**
5. Push nipple into socket.
 - Male ends: Thread nipple in until it bottoms against socket.
 - Swivel ends: Thread nipple into socket using hex on assembly mandrel. Leave clearance of approximately $\frac{1}{32}$ " (.784mm) between nut and socket to allow nut to swivel. **Remove mandrel.**

Note: Disassemble in reverse order.

Caution: Do Not Attempt to Assemble These Fittings to the Hose Without Using a Mandrel.

Inspection. Examine hose assembly internally for cut or bulged tube, obstructions and cleanliness. Clean ID of hose as necessary. Swivel nuts should turn freely. Check the layline of the hose to be sure the assembly is not twisted. Cap the ends of the assembly to keep clean.

Special Instructions for Refrigerant Hose. Oil inside of hose and nipple threads liberally with the same oil used in refrigeration system. **Do not oil hose cover.** Do not allow hose to contact any petroleum base fluids.

IF YOU HAVE QUESTIONS CONCERNING THE PRODUCTS OR APPLICATION OF THE PRODUCTS CONTAINED IN THIS CATALOG, PLEASE CALL: PARKER HOSE PRODUCTS DIVISION TECHNICAL SERVICES DEPARTMENT

PHONE: 440 / 943-5700

FAX: 440 / 943-3129

<http://www.parkerhose.com>

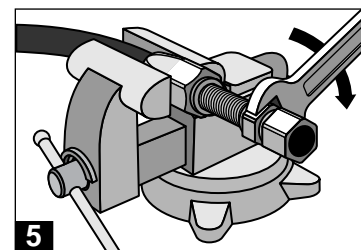
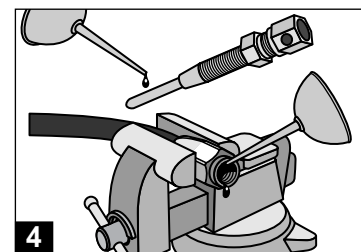
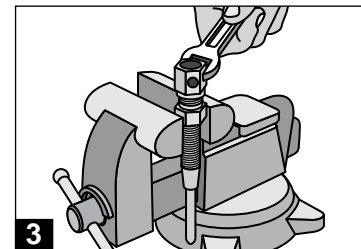
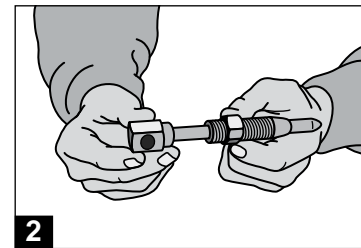
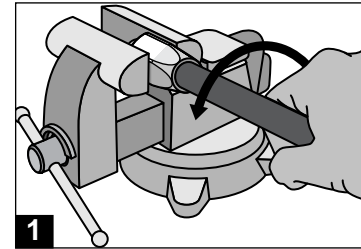

A

B

C

D

E





A

B

C

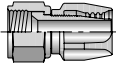
D

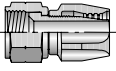
E

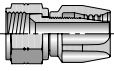
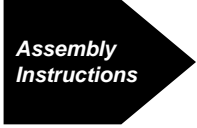
 <p>JIC 37°</p>	<p>20623 B-164</p>  <p><i>Female - Swivel</i></p>	 <p>SAE 45°</p>	<p>20823 B-164</p>  <p><i>Female - Swivel</i></p>	 <p>PTT 30°</p>	<p>23223 B-164</p>  <p><i>Female - Swivel</i></p>
 <p>Assembly Instructions</p>	<p>23 Series B-165 Assembly Instructions</p>				

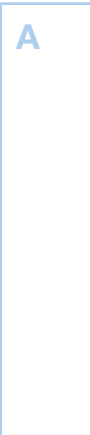

20623 Female JIC 37° - Swivel

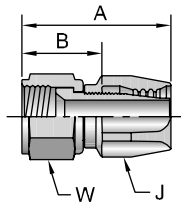

# Part Number	Thread		Hose I.D. inch	A		J inch	W inch	B	
	inch	inch		inch	mm			inch	mm
20623-4-4~	1/4	7/16x20	3/16	1.63	41	9/16	9/16	0.96	24
20623-5-5~	5/16	1/2x20	1/4	1.70	43	5/8	5/8	0.96	24
20623-6-6	3/8	9/16x18	5/16	1.91	49	3/4	11/16	1.13	29
20623-8-8~	1/2	3/4x16	13/32	2.16	55	7/8	7/8	1.24	31
20623-10-10~	5/8	7/8x14	1/2	2.37	60	1-1/16	1	1.37	35
20623-12-12	3/4	1-1/16x12	5/8	2.51	64	1-1/4	1-1/4	1.43	36
20623-16-16	1	1-5/16x12	7/8	2.50	64	1-7/16	1-1/2	1.51	38
20623-20-20	1-1/4	1-5/8x12	1-1/8	2.75	70	1-3/4	2	1.71	43
20623-24-24	1-1/2	1-7/8x12	1-3/8	3.00	76	2	2-1/4	1.90	48
20623-32-32	2	2-1/2x12	1-13/16	3.57	91	2-3/8	2-7/8	2.28	58

~ These 20623 fittings contain a dual seat that accepts both the JIC (37°) and SAE (45°) male configurations. The -6 and -12 SAE (45°) swivel fittings are shown under part number 20823.

20823 Female SAE 45° - Swivel

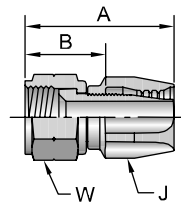

# Part Number	Thread		Hose I.D. inch	A		J inch	W inch	B		Additional Material Brass (B)
	inch	inch		inch	mm			inch	mm	
20823-4-4	1/4	7/16x20	3/16	1.68	43	9/16	9/16	1.01	26	•
20823-6-6	3/8	5/8x18	5/16	1.94	49	3/4	3/4	1.16	29	•
20823-8-8	1/2	3/4x16	13/32	2.08	53	7/8	7/8	1.16	29	•
20823-10-10	5/8	7/8x14	1/2	2.33	59	1-1/16	1	1.33	34	•
20823-12-12	3/4	1-1/16x14	5/8	2.47	63	1-1/4	1-1/4	1.39	35	•

Notch on nut signifies SAE 45° flared fitting.

23223 Female PTT 30° - Swivel

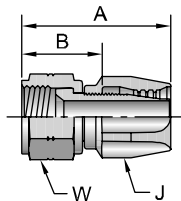

# Part Number	Thread		Hose I.D. inch	A		J inch	W inch	B	
	inch	inch		inch	mm			inch	mm
23223-16-16	1	1-5/16x14	7/8	2.29	58	1-7/16	1-1/2	1.30	33
23223-20-20	1-1/4	1-5/8x14	1-1/8	2.62	67	1-3/4	2	1.58	40

23 Series

Mandrel Assembly Instructions

1. Identify over all length (OAL) of hose assembly and the cut off allowance (COA) length of fitting(s) on hose ends by use of the fitting data table. Properly measure, mark and cut hose to desired length using fine tooth hacksaw or a cutoff machine. Care should be taken to ensure a square, clean cut is obtained. Air or solvent flush cut end of hose as necessary to produce a clean hose ID prior to assembly. Place socket in vice and screw in hose counter clockwise until hose bottoms. Back hose out $\frac{1}{2}$ turn.
2. When assembling male pipe ends, slide nipple onto mandrel.
3. When assembling swivel ends, slide swivel nut over nipple. Slide nut and nipple onto mandrel. Screw mandrel threads into nipple and wrench tighten.
4. Oil inside of hose and nipple threads liberally with Hoze-Oil. (See Section C). **Do not oil hose cover.**
5. Push nipple into socket.
 - Male ends: Thread nipple in until it bottoms against socket.
 - Swivel ends: Thread nipple into socket using hex on assembly mandrel. Leave clearance of approximately $\frac{1}{32}$ " (.784mm) between nut and socket to allow nut to swivel. **Remove mandrel.**

Note: Disassemble in reverse order.

Caution: Do Not Attempt to Assemble These Fittings to the Hose Without Using a Mandrel.

Inspection. Examine hose assembly internally for cut or bulged tube, obstructions and cleanliness. Clean ID of hose as necessary. Swivel nuts should turn freely. Check the layline of the hose to be sure the assembly is not twisted. Cap the ends of the assembly to keep clean.

Special Instructions for Refrigerant Hose. Oil inside of hose and nipple threads liberally with the same oil used in refrigeration system. **Do not oil hose cover.** Do not allow hose to contact any petroleum base fluids.

IF YOU HAVE QUESTIONS CONCERNING THE PRODUCTS OR APPLICATION OF THE PRODUCTS CONTAINED IN THIS CATALOG, PLEASE CALL: PARKER HOSE PRODUCTS DIVISION TECHNICAL SERVICES DEPARTMENT

PHONE: 440 / 943-5700

FAX: 440 / 943-3129

<http://www.parkerhose.com>

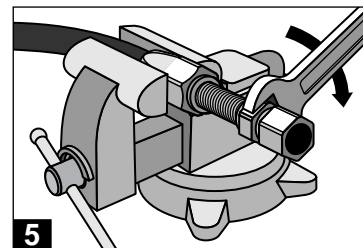
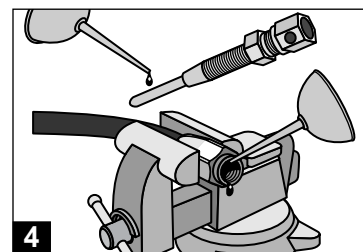
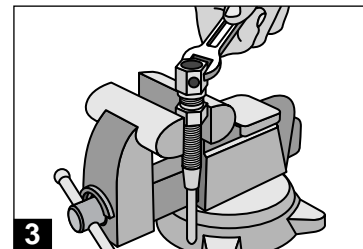
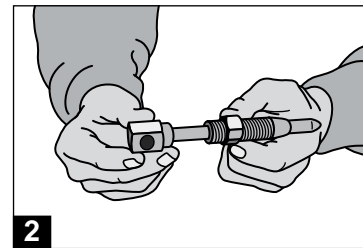
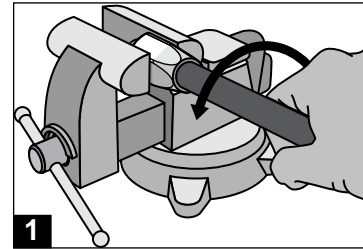

A

B

C

D

E







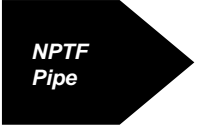
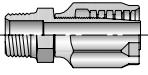
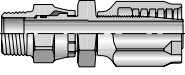
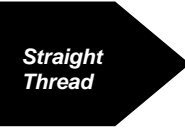
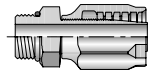

A

B

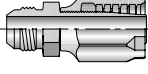
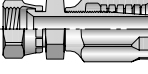
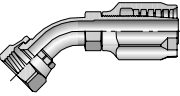
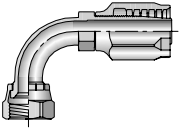
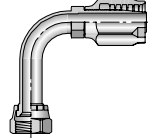
C

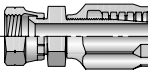
D

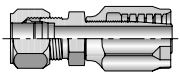
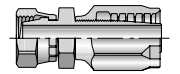
E

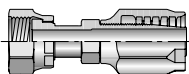
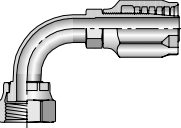
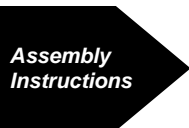
 <p>NPTF Pipe</p>	<p>20130 B-168</p>  <p><i>Male - Rigid</i></p>	<p>21330 B-168</p>  <p><i>Male - Swivel</i></p>	 <p>Straight Thread</p>	<p>20530 B-168</p>  <p><i>Male - Rigid</i></p>	 <p>JIC 37°</p>
<p>20330 B-169</p>  <p><i>Male - Rigid</i></p>	<p>20630 B-169</p>  <p><i>Female - Swivel</i></p>	<p>23730 B-170</p>  <p><i>Female - Swivel 45° Elbow - Short</i></p>	<p>23930 B-170</p>  <p><i>Female - Swivel 90° Elbow - Short</i></p>	<p>24130 B-170</p>  <p><i>Female - Swivel 45° Elbow - Long</i></p>	 <p>SAE</p>
<p>20830 B-170</p>  <p><i>Female - Swivel</i></p>	 <p>Flareless</p>	<p>21130 B-171</p>  <p><i>Male - Rigid</i></p>	<p>21230 B-171</p>  <p><i>Female - Swivel</i></p>	 <p>Seal-Lok® O-Ring Face Seal</p>	<p>2JS30 B-171</p>  <p><i>Female - Swivel Long</i></p>
<p>2J930 B-171</p>  <p><i>Female - Swivel 90° Elbow - Short</i></p>	 <p>Assembly Instructions</p>	<p>30 Series Assembly Instructions B-172</p>			

A

B

C

D

E

A

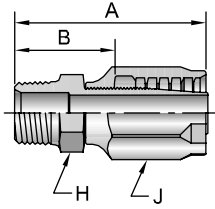

20130 Male NPTF Pipe - Rigid

# Part Number	Thread inch	Hose I.D. inch	A		H inch	J inch	B	
			inch	mm			inch	mm
20130-2-3	1/8x27	3/16	2.01	51	1/2	3/4	1.23	31
20130-2-4	1/8x27	1/4	2.19	56	9/16	3/4	1.23	31
20130-4-4	1/4x18	1/4	2.38	60	9/16	3/4	1.42	36
20130-4-6	1/4x18	3/8	2.58	66	11/16	15/16	1.44	37
20130-6-4	3/8x18	1/4	2.38	60	3/4	3/4	1.41	36
20130-6-6	3/8x18	3/8	2.58	66	3/4	15/16	1.44	37
20130-6-8	3/8x18	1/2	2.92	74	7/8	1-1/16	1.58	40
20130-8-6	1/2x14	3/8	2.77	70	7/8	15/16	1.63	41
20130-8-8	1/2x14	1/2	3.11	79	7/8	1-1/16	1.77	45
20130-12-12	3/4x14	3/4	3.20	81	1-1/8	1-3/8	1.77	45
20130-16-16	1x11-1/2	1	3.74	95	1-3/8	1-3/4	2.03	52
20130-20-20	1-1/4x11-1/2	1-1/4	4.59	117	1-3/4	2-1/4	2.46	62

B

21330 Male NPTF Pipe - Swivel

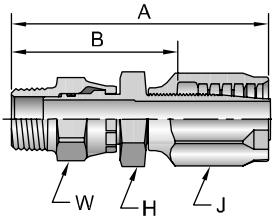

# Part Number	Thread inch	Hose I.D. inch	A		H inch	J inch	W inch	B	
			inch	mm				inch	mm
21330-4-4	1/4x18	1/4	3.42	87	9/16	3/4	5/8	2.46	62
21330-6-6	3/8x18	3/8	3.67	93	7/8	15/16	3/4	2.53	64
21330-8-8	1/2x14	1/2	4.20	107	1	1-1/16	7/8	2.86	73
21330-12-12	3/4x14	3/4	4.30	109	1	1-3/8	1	2.87	73
21330-16-16	1x11-1/2	1	4.93	125	1-1/2	1-3/4	1-1/2	3.22	82

C

D

20530 Male SAE Straight Thread with O-Ring - Rigid

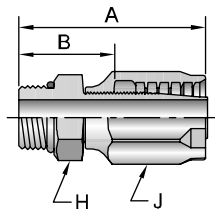

# Part Number	Thread inch	Hose I.D. inch	A		H inch	J inch	B		
			inch	mm			inch	mm	
20530-4-4	1/4	7/16x20	1/4	2.22	56	9/16	3/4	1.26	32
20530-6-6	3/8	9/16x18	3/8	2.45	62	11/16	15/16	1.31	33
20530-8-8	1/2	3/4x16	1/2	2.87	73	7/8	1-1/16	1.53	39

E

O-Rings are not compatible with Phosphate Ester fluids.

20330

Male JIC 37° - Rigid

# Part Number	Thread		Hose I.D. inch	A		H inch	J inch	B	
	inch	7/16x20		inch	mm			inch	mm
20330-4-4	1/4	7/16x20	1/4	2.37	60	9/16	3/4	1.41	36
20330-5-4	5/16	1/2x20	1/4	2.37	60	9/16	3/4	1.41	36
20330-6-4	3/8	9/16x18	1/4	2.38	60	5/8	3/4	1.42	36
20330-6-6	3/8	9/16x18	3/8	2.58	66	3/4	15/16	1.44	37
20330-8-6	1/2	3/4x16	3/8	2.68	68	13/16	15/16	1.54	39
20330-8-8	1/2	3/4x16	1/2	3.02	77	7/8	1-1/16	1.68	43
20330-10-8	5/8	7/8x14	1/2	3.12	79	15/16	1-1/16	1.78	45
20330-10-10	5/8	7/8x14	5/8	3.29	84	15/16	1-1/4	1.83	46
20330-12-12	3/4	1-1/16x12	3/4	3.31	84	1-1/8	1-3/8	1.88	48
20330-16-16	1	1-5/16x12	1	3.71	94	1-3/8	1-3/4	2	51

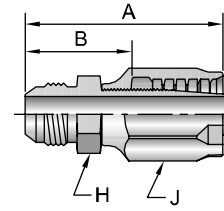

A

20630

Female JIC 37° - Swivel

# Part Number	Thread		Hose I.D. inch	A		H inch	J inch	W inch	B		Additional Material Stainless Steel (C)
	inch	7/16x20		inch	mm				inch	mm	
20630-4-3	1/4	7/16x20	3/16	2.27	58	9/16	3/4	9/16	1.49	38	
20630-4-4	1/4	7/16x20	1/4	2.45	62	9/16	3/4	9/16	1.49	38	•
20630-5-4	5/16	1/2x20	1/4	2.52	64	5/8	3/4	5/8	1.56	40	
20630-6-4	3/8	9/16x18	1/4	2.54	65	11/16	3/4	11/16	1.58	40	•
20630-6-6	3/8	9/16x18	3/8	2.74	70	11/16	15/16	11/16	1.60	41	•
20630-8-6	1/2	3/4x16	3/8	2.86	73	7/8	15/16	7/8	1.72	44	•
20630-8-8	1/2	3/4x16	1/2	3.20	81	7/8	1-1/16	7/8	1.86	47	•
20630-10-8	5/8	7/8x14	1/2	3.30	84	1	1-1/16	1	1.96	50	
20630-10-10	5/8	7/8x14	5/8	3.54	90	1	1-1/4	1	2.08	53	
20630-10-12	5/8	7/8x14	3/4	3.40	86	1-1/8	1-3/8	1	1.97	50	
20630-12-8	3/4	1-1/16x12	1/2	3.47	88	1-1/4	1-1/16	1-1/4	2.13	54	
20630-12-10	3/4	1-1/16x12	5/8	3.64	92	1-1/4	1-1/4	1-1/4	2.18	55	
20630-12-12	3/4	1-1/16x12	3/4	3.50	89	1-1/4	1-3/8	1-1/4	2.07	53	•
20630-14-12	7/8	1-3/16x12	3/4	3.50	89	1-3/8	1-3/8	1-3/8	2.07	53	
20630-16-12	1	1-5/16x12	3/4	3.59	91	1-1/2	1-3/4	1-1/2	2.16	55	
20630-16-16	1	1-5/16x12	1	3.94	100	1-1/2	1-3/4	1-1/2	2.23	57	
20630-20-16	1-1/4	1-5/8x12	1	4.17	106	2	1-3/4	2	2.46	62	
20630-20-20	1-1/4	1-5/8x12	1-1/4	4.96	126	2	2-1/4	2	2.83	72	
20630-24-24	1-1/2	1-7/8x12	1-1/2	5.26	134	2-1/4	2-1/2	2-1/4	3.05	77	
20630-32-32	2	2-1/2x12	2	6.42	163	2-7/8	3	2-7/8	3.92	100	

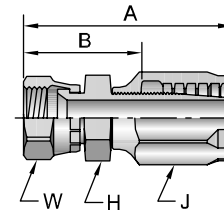

B

C

D

E

A

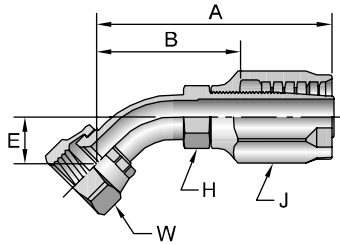

23730

Female JIC 37° - Swivel - 45° Elbow - Short Drop

# Part Number	Thread inch	Hose I.D. inch	A		E		H inch	J inch	W inch	B		
			inch	mm	inch	mm				inch	mm	
23730-4-4	1/4	7/16x20	1/4	2.70	69	0.33	8	7/16	3/4	9/16	1.74	44
23730-6-6	3/8	9/16x18	3/8	3.01	76	0.39	10	9/16	15/16	11/16	1.87	47
23730-8-8	1/2	3/4x16	1/2	3.55	90	0.55	14	11/16	1-1/16	7/8	2.21	56
23730-10-8	5/8	7/8x14	1/2	3.61	92	0.65	17	13/16	1-1/16	1	2.27	58
23730-12-12	3/4	1-1/16x12	3/4	3.93	100	0.79	20	15/16	1-3/8	1-1/4	2.50	64
23730-16-16	1	1-5/16x12	1	4.51	115	0.90	23	1-1/4	1-3/4	1-1/2	2.80	71

B

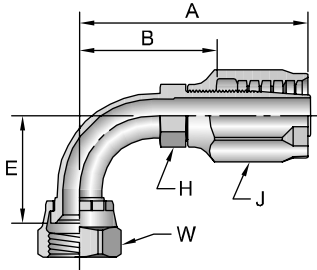

23930

Female JIC 37° - Swivel - 90° Elbow - Short Drop

# Part Number	Thread inch	Hose I.D. inch	A		E		H inch	J inch	W inch	B		
			inch	mm	inch	mm				inch	mm	
23930-4-4	1/4	7/16x20	1/4	2.52	64	0.83	21	7/16	3/4	9/16	1.56	40
23930-6-6	3/8	9/16x18	3/8	2.91	74	0.85	22	9/16	15/16	11/16	1.77	45
23930-8-6	1/2	3/4x16	3/8	3.04	77	1.09	28	11/16	15/16	7/8	1.90	48
23930-8-8	1/2	3/4x16	1/2	3.32	84	1.09	28	11/16	1-1/16	7/8	1.98	50
23930-10-8	5/8	7/8x14	1/2	3.46	88	1.24	31	13/16	1-1/16	1	2.12	54
23930-12-12	3/4	1-1/16x12	3/4	3.86	98	1.81	46	15/16	1-3/8	1-1/4	2.43	62
23930-16-16	1	1-5/16x12	1	4.48	114	2.14	54	1-1/4	1-3/4	1-1/2	2.77	70

C

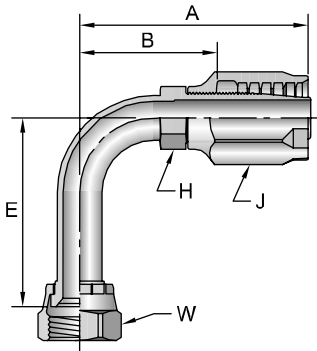

24130

Female JIC 37° - Swivel - 90° Elbow - Long Drop

# Part Number	Thread inch	Hose I.D. inch	A		E		H inch	J inch	W inch	B		
			inch	mm	inch	mm				inch	mm	
24130-6-6	3/8	9/16x18	3/8	2.90	74	2.18	55	9/16	15/16	11/16	1.76	45
24130-8-8	1/2	3/4x16	1/2	3.39	86	2.43	62	11/16	1-1/16	7/8	2.05	52

D

E

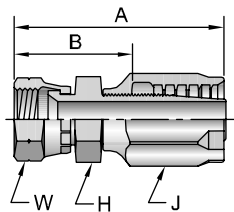

20830

Female SAE 45° - Swivel

# Part Number	Thread inch	Hose I.D. inch	A		H inch	J inch	W inch	B		
			inch	mm				inch	mm	
20830-6-6	3/8	5/8x18	3/8	2.81	71	3/4	15/16	3/4	1.67	42

Notch on nut signifies SAE 45° flare.

21130

Male Ferulok Flareless - Rigid - (24° Cone with Nut and Ferrule)

# Part Number	Thread		Hose I.D. inch	A		H	J	W	B	
	inch			inch	mm	inch	inch	inch	inch	mm
21130-16-16	1	1-5/16x12	1	4.15	105	1-3/8	1-3/4	1-1/2	2.44	62

The Parker Ferrul-Fix fitting makes it possible to salvage the bent tube section from a hose assembly for quick, easy on-the-job repairs. For additional information see Ferrule-Fix installation instructions in the Technical Section.

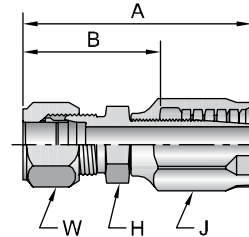

21230

Female Ferulok Flareless - Swivel - (24° Cone)

# Part Number	Thread		Hose I.D. inch	A		H	J	W	B	
	inch			inch	mm	inch	inch	inch	inch	mm
21230-4-4	1/4	7/16x20	1/4	2.62	67	9/16	3/4	9/16	1.66	42
21230-6-6	3/8	9/16x18	3/8	2.94	75	11/16	15/16	11/16	1.80	46
21230-8-6	1/2	3/4x16	3/8	3.16	80	7/8	15/16	7/8	2.02	51
21230-8-8	1/2	3/4x16	1/2	3.44	87	7/8	1-1/16	7/8	2.10	53
21230-12-12	3/4	1-1/16x12	3/4	3.86	98	1-1/4	1-3/8	1-1/4	2.43	62

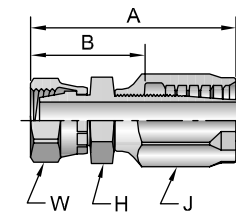

2JS30

Female Seal-Lok® - Swivel - Long ISO 12151-1 - SWSB

# Part Number	Thread		Hose I.D. inch	A		H	J	W	B	
	inch			inch	mm	inch	inch	inch	inch	mm
2JS30-4-4	1/4	9/16x18	1/4	2.62	67	9/16	3/4	11/16	1.66	42
2JS30-6-6	3/8	11/16x16	3/8	2.89	73	9/16	15/16	13/16	1.75	44
2JS30-8-8	1/2	13/16x16	1/2	3.32	84	11/16	1-1/16	15/16	1.98	50
2JS30-12-12	3/4	1-3/16x12	3/4	3.65	93	15/16	1-3/8	1-3/8	2.22	56

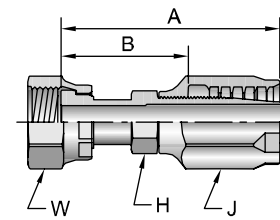

2J930

Female Seal-Lok® - Swivel - 90° Elbow - Short Drop ISO 12151-1 - SWES90

# Part Number	Thread		Hose I.D. inch	A		E		H	J	W	B	
	inch			inch	mm	inch	mm	inch	inch	inch	inch	mm
2J930-4-4	1/4	9/16x18	1/4	2.83	72	0.82	21	7/16	3/4	11/16	1.87	47
2J930-6-6	3/8	11/16x16	3/8	2.91	74	0.90	23	9/16	15/16	13/16	1.77	45
2J930-8-8	1/2	13/16x16	1/2	3.31	84	1.15	29	11/16	1-1/16	15/16	1.97	50
2J930-10-10	5/8	1x14	5/8	3.57	91	1.27	32	7/8	1-1/4	1-1/8	2.11	54
2J930-12-12	3/4	1-3/16x12	3/4	3.71	94	1.85	47	15/16	1-3/8	1-3/8	2.28	58

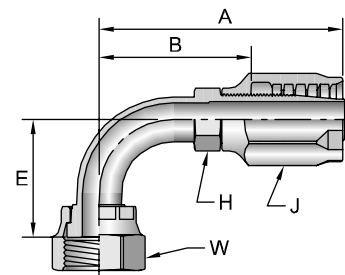

See Accessories Section for O-Rings.

30 Series Hose Assembly Instructions

A

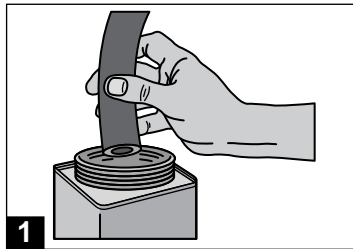

1. Identify over all length (OAL) of hose assembly and the cut off allowance (COA) length of fitting(s) on hose ends by use of the fitting data table. Properly measure, mark and cut hose to desired length using fine tooth hacksaw or a cutoff machine. Dip hose end into Hoze-Oil (See Section C) or heavy oil.

B

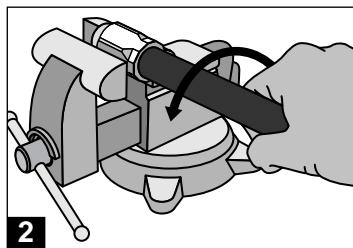

2. Place socket in vice and screw in hose counter-clockwise until hose bottoms. Back hose out 1/2 turn.

C

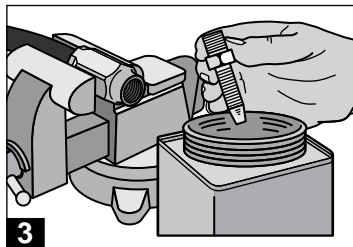

3. Dip hose end of nipple into Hoze-Oil or other heavy oil up to the hex. When assembling fittings of 316 stainless steel lubricate the threads of both the socket and nipple with Dow Corning Molykote G-n or equivalent metal assembly lubricant.

D

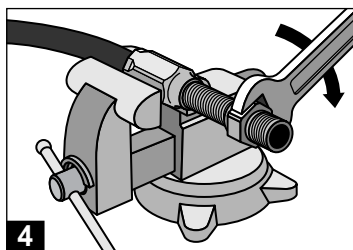

4. Screw nipple assembly into socket using wrench on nipple hex until nipple hex shoulders against socket.

E









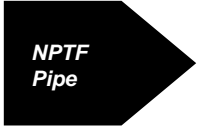
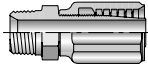
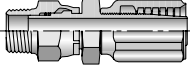

Note: Disassemble in reverse order.

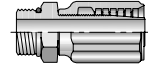
IF YOU HAVE QUESTIONS CONCERNING THE PRODUCTS
OR APPLICATION OF THE PRODUCTS CONTAINED IN THIS
CATALOG, PLEASE CALL: PARKER HOSE PRODUCTS
DIVISION TECHNICAL SERVICES DEPARTMENT

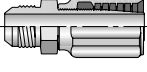
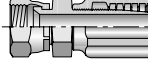
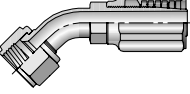
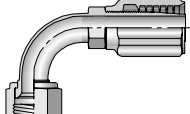
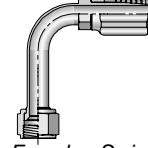
PHONE: 440 / 943-5700

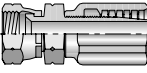
FAX: 440 / 943-3129

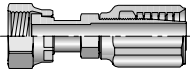
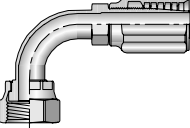
<http://www.parkerhose.com>

 <p>NPTF Pipe</p>	<p>20142 B-174</p>  <p><i>Male - Rigid</i></p>	<p>21342 B-174</p>  <p><i>Male - Swivel</i></p>	 <p>SAE</p>	<p>20542 B-174</p>  <p><i>Male - Rigid</i></p>	 <p>JIC 37°</p>
<p>20342 B-175</p>  <p><i>Male - Rigid</i></p>	<p>20642 B-175</p>  <p><i>Female - Swivel</i></p>	<p>23742 B-176</p>  <p><i>Female - Swivel 45° Elbow - Short</i></p>	<p>23942 B-176</p>  <p><i>Female - Swivel 90° Elbow - Short</i></p>	<p>24142 B-176</p>  <p><i>Female - Swivel 45° Elbow - Long</i></p>	 <p>SAE</p>
<p>20842 B-176</p>  <p><i>Female - Swivel</i></p>	 <p>Seal-Lok® O-Ring Face Seal</p>	<p>2JS42 B-177</p>  <p><i>Female - Swivel Long</i></p>	<p>2J942 B-177</p>  <p><i>Female - Swivel 90° Elbow - Short</i></p>	 <p>Assembly Instructions</p>	<p>42 Series Assembly Instructions</p> <p>B-178</p>

A

B

C

D

E

20142
Male NPTF Pipe - Rigid

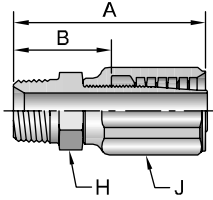

# Part Number	Thread inch	Hose I.D. inch	A		H inch	J inch	B	
			inch	mm			inch	mm
20142-2-3	1/8x27	3/16	2.09	53	1/2	5/8	1.31	33
20142-2-4	1/8x27	1/4	2.17	55	9/16	11/16	1.25	32
20142-4-3	1/4x18	3/16	2.28	58	9/16	5/8	1.50	38
20142-4-4	1/4x18	1/4	2.36	60	9/16	11/16	1.44	37
20142-4-5	1/4x18	5/16	2.39	61	9/16	13/16	1.44	37
20142-4-6	1/4x18	3/8	2.60	66	11/16	7/8	1.45	37
20142-6-6	3/8x18	3/8	2.60	66	3/4	7/8	1.45	37
20142-8-8	1/2x14	1/2	3.02	77	7/8	1	1.69	43
20142-8-10	1/2x14	5/8	3.29	84	15/16	1-1/8	1.87	47
20142-12-12	3/4x14	3/4	3.23	82	1-1/8	1-3/8	1.75	44
20142-16-16	1x11-1/2	1	3.61	92	1-3/8	1-5/8	2.07	53

21342
Male NPTF Pipe - Swivel

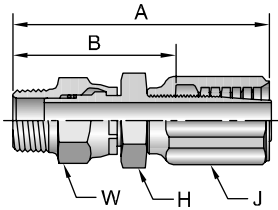

# Part Number	Thread inch	Hose I.D. inch	A		H inch	J inch	W inch	B	
			inch	mm				inch	mm
21342-4-4	1/4x18	1/4	3.40	86	9/16	11/16	5/8	2.48	63
21342-6-6	3/8x18	3/8	3.69	94	7/8	7/8	3/4	2.54	65

20542
Male SAE Straight Thread with O-Ring - Rigid

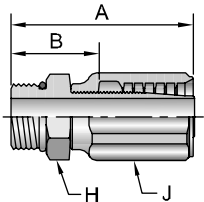

# Part Number	Thread inch	Hose I.D. inch	A		H inch	J inch	B	
			inch	mm			inch	mm
20542-4-4	1/4 7/16X20	1/4	2.2	56	9/16	11/16	1.28	33
20542-6-6	3/8 9/16x18	3/8	2.47	63	11/16	7/8	1.32	34
20542-8-8	1/2 3/4X16	1/2	2.78	71	7/8	1	1.45	37

O-Rings are not compatible with Phosphate Ester fluids.

20342
Male JIC 37° - Rigid

# Part Number	Thread		Hose I.D. inch	A		H inch	J inch	B	
	inch	inch		inch	mm			inch	mm
20342-4-4	1/4	7/16x20	1/4	2.35	60	9/16	11/16	1.43	36
20342-6-4	3/8	9/16x18	1/4	2.36	60	5/8	11/16	1.44	36
20342-6-5	3/8	9/16x18	5/16	2.39	61	5/8	13/16	1.43	36
20342-6-6	3/8	9/16x18	3/8	2.60	66	3/4	7/8	1.45	37
20342-8-6	1/2	3/4x16	3/8	2.70	69	13/16	7/8	1.55	39
20342-8-8	1/2	3/4x16	1/2	2.93	74	7/8	1	1.60	41
20342-10-10	5/8	7/8x14	5/8	3.24	82	15/16	1-1/8	1.82	46
20342-12-12	3/4	1-1/16x12	3/4	3.34	85	1-1/8	1-3/8	1.86	47
20342-16-16	1	1-5/16x12	1	3.58	91	1-3/8	1-5/8	2.04	52

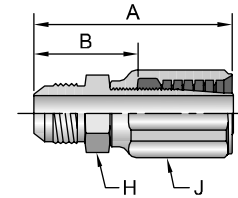

20642
Female JIC 37° - Swivel

# Part Number	Thread		Hose I.D. inch	A		H inch	J inch	W inch	B		Additional Material Stainless Steel (C)
	inch	inch		inch	mm				inch	mm	
20642-4-3	1/4	7/16x20	3/16	2.34	59	9/16	5/8	9/16	1.56	40	
20642-4-4	1/4	7/16x20	1/4	2.43	62	9/16	11/16	9/16	1.51	38	
20642-5-4	5/16	1/2x20	1/4	2.50	64	5/8	11/16	5/8	1.58	40	
20642-6-4	3/8	9/16x18	1/4	2.52	64	11/16	11/16	11/16	1.60	41	
20642-6-5	3/8	9/16x18	5/16	2.55	65	11/16	13/16	11/16	1.60	41	
20642-6-6	3/8	9/16x18	3/8	2.76	70	11/16	7/8	11/16	1.61	41	•
20642-8-6	1/2	3/4x16	3/8	2.88	73	7/8	7/8	7/8	1.73	44	
20642-8-8	1/2	3/4x16	1/2	3.11	79	7/8	1	7/8	1.78	45	•
20642-10-8	5/8	7/8x14	1/2	3.21	82	1	1	1	1.88	48	
20642-10-10	5/8	7/8x14	5/8	3.49	89	1	1-1/8	1	2.07	53	
20642-10-12	5/8	7/8x14	3/4	3.43	87	1-1/8	1-3/8	1	1.95	50	
20642-12-12	3/4	1-1/16x12	3/4	3.53	90	1-1/4	1-3/8	1-1/4	2.05	52	
20642-16-12	1	1-5/16x12	3/4	3.62	92	1-1/2	1-3/8	1-1/2	2.14	54	
20642-16-16	1	1-5/16x12	1	3.81	97	1-1/2	1-5/8	1-1/2	2.27	58	
20642-20-16	1-1/4	1-5/8x12	1	4.04	103	2	1-5/8	2	2.50	64	

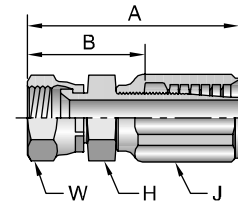

A

B

C

D

E

23742

Female JIC 37° - Swivel - 45° Elbow - Short Drop

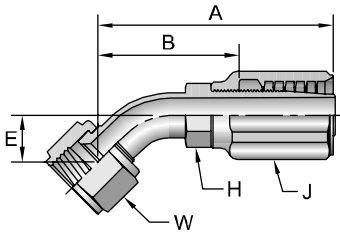

# Part Number	Thread inch	Hose I.D. inch	A		E		H	J	W	B		
			inch	mm	inch	mm	inch	inch	inch	inch	mm	
23742-4-4	1/4	7/16x20	1/4	2.68	68	0.33	8	7/16	11/16	9/16	1.76	45
23742-6-6	3/8	9/16x18	3/8	3.03	77	0.39	10	9/16	7/8	11/16	1.88	48
23742-8-8	1/2	3/4x16	1/2	3.46	88	0.55	14	11/16	1	7/8	2.13	54
23742-16-16	1	1-5/16x12	1	4.38	111	0.90	23	1-1/4	1-5/8	1-1/2	2.84	72

23942

Female JIC 37° - Swivel - 90° Elbow - Short Drop

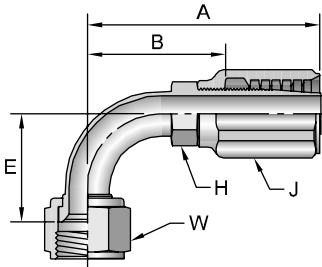

# Part Number	Thread inch	Hose I.D. inch	A		E		H	J	W	B		
			inch	mm	inch	mm	inch	inch	inch	inch	mm	
23942-4-4	1/4	7/16x20	1/4	2.50	64	0.83	21	7/16	11/16	9/16	1.58	40
23942-6-6	3/8	9/16x18	3/8	2.93	74	0.85	22	9/16	7/8	11/16	1.78	45
23942-8-6	1/2	3/4x16	3/8	3.06	78	1.09	28	11/16	7/8	7/8	1.91	49
23942-8-8	1/2	3/4x16	1/2	3.22	82	1.09	28	11/16	1	7/8	1.90	48
23942-10-8	5/8	7/8x14	1/2	3.37	86	1.24	31	13/16	1	1	2.04	52
23942-12-12	3/4	1-1/16x12	3/4	3.89	99	1.81	46	15/16	1-3/8	1-1/4	2.41	61
23942-16-16	1	1-5/16x12	1	4.35	110	2.14	54	1-1/4	1-5/8	1-1/2	2.81	71

24142

Female JIC 37° - Swivel - 90° Elbow - Long Drop

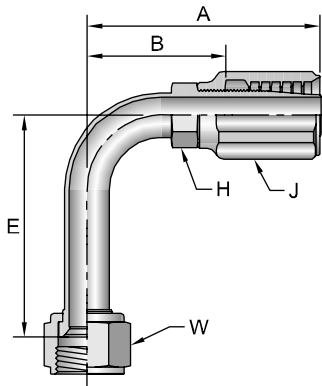

# Part Number	Thread inch	Hose I.D. inch	A		E		H	J	W	B		
			inch	mm	inch	mm	inch	inch	inch	inch	mm	
24142-6-6	3/8	9/16x18	3/8	2.92	74	2.18	55	9/16	7/8	11/16	1.77	45
24142-8-8	1/2	3/4x16	1/2	3.30	84	2.43	62	11/16	1	7/8	1.97	50
24142-10-8	5/8	7/8x14	1/2	3.44	87	2.57	65	13/16	1	1	2.11	54

20842

Female SAE 45° - Swivel

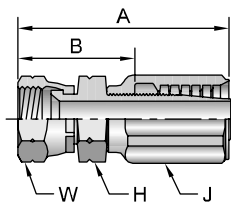

# Part Number	Thread inch	Hose I.D. inch	A		H	J	W	B		
			inch	mm	inch	inch	inch	inch	mm	
20842-6-6	3/8	5/8x18	3/8	2.82	72	3/4	7/8	3/4	1.67	42

Notch on nut signifies SAE 45° flare.

2JS42

Female Seal-Lok® - Swivel - Long

ISO - 12151-1 - SWSB

# Part Number	Thread		Hose I.D. inch	A		H inch	J inch	W inch	B	
	inch	inch		inch	mm				inch	mm
2JS42-4-4	1/4	9/16-18	1/4	2.60	66	9/16	11/16	11/16	1.68	43
2JS42-6-6	3/8	11/16x16	3/8	2.91	74	9/16	7/8	13/16	1.76	45
2JS42-8-8	1/2	13/16x16	1/2	3.23	82	11/16	1	15/16	1.90	48

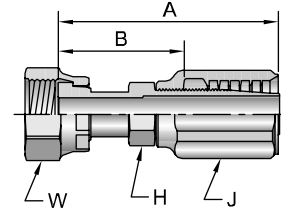

2J942

Female Seal-Lok® - Swivel - 90° Elbow - Short Drop

ISO 12151-1 - SWES90

# Part Number	Thread		Hose I.D. inch	A		E		H inch	J inch	W inch	B	
	inch	inch		inch	mm	inch	mm				inch	mm
2J942-4-4	1/4	9/16x18	1/4	2.81	71	0.78	20	7/16	11/16	11/16	1.89	48
2J942-6-6	3/8	11/16x16	3/8	2.93	74	0.90	23	9/16	7/8	13/16	1.78	45
2J942-8-8	1/2	13/16x16	1/2	3.22	82	1.15	29	11/16	1	15/16	1.89	48

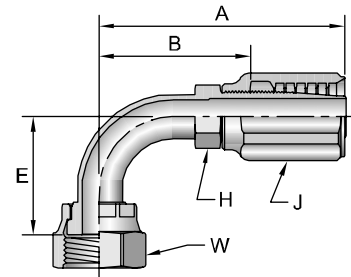

Metric L: Mates with EO "L" Series Fittings.
See Accessories Section for O-Rings.

42 Series

Hose Assembly Instructions

A

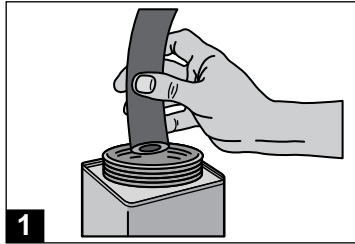

1. Identify over all length (OAL) of hose assembly and the cut off allowance (COA) length of fitting(s) on hose ends by use of the fitting data table. Properly measure, mark and cut hose to desired length using fine tooth hacksaw or a cutoff machine. Dip hose end into Hoze-Oil (See Section C) or heavy oil.

B

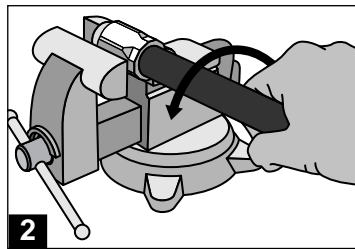

2. Place socket in vice and screw in hose counter-clockwise until hose bottoms. Back hose out 1/2 turn.

C

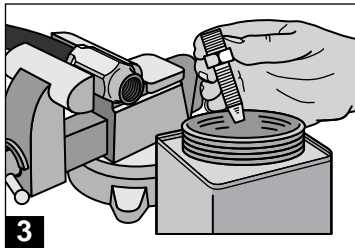

3. Dip hose end of nipple into Hoze-Oil or other heavy oil up to the hex. When assembling fittings of 316 stainless steel lubricate the threads of both the socket and nipple with Dow Corning Molykote G-n or equivalent metal assembly lubricant.

4. Screw assembly into socket using wrench on nipple hex until nipple hex shoulders against socket.

Note: Disassemble in reverse order.

IF YOU HAVE QUESTIONS CONCERNING THE PRODUCTS
OR APPLICATION OF THE PRODUCTS CONTAINED IN THIS

CATALOG, PLEASE CALL:

PARKER HOSE PRODUCTS DIVISION
TECHNICAL SERVICES DEPARTMENT

PHONE: 440 / 943-5700

FAX: 440 / 943-3129

<http://www.parkerhose.com>

D

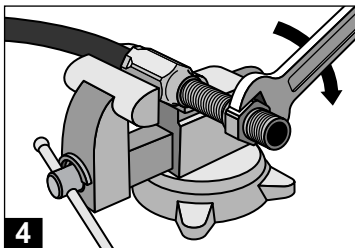

E











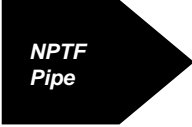







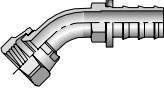
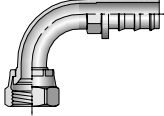



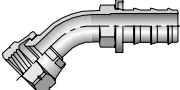
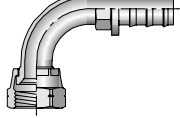

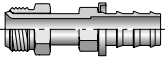
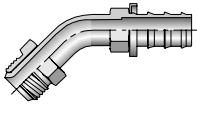
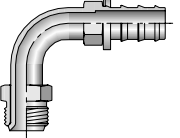

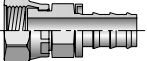

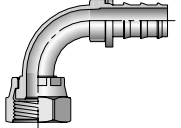
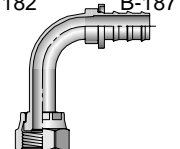

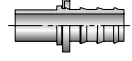

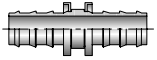

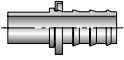
A

B

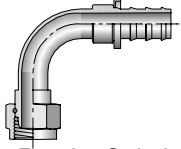
C

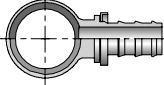
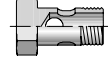
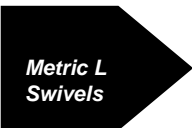
D

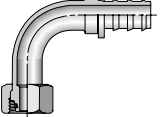
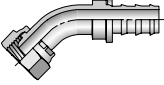
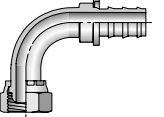
E

A		30182 B-182  Male - Rigid	31382 B-182  Male - Swivel	30282 B-183  Female - Rigid		37G82 B-183  Female - Swivel Gasket Joint
		30382 B-183  Male - Rigid	30682 B-184  Female - Swivel	33782 B-184  Female - Swivel 45° Elbow - Short	33982 B-184  Female - Swivel 90° Elbow - Short	34182 B-184  Female - Swivel 90° Elbow - Long
B		30482 B-185  Male - Rigid	30882 B-185  Female - Swivel	37782 B-185  Female - Swivel 45° Elbow	37982 B-185  Female - Swivel 90° Elbow	
	32882 B-186  Male - Swivel	36782 B-186  Male - Swivel 45° Elbow	36982 B-186  Male - Swivel 90° Elbow	32982 B-186  Female - Rigid		3JC82 B-187  Female - Swivel Short
C	3J782 B-187  Female - Swivel 45° Elbow	3J982 B-187  Female - Swivel 90° Elbow - Short	3J182 B-187  Female - Swivel 90° Elbow - Long		33482 B-188  Male - Rigid	
D	38282 B-188  Push-Lok Union		3D082 B-188  Male - Rigid	31D82 B-189  Male Standpipe Rigid		39282 B-189  Female - Swivel
E	3D982 B-189  Male - Rigid	3B282 B-189  Female - Swivel 90° Elbow		34982 B-190  Metric - Banjo	AM B-190  Banjo Bolt	
	3CA82 B-191  Swivel - 24° Cone	3CF82 B-191  Swivel - 90° Elbow - 24° Cone	3C482 B-191  Swivel - 45° Elbow - Ball Nose	3C582 B-192  Swivel - 90° Elbow - Ball Nose	3C382 B-192  Swivel - Ball Nose	

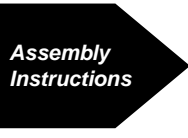
Push-Lok Kits B-193 <i>Push-Lok Hose and Fitting Kits</i>	Push-Lok Merchandiser B-194 <i>Push-Lok Hose and Fitting Display Case</i>		82 Series Assembly Instructions B-195
---	---	---	--

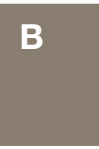
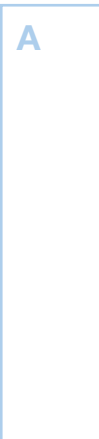

30182 Male NPTF Pipe - Rigid

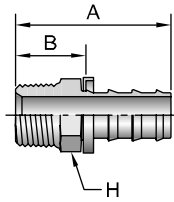

# Part Number	Thread inch	Hose I.D. inch	A		H	B		Additional Material	
			inch	mm	inch	inch	mm	Brass (B)	Stainless Steel (C)
30182-2-4	1/8x27	1/4	1.39	35	7/16	0.64	16	•	•
30182-4-4	1/4x18	1/4	1.57	40	9/16	0.82	21	•	•
30182-4-6	1/4x18	3/8	1.78	45	9/16	0.88	22	•	•
30182-4-8	1/4x18	1/2	1.93	49	5/8	0.88	22	•	•
30182-6-6	3/8x18	3/8	1.78	45	11/16	0.88	22	•	•
30182-6-8	3/8x18	1/2	1.93	49	11/16	0.88	22	•	•
30182-8-6	1/2x14	3/8	2.03	52	7/8	1.13	29	•	•
30182-8-8	1/2x14	1/2	2.18	55	7/8	1.13	29	•	•
30182-8-10	1/2x14	5/8	2.58	66	7/8	1.13	29	•	•
30182-8-12	1/2x14	3/4	2.58	66	7/8	1.13	29	•	•
30182-12-8	3/4x14	1/2	2.21	56	3/4	1.16	29	•	•
30182-12-10	3/4x14	5/8	2.61	66	1-1/16	1.16	29	•	•
30182-12-12	3/4x14	3/4	2.61	66	1-1/16	1.16	29	•	•
30182-16-16	1x11-1/2	1	3.06	78	1-3/8	1.61	41	•	•

31382 Male NPTF Pipe - Swivel

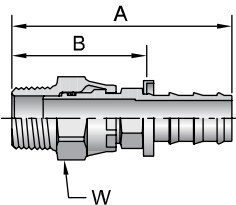

# Part Number	Thread inch	Hose I.D. inch	A		W	B		Additional Material Brass (B)
			inch	mm	inch	inch	mm	
31382-4-4	1/4x18	1/4	1.60	41	9/16	0.85	22	
31382-6-6	3/8x18	3/8	1.79	45	11/16	0.89	23	
31382-8-8	1/2x14	1/2	2.20	56	7/8	1.15	29	
31382-8-10	1/2x14	5/8	3.50	90	7/8	2.05	52	•
31382-12-12	3/4x14	3/4	3.70	94	1-1/4	2.25	57	

O-Ring not compatible with Phosphate Ester fluids.

30282

Female NPTF Pipe - Rigid

# Part Number	Thread inch	Hose I.D. inch	A		H	B		Additional Material Brass (B)
			inch	mm	inch	inch	mm	
30282-4-4	1/4x18	1/4	1.56	40	3/4	0.81	21	•
30282-6-6	3/8x18	3/8	1.82	46	7/8	0.92	23	•
30282-8-8	1/2x14	1/2	2.16	55	1-1/16	1.11	28	•

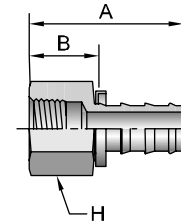

37G82

Female NPSM Pipe - Gasket Joint - Swivel

# Part Number	Gasket	Thread inch	Hose I.D. inch	A		W	B	
				inch	mm	inch	inch	mm
37G82-4-4	07G-4	1/4x18	1/4	1.55	39	11/16	0.80	20
37G82-4-6	07G-4	1/4x18	3/8	1.70	43	11/16	0.80	20
37G82-6-6	07G-6	3/8x18	3/8	1.75	44	7/8	0.85	22
37G82-8-8	07G-8	1/2x14	1/2	2.07	53	1	1.02	26
37G82-8-10	07G-8	1/2x14	5/8	2.47	63	1	1.02	26
37G82-12-12	07G-12	3/4x14	3/4	2.54	65	1-1/4	1.09	28

Textile gasket included with fitting.

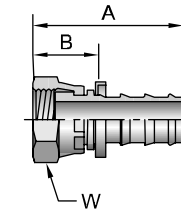

30382

Male JIC 37° - Rigid

# Part Number	Thread inch	Hose I.D. inch	A		H	B		Additional Material Brass (B)
			inch	mm	inch	inch	mm	
30382-4-4	1/4 7/16x20	1/4	1.56	40	1/2	0.81	21	
30382-5-4	5/16 1/2x20	1/4	1.59	40	9/16	0.84	21	
30382-6-6	3/8 9/16x18	3/8	1.78	45	5/8	0.88	22	•
30382-8-8	1/2 3/4x16	1/2	2.06	52	3/4	1.01	26	
30382-10-10	5/8 7/8x14	5/8	2.62	67	7/8	1.17	30	
30382-12-12	3/4 1-1/16x12	3/4	2.72	69	1-1/8	1.27	32	

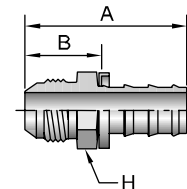

A

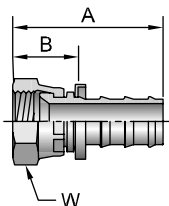

30682 Female JIC 37° - Swivel

# Part Number	Thread		Hose I.D. inch	A		W inch	B		Additional Material	
	inch	mm		inch	mm		inch	mm	Brass (B)	Stainless Steel (C)
30682-4-4	1/4	7/16x20	1/4	1.52	39	9/16	0.77	20	•	•
30682-5-4	5/16	1/2x20	1/4	1.58	40	5/8	0.83	21	•	
30682-5-6	5/8	1/2x20	3/8	1.72	44	5/8	0.82	21	•	
30682-6-4	3/8	9/16x18	1/4	1.61	41	11/16	0.86	22	•	
30682-6-6	3/8	9/16x18	3/8	1.75	44	11/16	0.85	22	•	•
30682-6-8	3/8	9/16x18	1/2	1.90	48	11/16	0.85	22	•	
30682-8-6	1/2	3/4x16	3/8	1.87	47	7/8	0.97	25	•	
30682-8-8	1/2	3/4x16	1/2	2.02	51	7/8	0.97	25	•	•
30682-10-8	5/8	7/8x14	1/2	2.14	54	1	1.09	28	•	
30682-10-10	5/8	7/8x14	5/8	2.54	65	1	1.09	28	•	•
30682-12-12	3/4	1-1/16x12	3/4	2.65	67	1-1/4	1.20	30	•	•
30682-16-16	1	1-5/16x12	1	2.77	70	1-1/2	1.32	34	•	

B

33782 Female JIC 37° - Swivel - 45° Elbow - Short Drop

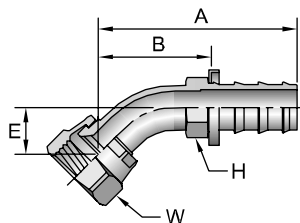

# Part Number	Thread		Hose I.D. inch	A		E		H	W	B	
	inch	mm		inch	mm	inch	mm	inch	mm	inch	mm
33782-4-4	1/4	7/16x20	1/4	1.74	44	0.39	10	7/16	9/16	0.99	25
33782-6-6	3/8	9/16x18	3/8	1.99	51	0.43	11	1/2	11/16	1.09	28
33782-8-8	1/2	3/4x16	1/2	2.58	66	0.55	14	5/8	7/8	1.53	39
33782-10-10	5/8	7/8x14	5/8	3.03	77	0.65	17	3/4	1	1.58	40

C

D

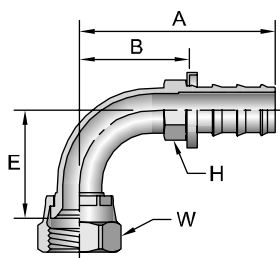

33982 Female JIC 37° - Swivel - 90° Elbow - Short Drop

# Part Number	Thread		Hose I.D. inch	A		E		H	W	B	
	inch	mm		inch	mm	inch	mm	inch	mm	inch	mm
33982-4-4	1/4	7/16x20	1/4	1.55	39	0.83	21	---	9/16	0.80	20
33982-6-6	3/8	9/16x18	3/8	1.85	47	0.91	23	---	11/16	0.95	24
33982-8-8	1/2	3/4x16	1/2	2.33	59	1.09	28	5/8	7/8	1.28	33
33982-10-10	5/8	7/8x14	5/8	2.88	73	1.24	31	3/4	1	1.43	36
33982-12-12	3/4	1-1/16x12	3/4	3.26	83	1.81	46	7/8	1-1/4	1.81	46

E

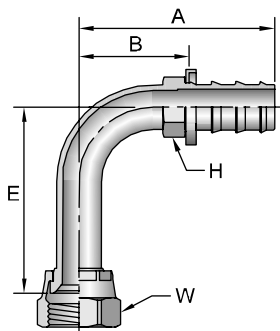

34182 Female JIC 37° - Swivel - 90° Elbow - Long Drop

# Part Number	Thread		Hose I.D. inch	A		E		H	W	B	
	inch	mm		inch	mm	inch	mm	inch	mm	inch	mm
34182-4-4	1/4	7/16x20	1/4	1.79	45	1.80	46	7/16	9/16	1.04	26
34182-6-6	3/8	9/16x18	3/8	1.97	50	2.18	55	1/2	11/16	1.07	27

30482 Male SAE 45° - Rigid

# Part Number	Thread		Hose I.D. inch	A		H inch	B	
	inch	mm		inch	mm		inch	mm
30482-4-4B	1/4	7/16x20	1/4	1.51	38	7/16	0.76	19
30482-5-4B	5/16	1/2x20	1/4	1.61	41	9/16	0.86	22
30482-6-6B	3/8	5/8x18	3/8	1.84	47	5/8	0.94	24
30482-8-8B	1/2	3/4x16	1/2	2.15	55	3/4	1.10	28

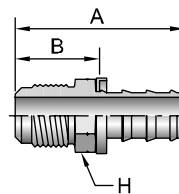

30882 Female SAE 45° - Swivel

# Part Number	Thread		Hose I.D. inch	A		W inch	B		Additional Material Brass (B)
	inch	mm		inch	mm		inch	mm	
30882-4-4	1/4	7/16x20	1/4	1.52	39	9/16	0.77	20	•
30882-5-4	5/16	1/2x20	1/4	1.58	40	5/8	0.83	21	•
30882-6-6	3/8	5/8x18	3/8	1.81	46	3/4	0.91	23	•
30882-8-6	1/2	3/4x16	3/8	1.87	47	7/8	0.97	25	•
30882-8-8	1/2	3/4x16	1/2	2.02	51	7/8	0.97	25	•
30882-10-10	5/8	7/8x14	5/8	2.54	65	1	1.09	28	•
30882-12-12	3/4	1-1/16x14	3/4	2.65	67	1-1/4	1.20	30	•

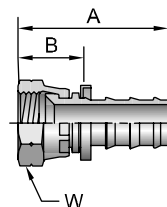

37782 Female SAE 45° - Swivel - 45° Elbow

# Part Number	Thread		Hose I.D. inch	A		E		H inch	W inch	B	
	inch	mm		inch	mm	inch	mm			inch	mm
37782-4-4	1/4	7/16x20	1/4	1.79	45	0.33	8	7/16	9/16	1.04	26
37782-6-6	3/8	5/8x18	3/8	2.08	53	0.39	10	1/2	3/4	1.18	30
37782-8-8	1/2	3/4x16	1/2	2.58	66	0.55	14	5/8	7/8	1.53	39

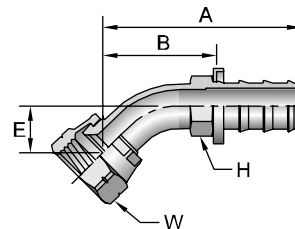

37982 Female SAE 45° - Swivel - 90° Elbow

# Part Number	Thread		Hose I.D. inch	A		E		H inch	W inch	B	
	inch	mm		inch	mm	inch	mm			inch	mm
37982-4-4	1/4	7/16x20	1/4	1.60	41	0.83	21	7/16	9/16	0.85	22
37982-6-6	3/8	5/8x18	3/8	1.98	50	0.85	22	1/2	3/4	1.08	27
37982-8-8	1/2	3/4x16	1/2	2.33	59	1.09	28	5/8	7/8	1.28	33

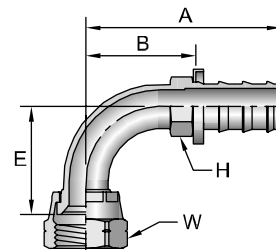

Notch in nut signifies 45° flare.

32882 Male Inverted SAE 45° - Swivel

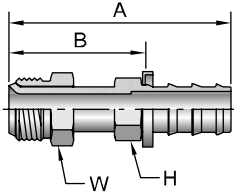

# Part Number	Thread inch		Hose I.D. inch	A inch mm		H inch	W inch	B inch mm	
32882-3-4	3/16	3/8x24	1/4	2.15	55	3/8	3/8	1.40	36
32882-4-4	1/4	7/16x24	1/4	2.15	55	7/16	7/16	1.40	36
32882-5-4	5/16	1/2x20	1/4	2.31	59	7/16	1/2	1.56	40
32882-6-6	3/8	5/8x18	3/8	2.58	66	1/2	5/8	1.68	43
32882-8-8	1/2	3/4x18	1/2	2.82	72	5/8	3/4	1.77	45
32882-10-10	5/8	7/8x18	5/8	3.34	85	3/4	7/8	1.89	48

36782 Male Inverted SAE 45° - Swivel - 45° Elbow

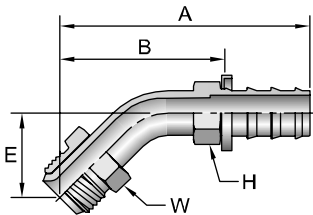

# Part Number	Thread inch		Hose I.D. inch	A inch mm		E inch mm		H inch	W inch	B inch mm	
36782-4-4	1/4	7/16x24	1/4	1.92	49	0.63	16	7/16	7/16	1.17	30
36782-6-6	3/8	5/8x18	3/8	2.64	67	0.94	24	1/2	5/8	1.74	44

36982 Male Inverted SAE 45° - Swivel - 90° Elbow

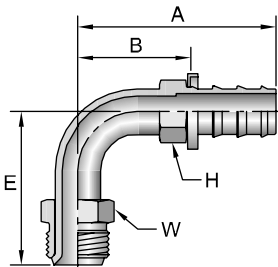

# Part Number	Thread inch		Hose I.D. inch	A inch mm		E inch mm		H inch	W inch	B inch mm	
36982-4-4	1/4	7/16x24	1/4	1.99	51	1.56	40	7/16	7/16	1.24	31
36982-5-4	5/16	1/2x20	1/4	2.17	55	1.65	42	7/16	1/2	1.42	36
36982-6-6	3/8	5/8x18	3/8	2.30	58	1.69	43	1/2	5/8	1.40	36

32982 Female Inverted SAE 45° - Rigid

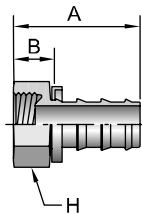

# Part Number	Thread inch		Hose I.D. inch	A inch mm		H inch	B inch mm	
32982-4-4B	1/4	7/16x24	1/4	1.19	30	1/2	0.44	11
32982-5-4B	5/16	1/2x20	1/4	1.25	32	9/16	0.50	13
32982-6-6B	3/8	5/8x18	3/8	1.44	37	3/4	0.54	14
32982-8-8B	1/2	3/4x18	1/2	1.62	41	7/8	0.57	14

3JC82

Female Seal-Lok® - Swivel - Short
ISO 12151-1 - SWSA

# Part Number	Thread		Hose I.D. inch	A		C		H inch	W inch	B		Additional Material	
	inch	9/16x18		inch	mm	inch	mm			inch	mm	Brass (B)	Stainless Steel (C)
3JC82-4-4	1/4	9/16x18	1/4	1.40	36	0.32	8	9/16	11/16	0.65	17		•
3JC82-6-6	3/8	11/16x16	3/8	1.59	40	0.38	10	11/16	13/16	0.69	18		•
3JC82-6-6SM	3/8	11/16x16	3/8	1.59	40	0.38	10	19mm	22mm	0.69	18		
3JC82-8-6	1/2	13/16x16	3/8	1.65	42	0.38	10	13/16	15/16	0.76	19		
3JC82-8-8	1/2	13/16x16	1/2	1.80	46	0.43	11	13/16	15/16	0.75	19		•
3JC82-10-10	5/8	1x14	5/8	2.40	61	0.53	13	15/16	1-1/8	0.95	24		
3JC82-12-12	3/4	1-3/16x12	3/4	2.63	67	0.57	14	1-1/8	1-3/8	1.18	30		•
3JC82-16-16	1	1-7/16x12	1	2.61	66	0.58	15	1-3/8	1-5/8	1.16	29	•	•

When measuring overall length to the end of the nut, B+C dimensions must be used to calculate cut-off allowance.

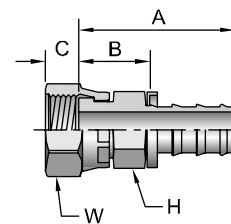

3J782

Female Seal-Lok® - Swivel - 45° Elbow
ISO 12151-1 - SWE45

# Part Number	Thread		Hose I.D. inch	A		E		W inch	B	
	inch	9/16x18		inch	mm	inch	mm		inch	mm
3J782-4-4	1/4	9/16x18	1/4	1.74	44	0.39	10	11/16	0.99	25
3J782-6-6	3/8	11/16x16	3/8	1.99	51	0.43	11	13/16	1.09	28
3J782-8-8	1/2	13/16x16	1/2	2.41	61	0.59	15	15/16	1.36	35

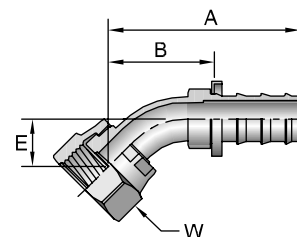

3J982

Female Seal-Lok® - Swivel - 90° Elbow - Short Drop
ISO 12151-1 - SWES90

# Part Number	Thread		Hose I.D. inch	A		E		W inch	B	
	inch	9/16x18		inch	mm	inch	mm		inch	mm
3J982-4-4	1/4	9/16x18	1/4	1.55	39	0.83	21	11/16	0.80	20
3J982-6-6	3/8	11/16x16	3/8	1.85	47	0.91	23	13/16	0.95	24
3J982-6-8	3/8	11/16x16	1/2	2.09	53	0.91	23	13/16	1.04	26
3J982-8-6	1/2	13/16x16	3/8	1.94	49	1.14	29	15/16	1.04	26
3J982-8-8	1/2	13/16x16	1/2	2.16	55	1.14	29	15/16	1.11	28
3J982-10-10	5/8	1x14	5/8	2.76	70	1.26	32	1-1/8	1.31	33
3J982-12-12	3/4	1-3/6x12	3/4	3.27	83	1.89	48	1-3/8	1.82	46

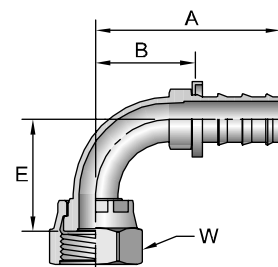

3J182

Female Seal-Lok® - Swivel - 90° Elbow - Long Drop
ISO 12151-1 - SWEL90

# Part Number	Thread		Hose I.D. inch	A		E		W inch	B	
	inch	11/16x16		inch	mm	inch	mm		inch	mm
3J182-6-6	3/8	11/16x16	3/8	1.85	47	2.13	54	13/16	0.95	24
3J182-8-8	1/2	13/16x16	1/2	2.16	55	2.52	64	15/16	1.11	28

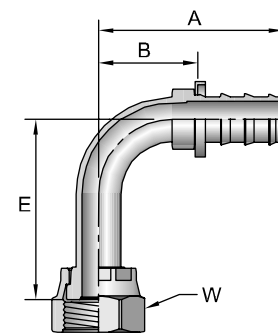

See Accessories Section for O-Rings.

33482

Male Standpipe - Rigid - (Inch Size Tube O.D.)

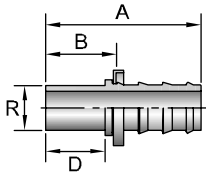

# Part Number	R inch	Hose I.D. inch	A		D		B		Additional Material	
			inch	mm	inch	mm	inch	mm	Brass (B)	Stainless Steel (C)
33482-4-4	1/4	1/4	1.89	48	1.02	26	1.14	29	•	•
33482-5-4	5/16	1/4	1.93	49	1.08	27	1.18	30	•	
33482-6-6	3/8	3/8	2.23	57	1.22	31	1.33	34	•	•
33482-8-8	1/2	1/2	2.16	55	0.97	25	1.11	28	•	•
33482-10-10	5/8	5/8	2.62	67	1.00	25	1.17	30	•	
33482-12-12	3/4	3/4	2.62	67	1.00	25	1.17	30	•	•

38282

Push-Lok Union

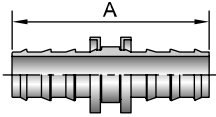

# Part Number	Hose I.D. inch	A		Additional Material Brass (B)
		inch	mm	
38282-4-4	1/4	1.80	46	•
38282-6-6	3/8	2.15	55	•
38282-8-8	1/2	2.51	64	•
38282-10-10	5/8	3.31	84	•
38282-12-12	3/4	3.31	84	•
38282-16-16	1	3.31	84	•

3D082

Male Metric L - Rigid - (24° Cone)

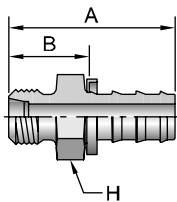

# Part Number	Thread		Hose I.D. inch	A		H mm	B	
	mm			inch	mm		inch	mm
3D082-6-4	6	M12x1,5	1/4	1.34	34	12	0.55	14
3D082-8-4	8	M14x1,5	1/4	1.38	35	14	0.59	15
3D082-10-6	10	M16x1,5	3/8	1.57	40	17	0.63	16
3D082-12-6	12	M18x1,5	3/8	1.61	41	19	0.67	17

31D82

Male Standpipe Metric L - Rigid

# Part Number	R mm	Hose I.D. inch	A		D		B	
			inch	mm	inch	mm	inch	mm
31D82-6-4	6	1/4	1.73	44	0.87	22	0.98	25
31D82-8-4	8	1/4	1.73	44	0.87	22	0.98	25
31D82-10-6	10	3/8	1.93	49	0.91	23	1.02	26
31D82-12-6	12	3/8	1.93	49	0.91	23	1.06	27
31D82-15-8	15	1/2	2.17	55	0.98	25	1.10	28
31D82-18-10	18	5/8	2.64	67	1.02	26	1.10	28
31D82-22-12	22	3/4	2.72	69	1.10	28	1.22	31

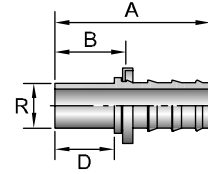

39282

Female BSP Parallel Pipe - Swivel - (60° Cone)

# Part Number	Thread inch	Hose I.D. inch	A		C		W		B		Additional Material Brass (B)
			inch	mm	inch	mm	mm	inch	mm		
39282-4-4	1/4x19	1/4	1.34	34	0.22	6	17	0.55	14		
39282-6-6	3/8x19	3/8	1.50	38	0.26	7	19	0.55	14	•	
39282-8-8	1/2x14	1/2	1.77	45	0.28	7	27	1.06	27		
39282-12-12	3/4x14	3/4	2.13	54	0.35	9	36	1.42	36		

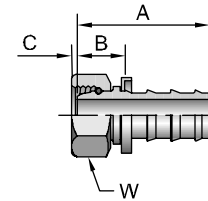

When measuring overall length to the end of the nut, B + C dimensions must be used to calculate cut-off allowances.

3D982

Male BSP Parallel Pipe - Rigid - (60° Cone)

# Part Number	Hose I.D. inch	A		H		B	
		inch	mm	mm	inch	mm	
3D982-2-4	1/4	1.42	36	14	0.63	16	
3D982-4-4	1/4	1.61	41	19	0.83	21	
3D982-4-6	3/8	1.77	45	19	0.83	21	
3D982-6-6	3/8	1.77	45	22	0.87	22	
3D982-8-8	1/2	2.09	53	27	0.98	25	
3D982-8-10	5/8	2.44	62	27	0.94	24	
3D982-12-12	3/4	2.56	65	32	1.06	27	

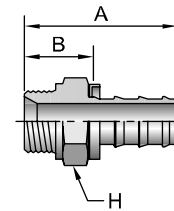

Bonded seal required if fitting is used directly in a port. See Accessories Section.

3B282

Female BSP Parallel Pipe - Swivel - 90° Elbow - (60° Cone)

# Part Number	Thread inch	Hose I.D. inch	A		E		W		B	
			inch	mm	inch	mm	mm	inch	mm	
3B282-4-4	1/4x19	1/4	1.65	42	1.02	26	17	1.02	26	
3B282-6-6	3/8x19	3/8	2.09	53	1.18	30	19	1.18	30	
3B282-8-8	1/2x14	1/2	2.56	65	1.57	40	27	1.57	40	
3B282-10-10	5/8x14	5/8	2.99	76	1.57	40	30	1.57	40	

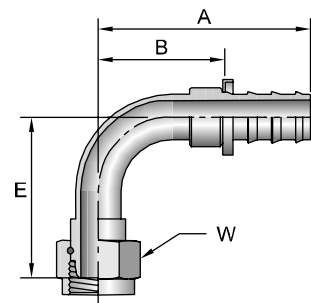

34982 DIN Metric Banjo

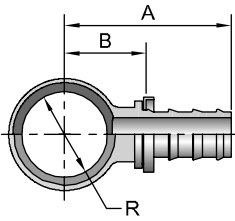

# Part Number	Hose I.D.		A		B	
	R mm	inch	inch	mm	inch	mm
34982-8-4	8	1/4	1.42	36	0.63	16
34982-10-4	10	1/4	1.50	38	0.71	18
34982-12-4	12	1/4	1.57	40	0.79	20
34982-12-6	12	3/8	1.73	44	0.79	20
34982-14-4	14	1/4	1.65	42	0.87	22
34982-14-6	14	3/8	1.85	47	0.91	23
34982-16-6	16	3/8	1.93	49	0.98	25
34982-18-8	18	1/2	2.17	55	1.06	27

AM Banjo Bolt with DIN Metric Thread

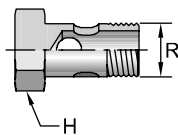

# Part Number	R Thread mm	H mm	Copper Washer (2)
AM-03	8 M8x1	12	853009-8
AM-04	10 M10x1	14	853009-10
AM-06	12 M12x1.5	17	853009-12
AM-08	14 M14x1.5	19	853009-14
AM-10	16 M16x1.5	22	853009-16
AM-13	18 M18x1.5	24	853009-18
AM-16	22 M22x1.5	27	853009-22
AM-20	26 M26x1.5	32	853009-26
AM-30	30 M30x1.5	36	853009-30

Two (2) copper washers per bolt must be ordered separately.

3CA82

Female Metric L - Swivel - (24° Cone with O-Ring)

ISO 12151-2 - SWS

# Part Number	Thread		Hose I.D. inch	A		W mm	B	
	inch	M		inch	mm		inch	mm
3CA82-8-4	8	M14x1,5	1/4	1.42	36	17	0.67	17
3CA82-10-6	10	M16x1,5	3/8	1.57	40	19	0.67	17
3CA82-10-6B	10	M16x1,5	3/8	1.57	40	19	0.67	17
3CA82-12-6	12	M18x1,5	3/8	1.57	40	22	0.67	17
3CA82-15-8	15	M22x1,5	1/2	1.73	44	27	0.71	18
3CA82-22-12	22	M30x2	3/4	2.28	58	36	0.83	21

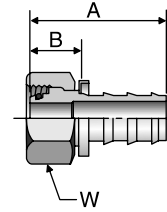

3CF82

Female Metric L - Swivel - 90° Elbow - (24° Cone with O-Ring)

ISO 12151-2 - SWE

# Part Number	Thread		Hose I.D. inch	A		E		W mm	B	
	inch	M		inch	mm	inch	mm		inch	mm
3CF82-8-4	8	M14x1,5	1/4	1.65	42	1.26	32	17	0.91	23
3CF82-10-6	10	M16x1,5	3/8	1.93	49	1.38	35	19	1.06	27
3CF82-10-6B	10	M16x1,5	3/8	1.93	49	1.38	35	19	1.06	27
3CF82-12-6	12	M18x1,5	3/8	1.93	49	1.42	36	22	1.06	27
3CF82-15-8	15	M22x1,5	1/2	2.28	58	1.61	41	27	1.26	32
3CF82-22-12	22	M30x2	3/4	3.46	88	2.17	55	36	2.01	51

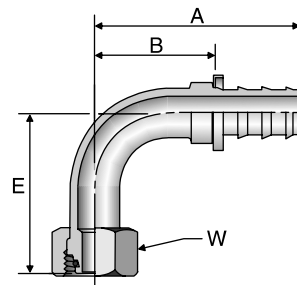

3C482

Female Metric L - Swivel - 45° Elbow - (Ball Nose)

End Connection per ISO 8434-1-SWOE

# Part Number	Thread		Hose I.D. inch	A		E		W mm	B	
	inch	M		inch	mm	inch	mm		inch	mm
3C482-8-4B	8	M14x1,5	1/4	2.01	51	0.63	16	17	1.26	32
3C482-10-6B	10	M16x1,5	3/8	2.28	58	0.71	18	19	1.38	35
3C482-15-8B	15	M22x1,5	1/2	2.68	68	0.75	19	27	1.61	41
3C482-22-12	22	M30x2	3/4	3.46	88	0.91	23	36	2.05	52

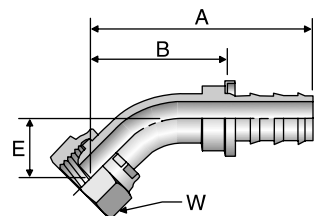

3C582

Female Metric L - Swivel - 90° Elbow - (Ball Nose)

End Connection per ISO 8434-1-SWOF

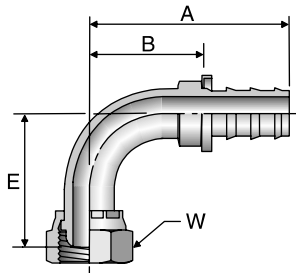

# Part Number	Thread inch	Hose I.D. inch	A		E		W mm	B	
			inch	mm	inch	mm		inch	mm
3C582-8-4B	8 M14x1,5	1/4	1.65	42	1.14	29	17	0.91	23
3C582-10-6B	10 M16x1,5	3/8	1.93	49	1.30	33	19	1.06	27
3C582-15-8B	15 M22x1,5	1/2	2.36	60	1.54	39	27	1.34	34
3C582-22-12B	22 M30x2	3/4	3.46	88	1.97	50	36	2.01	51

3C382

Female Metric L - Swivel - (Ball Nose)

End Connection per ISO 8434-1-SWOS

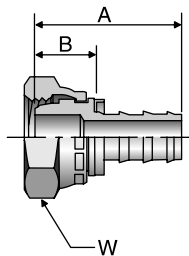

# Part Number	Thread inch	Hose I.D. inch	A		W mm	B	
			inch	mm		inch	mm
3C382-8-4B	8 M14x1,5	1/4	1.42	36	19	0.63	16
3C382-10-6B	10 M16x1,5	3/8	1.50	38	19	0.59	15
3C382-15-8B	15 M22x1,5	1/2	1.65	42	27	0.59	15
3C382-22-12B	22 M30x2	3/4	2.09	53	36	0.67	17

Parker Push-Lok® Kits

Parker Push-Lok Kits are for industrial and automotive maintenance and repair shops. They provide a low-cost inventory of Push-Lok hose and fittings packaged in a sturdy metal container. They save time and money on hose line replacements for water, air lubricating oils, anti-freeze solutions and vacuum applications.



Part No. 46-83A

Kit Contents	Quantity	Kit Contents	Quantity
Hose		Male Inverted Swivel	
831-4 (1/4" I.D.)	24 ft.	32882-3-4	3
831-6 (3/8" I.D.)	24 ft.	32882-4-4	5
Male Pipe		32882-5-4	5
30182-2-4B	8	32882-6-6	3
30182-4-4B	5	Female Inverted Rigid	
30182-4-6B	5	32982-3-4B	3
30182-6-6B	6	32982-4-4B	3
Male SAE 45°		32982-5-4B	5
30482-4-4B	2	32982-6-6B	3
30482-6-6B	3	Hose Union	
SAE (JIC) 37° Female Swivel		38282-4-4B	4
30682-6-6B	5	38282-6-6B	2
SAE 45° Swivel			
30882-4-4B	5		
30882-5-4B	5		
30882-6-6B	5		

A

B

C

D

E

Parker Push-Lok® Merchandiser PLM-1 (801 Multi-Purpose Hose)

The Push-Lok® Merchandiser is an ideal method of displaying Push-Lok in will-call areas, maintenance shops, or other areas where air lines are fabricated.

Features

- PLM -1

Hose	Quantity	Size
801-4	300 Feet	1/4" I.D.
801-6	375 Feet	3/8" I.D.
801-8	100 Feet	1/2" I.D.

- 25 each of the following fittings:
 30182-4-4B 30682-4-4B 30882-6-6B
 30182-6-6B 30682-6-6B
 30182-8-8B 30682-8-8B

- Fitting drawers to store up to 18 different styles/sizes of fittings.
- TH11-1 hand held hose cutter.

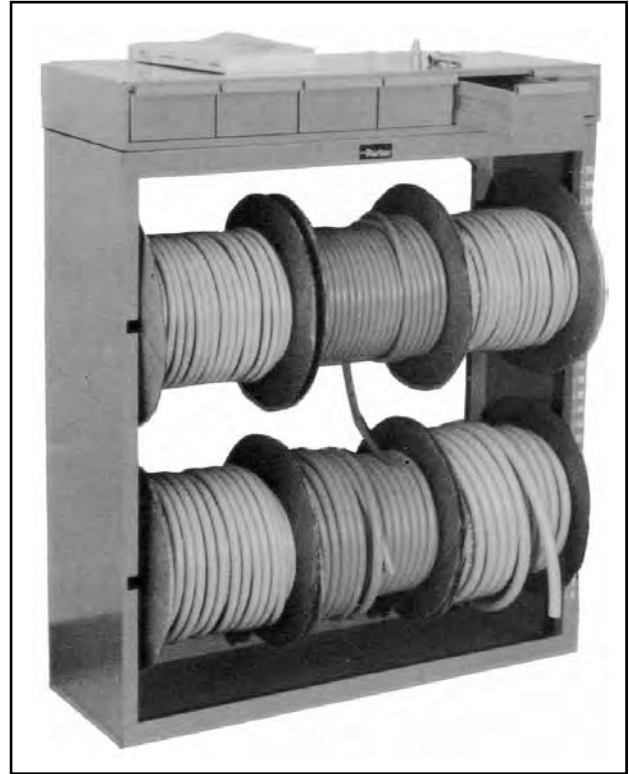

A

B

C

D

E

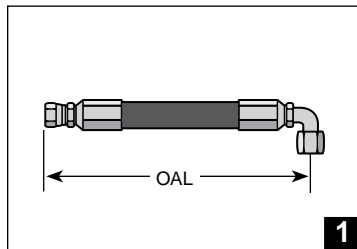

OAL : Straight to 90° Elbow

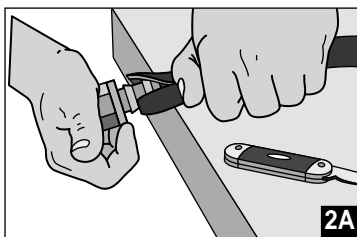
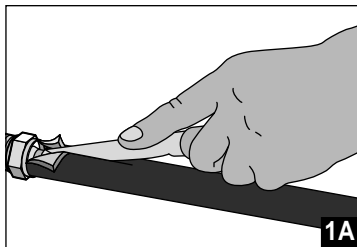
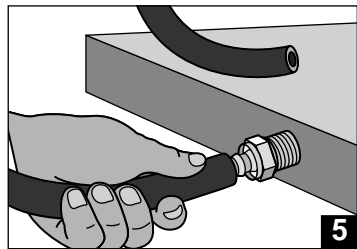

82 Series

Assembly Instructions

1. Identify over all length (OAL) of hose assembly and the cut off allowance (COA) length of fitting(s) on hose ends by use of the fitting data table.
2. Properly measure and mark hose. Cut hose squarely with a Parker Push-Lok cut-off tool or a sharp knife.
3. Lubricate the Push-Lok fitting, hose I.D., or both with light oil or soapy water only - DO NOT USE HEAVY OIL OR GREASE.
4. Insert fitting into hose until first barb is in the hose.
5. Place end fitting against a flat object such as a work bench or wall. Grip hose approximately one inch from end and push with a steady force until the end of the hose is covered by the yellow plastic cap.

Disassembly Instructions

- 1A. Leave fitting in place, and cut hose approximately one inch lengthwise from the yellow plastic cap. **IMPORTANT:** Be careful not to nick barbs when cutting hose.
- 2A. Grip hose firmly and give it a sharp downward tug away from the fitting for disassembly.

Caution: Insert the Push-Lok fitting all the way into the Push-Lok hose until the cut end is concealed by the yellow plastic cap.

Caution: Sealing integrity may be damaged by use of exterior clamps.

IF YOU HAVE QUESTIONS CONCERNING THE PRODUCTS OR APPLICATION OF THE PRODUCTS CONTAINED IN THIS CATALOG, PLEASE CALL:

PARKER HOSE PRODUCTS DIVISION
TECHNICAL SERVICES DEPARTMENT

PHONE: 440 / 943-5700

FAX: 440 / 943-3129

<http://www.parkerhose.com>











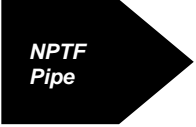
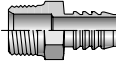
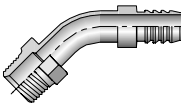
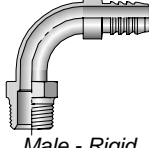



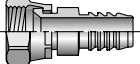
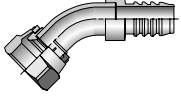
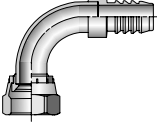

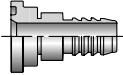

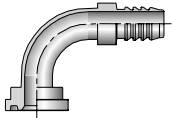

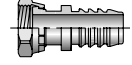
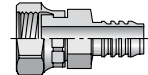
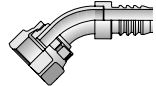
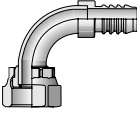
A

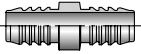
B

C

D

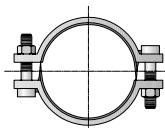
E

 <p>NPTF Pipe</p>	<p>0188 B-198</p>  <p><i>Male - Rigid</i></p>	<p>3188 B-198</p>  <p><i>Male - Rigid 45° Elbow</i></p>	<p>2188 B-198</p>  <p><i>Male - Rigid 90° Elbow</i></p>	 <p>Straight Thread</p>	<p>0588 B-198</p>  <p><i>Male - Rigid</i></p>
 <p>JIC 37°</p>	<p>0688 B-199</p>  <p><i>Female - Swivel</i></p>	<p>3788 B-199</p>  <p><i>Female - Swivel</i></p>	<p>3988 B-199</p>  <p><i>Female - Swivel</i></p>	 <p>Flange</p>	<p>1588 B-199</p>  <p><i>Flange Heads</i></p>
<p>1788 B-200</p>  <p><i>45° Elbow</i></p>	<p>1988 B-200</p>  <p><i>90° Elbow</i></p>	 <p>Seal-Lok® O-Ring Face Seal</p>	<p>JS88 B-200</p>  <p><i>Female - Swivel Long</i></p>	<p>JC88 B-201</p>  <p><i>Female - Swivel Short</i></p>	<p>J788 B-201</p>  <p><i>Female - Swivel 45° Elbow</i></p>
<p>J988 B-201</p>  <p><i>Female - Swivel 90° Elbow</i></p>	 <p>Union</p>	<p>8888 B-202</p>  <p><i>Union</i></p>	 <p>81 Series Crimp Shell</p>	<p>81 Series consists of a 10081 crimp shell and is completed by adding any 88 Series fittings.</p>	<p>10081 B-202</p>  <p><i>81 Series Crimp Shell</i></p>
 <p>Hose Clamp</p>	<p>88HC B-202</p>  <p><i>Hose Clamp</i></p>	<p>88HC-H B-202</p>  <p><i>Hose-Clamp</i></p>	<p>88DB B-202</p>  <p><i>Heavy Duty Clamp</i></p>	 <p>Assembly Instructions</p>	<p>88 Series Assembly Instructions B-203</p>
<p>81 Series Assembly Instructions - See Section C for crimping instructions.</p>					

A

B

C

D

E

A

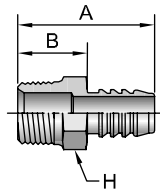

0188 Male NPTF Pipe - Rigid

# Part Number	Thread inch	Hose I.D. inch	A		H inch	B	
			inch	mm		inch	mm
0188-12-12	3/4x14	3/4	2.25	57	1-1/8	1.13	29
0188-16-16	1x11-1/2	1	2.75	70	1-3/8	1.37	35
0188-20-20	1-1/4x11-1/2	1-1/4	3.05	77	1-3/4	1.47	37
0188-20-24	1-1/4x11-1/2	1-1/2	3.21	82	1-3/4	1.47	37
0188-24-24	1-1/2x11-1/2	1-1/2	3.24	82	2	1.50	38
0188-32-32	2x11-1/2	2	3.49	89	2-1/2	1.66	42
0188-40-40	2-1/2x8	2-1/2	4.10	104	3	2.27	58

B

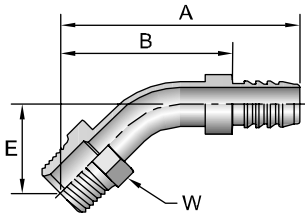

3188 Male NPTF Pipe - Rigid - 45° Elbow

# Part Number	Thread inch	Hose I.D. inch	A		E		W inch	B	
			inch	mm	inch	mm		inch	mm
3188-16-16	1x11-1/2	1	4.12	105	1.63	41	1-3/8	2.74	70
3188-20-20	1-1/4x11-1/2	1-1/4	4.54	115	1.77	45	1-3/4	2.96	75

C

2188 Male NPTF Pipe - Rigid - 90° Elbow

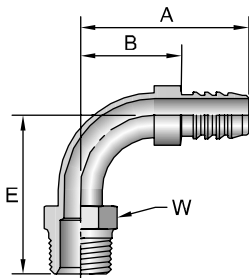

# Part Number	Thread inch	Hose I.D. inch	A		E		W inch	B	
			inch	mm	inch	mm		inch	mm
2188-12-12	3/4x14	3/4	2.83	72	2.67	68	1-1/8	1.70	43
2188-16-16	1x11-1/2	1	3.35	85	3.18	81	1-3/8	1.97	50
2188-20-20	1-1/4x11-1/2	1-1/4	3.80	97	3.41	87	1-3/4	2.21	56
2188-24-24	1-1/2x11-1/2	1-1/2	4.20	107	3.61	92	2	2.46	62
2188-32-32	2x11-1/2	2	4.86	123	4.23	107	2-1/2	3.03	77

D

E

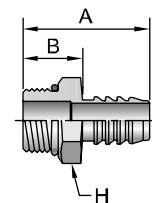

0588 Male SAE Straight Thread with O-Ring - Rigid

# Part Number	Thread inch	Hose I.D. inch	A		H inch	B	
			inch	mm		inch	mm
0588-12-12	1-1/16x12	3/4	2.13	54	1-1/4	1	25
0588-16-16	1-5/16x12	1	2.38	60	1-1/2	1	25
0588-20-20	1-5/8x12	1-1/4	2.59	66	1-7/8	1	25

See page B-202 for 81 Series crimp shells and clamps for 88 Series fittings.
See Equipment Section for assembly and crimping instructions.
See Accessories Section for O-Rings and Flange Kits.

0688

Female JIC 37° - Swivel

# Part Number	Thread		Hose I.D. inch	A		W inch	B	
	inch	inch		inch	mm		inch	mm
0688-12-12	3/4	1-1/16x12	3/4	2.66	68	1-1/4	1.53	39
0688-16-12	1	1-5/16x12	3/4	1.86	47	1-1/2	1.38	35
0688-16-16	1	1-5/16x12	1	2.72	69	1-1/2	1.34	34
0688-20-20	1-1/4	1-5/8x12	1-1/4	3.34	85	2	1.75	44
0688-24-24	1-1/2	1-7/8x12	1-1/2	3.67	93	2-1/4	1.93	49
0688-32-32	2	2-1/2x12	2	4.14	105	2-7/8	2.31	59

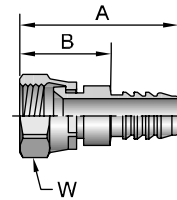

3788

Female JIC 37° - Swivel

# Part Number	Thread		Hose I.D. inch	A		E		W inch	B	
	inch	inch		inch	mm	inch	mm		inch	mm
3788-12-12	3/4	1-1/16x12	3/4	3.07	78	0.79	20	1-1/4	1.94	49
3788-16-16	1	1-5/16x12	1	3.51	89	0.90	23	1-1/2	2.13	54
3788-20-20	1-1/4	1-5/8x12	1-1/4	3.97	101	1.19	30	2	2.38	60

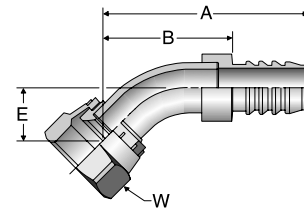

3988

Female JIC 37° - Swivel

# Part Number	Thread		Hose I.D. inch	A		E		W inch	B	
	inch	inch		inch	mm	inch	mm		inch	mm
3988-12-12	3/4	1-1/16x12	3/4	2.98	76	1.82	46	1-1/4	1.85	47
3988-16-16	1	1-5/16x12	1	3.48	88	2.14	54	1-1/2	2.10	53
3988-20-20	1-1/4	1-5/8x12	1-1/4	3.81	97	2.59	66	2	2.22	56
3988-24-24	1-1/2	1-7/8x12	1-1/2	4.21	107	2.81	71	2-1/4	2.47	63

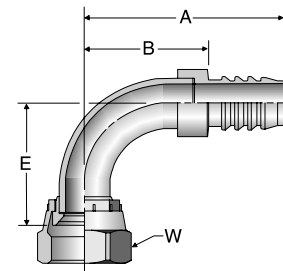

1588

SAE Code 61 Flange Head

ISO 12151-3 - S - L

# Part Number	Flange inch	Hose I.D. inch	A		F inch	B	
			inch	mm		inch	mm
1588-16-16	1	1	2.57	65	1-3/4	1.19	30
1588-20-20	1-1/4	1-1/4	3.37	86	2	1.78	4
1588-24-24	1-1/2	1-1/2	3.78	96	2-3/8	2.04	52
1588-32-32	2	2	4.32	110	2-13/16	2.49	63
1588-40-40	2-1/2	2-1/2	4.56	116	3-1/8	2.73	69
1588-48-40	3	2-1/2	4.62	117	4	2.79	71

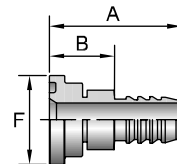

See page B-202 for 81 Series crimp shells and clamps for 88 Series fittings.
See Equipment Section for assembly and crimping instructions.
See Accessories Section for O-Rings and Flange Kits.

A

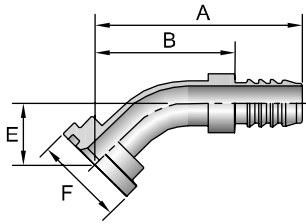

1788

SAE Code 61 Flange Head - 45° Elbow

ISO 12151-3 - E45S - L (1 Piece: ISO 12151-3 - E45M - L)

# Part Number	Flange inch	Hose I.D. inch	A		E		F inch	B	
			inch	mm	inch	mm		inch	mm
1788-16-16	1	1	3.55	90	1.06	27	1-3/4	2.17	55
1788-20-20	1-1/4	1-1/4	3.90	99	1.13	29	2	2.31	59
1788-24-24	1-1/2	1-1/2	4.15	105	1.11	28	2-3/8	2.41	61
1788-32-32	2	2	4.58	116	1.25	32	2-13/16	2.75	70
1788-40-40	2-1/2	2-1/2	5.17	131	1.41	36	3-1/8	3.34	85
1788-48-40	3	2-1/2	5.21	132	1.45	37	4	3.38	86

B

1988

SAE Code 61 Flange Head - 90° Elbow

ISO 12151-3 - E90S - L (1 Piece: ISO 12151-3 - E90M - L)

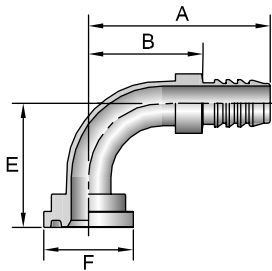

# Part Number	Flange inch	Hose I.D. inch	A		E		F inch	B	
			inch	mm	inch	mm		inch	mm
1988-16-16	1	1	3.35	85	2.37	60	1-3/4	1.97	50
1988-20-20	1-1/4	1-1/4	3.80	97	2.50	64	2	2.21	56
1988-24-24	1-1/2	1-1/2	4.20	107	2.74	70	2-3/8	2.46	62
1988-32-32	2	2	4.86	123	3.19	81	2-13/16	3.03	77
1988-40-40	2-1/2	2-1/2	5.52	140	3.75	95	3-1/8	3.69	94
1988-48-40	3	2-1/2	5.52	140	3.81	97	4	3.69	94

C

D

JS88

Female Seal-Lok® - Swivel - Long

ISO - 12151-1 - SWSB

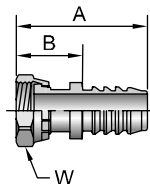

# Part Number	Thread		Hose I.D. inch	A		W inch	B	
	inch	1-11/16x12		inch	mm		inch	mm
JS88-20-20	1-1/4	1-11/16x12	1-1/4	3.21	82	1-7/8	1.15	29
JS88-24-24	1-1/2	2x12	1-1/2	3.47	88	2-1/4	1.73	44

E

See page B-202 for 81 Series crimp shells and clamps for 88 Series fittings.
See Equipment Section for assembly and crimping instructions.
See Accessories Section for O-Rings and Flange Kits.

JC88

Female Seal-Lok - Swivel - Short ISO 12151- 1 - SWSA

# Part Number	Thread		Hose I.D. inch	A		C inch	H inch	W inch	B	
	inch	1-3/16x12		inch	mm				inch	mm
JC88-12-12	3/4	1-3/16x12	3/4	2.80	71	0.57	1-1/8	1-3/8	1.70	43
JC88-16-12	1	1-7/16x12	3/4	2.82	72	0.58	1-3/8	1-5/8	1.69	43
JC88-16-16	1	1-7/16x12	1	3.07	78	0.59	1-3/8	1-5/8	1.69	43
JC88-20-16	1-1/4	1-11/16x12	1	3.08	78	0.59	1-7/8	1-5/8	1.70	43
JC88-20-20	1-1/4	1-11/16x12	1-1/4	3.29	84	0.59	1-7/8	1-7/8	1.70	43

When measuring overall length to the end of the nut, B+C dimensions must be used to calculate cut-off allowance.

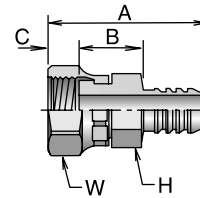

J788

Female Seal-Lok - Swivel - 45° Elbow

# Part Number	Thread		Hose I.D. inch	A		E		W inch	B	
	inch	1-3/16x12		inch	mm	inch	mm		inch	mm
J788-12-12	3/4	1-3/16x12	3/4	2.92	74	0.79	20	1-3/8	1.79	45
J788-16-16	1	1-7/16x12	1	3.79	96	0.94	24	1-5/8	2.41	61
J788-20-20	1-1/4	1-11/16x12	1-1/4	3.71	94	0.94	24	1-7/8	2.12	54

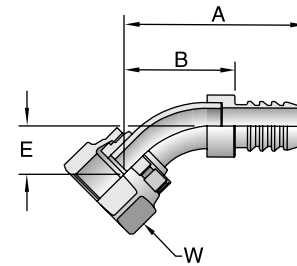

J988

Female Seal-Lok - Swivel - 90° Elbow - Short Drop

# Part Number	Thread		Hose I.D. inch	A		E		W inch	B	
	inch	1-3/16x12		inch	mm	inch	mm		inch	mm
J988-12-12	3/4	1-3/16x12	3/4	2.85	72	1.83	46	1-3/8	1.72	44
J988-16-16	1	1-7/16x12	1	3.74	95	2.19	56	1-5/8	2.36	60
J988-16-16C	1	1-7/16x12	1	3.75	95	2.22	56	1-5/8	2.37	60
J988-20-20	1-1/4	1-11/16x12	1-1/4	4.26	108	2.51	64	1-7/8	2.67	68
J988-24-24	1-1/2	2x12	1-1/2	5.27	134	2.68	68	2-1/4	3.53	90

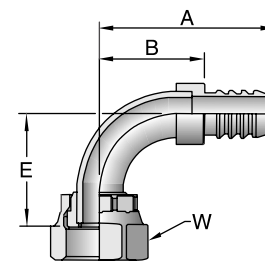

8888
 Union (Hose Splicer)

# Part Number	Hose I.D. inch	A	
		inch	mm
8888-12-12	3/4	2.70	67
8888-16-16	1	3.21	82
8888-20-20	1-1/4	3.61	92
8888-24-24	1-1/2	3.92	100
8888-32-32	2	4.04	103

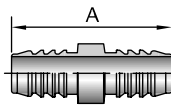

88HC
 Hose Clamp (Worm Gear)

# Part Number	Hose I.D. inch
88HC-12	3/4
88HC-16	1
88HC-20	1-1/4
88HC-24	1-1/2
88HC-32	2



10081
 Crimp Shell

# Part Number	Hose I.D. inch
10081-12	3/4
10081-16	1
10081-20	1-1/4
10081-24	1-1/2
10081-32	2



81 Series consists of a 10081 crimp shell and is completed by adding any 88 Series Fittings. See Equipment Section for complete 81 Series Assembly and Crimping instructions.

88HC-H
 Hose Clamp
 (High Torque Worm Gear)

# Part Number	Hose I.D. inch
88HC-16C	3/4
88HC-16H	1
88HC-20H	1-1/4
88HC-24H	1-1/2
88HC-32H	2

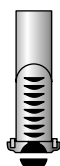

88DB
 Heavy Hose Clamp
 (Double Bolt)

# Part Number	Hose I.D. inch
88DB-12	3/4
88DB-16	1
88DB-20	1-1/4
88DB-24	1-1/2
88DB-32	2

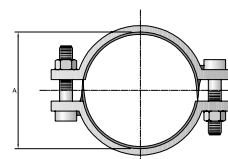

88 Series

Hose Assembly Instructions

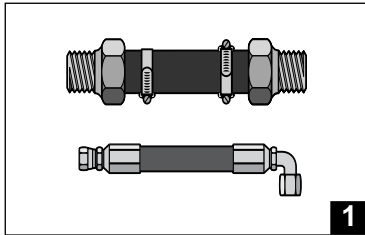

1

1. Identify Over All Length (OAL) of hose assembly and the Cut Off Allowance (COA) length of fitting(s) by use of the fitting data table. Properly measure and mark hose. Cut hose cleanly and squarely to length. Trim any exposed wire reinforcement to prevent injury in service.

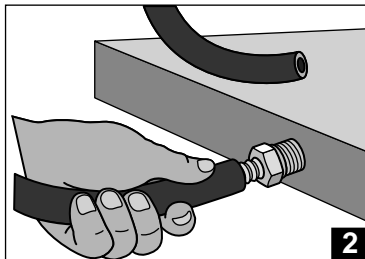

2

2. Slide clamp(s) onto hose and lubricate hose. Push hose onto fitting until hose bottoms against stop ring or hex.

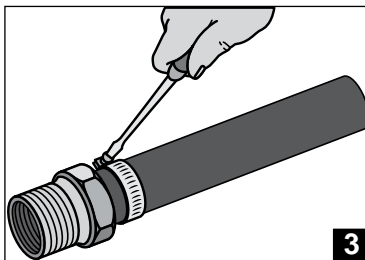

3

3. Position hose clamp(s) as shown and secure with a screwdriver or wrench. Maintain "A" dimensions as shown below for proper clamp positioning of both HC clamps and HC-H clamps.

3A. Evenly attach double bolt clamps for maximum grip.

Hose I.D.	A	
	inch	mm
-12	1/4	6.35
-16	3/8	9.53
-20	3/8	9.53
-24	1/2	12.70
-32	1/2	12.70

Note: For permanent installation of 88 Series Fittings, an 81 Series Crimp Shell must be added. See Equipment Section for assembly and crimping instructions.

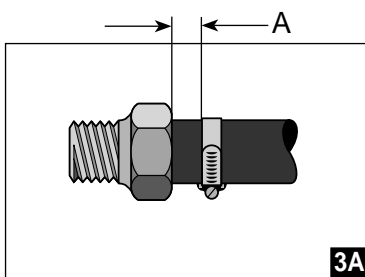

3A

IF YOU HAVE QUESTIONS CONCERNING THE PRODUCTS OR APPLICATION OF THE PRODUCTS CONTAINED IN THIS CATALOG, PLEASE CALL:

PARKER HOSE PRODUCTS DIVISION
TECHNICAL SERVICES DEPARTMENT
PHONE: 440-943-5700
FAX: 440-943-3129
<http://www.parkerhose.com>





A

B

C

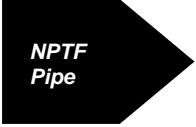
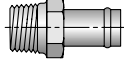
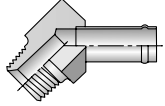
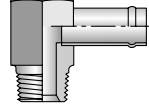
D

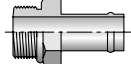
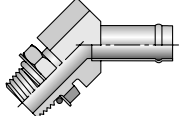
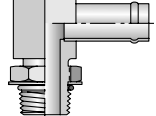
E

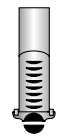
 <p>NPTF Pipe</p>	<p>01TB B-206</p>  <p><i>Male - Rigid</i></p>	<p>31TB B-206</p>  <p><i>Male - Rigid 45° Elbow</i></p>	<p>21TB B-206</p>  <p><i>Male - Rigid 90° Elbow</i></p>	 <p>SAE Straight Thread</p>	<p>05TB B-207</p>  <p><i>Male - Rigid</i></p>
<p>35TB B-207</p>  <p><i>Male - Rigid 45° Elbow</i></p>	<p>25TB B-207</p>  <p><i>Male - Rigid 90° Elbow</i></p>	 <p>Clamp</p>	<p>Clamp B-202</p>  <p><i>Wormgear</i></p>		

A

B

C

D

E

01TB Male NPTF Pipe - Rigid

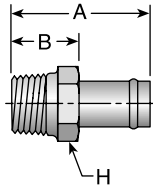

# Part Number	Thread inch	Hose I.D. inch	A		H		B	
			inch	mm	inch	inch	mm	
01TB-4-6	1/4x18	3/8	2.09	53	5/8	0.96	24	
01TB-6-8	3/8x18	1/2	2.12	54	3/4	0.96	24	
01TB-8-10	1/2x14	5/8	2.31	59	7/8	1.15	29	
01TB-8-12	1/2x14	3/4	2.31	59	1	1.15	29	
01TB-12-12	3/4x14	3/4	2.31	54	1-1/8	1.15	24	
01TB-16-16	1x11-1/2	1	2.69	68	1-3/8	1.53	39	
01TB-20-20	1-1/4x11-1/2	1-1/4	2.84	72	1-3/4	1.34	34	
01TB-24-24	1-1/2x11-1/2	1-1/2	3.25	83	2	1.50	38	
01TB-32-32	2x11-1/2	2	3.53	90	2-5/8	1.78	45	

31TB Male NPTF Pipe - Rigid - 45° Elbow

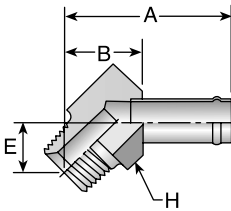

# Part Number	Thread inch	Hose I.D. inch	A		E		H		B	
			inch	mm	inch	mm	inch	inch	mm	
31TB-6-8	3/8x18	1/2	2.54	65	0.69	18	7/8	1.04	26	
31TB-8-10	1/2x14	5/8	2.68	68	0.82	21	1	1.18	30	
31TB-8-12	1/2x14	3/4	2.78	71	0.82	21	1-1/4	1.28	33	
31TB-12-12	3/4x14	3/4	2.82	72	0.86	22	1-1/4	1.32	34	
31TB-12-16	3/4x14	1	3.01	76	0.86	22	1-1/2	1.38	35	
31TB-16-16	1x11-1/2	1	3.19	81	1.04	26	1-1/2	1.56	40	
31TB-20-20	1-1/4x11-1/2	1-1/4	3.26	83	0.99	25	1-7/8	1.59	40	

21TB Male NPTF Pipe - Rigid - 90° Elbow

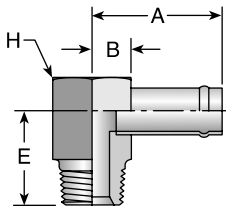

# Part Number	Thread inch	Hose I.D. inch	A		E		H		B	
			inch	mm	inch	mm	inch	inch	mm	
21TB-6-8	3/8x18	1/2	1.94	49	1.22	31	7/8	0.44	11	
21TB-8-10	1/2x14	5/8	2.03	52	1.47	37	1-1/16	0.53	13	
21TB-8-12	1/2x14	3/4	2.16	55	1.59	40	1-5/16	0.66	17	
21TB-12-12	3/4x14	3/4	2.16	55	1.59	40	1-5/16	0.66	17	
21TB-12-16	3/4x14	1	2.44	62	1.59	40	1-5/8	0.81	21	
21TB-16-14	1x11-1/2	7/8	2.31	59	1.97	50	1-5/8	0.81	21	
21TB-16-16	1x11-1/2	1	2.44	62	1.97	50	1-5/8	0.81	21	

05TB

Male SAE Straight Thread with O-Ring - Rigid

# Part Number	Thread		Hose I.D.		A		H		B	
	inch	mm	inch	mm	inch	mm	inch	mm	inch	mm
05TB-6-6	9/16x18		3/8	1.94	49	11/16	0.69	18		
05TB-8-8	3/4x16		1/2	2.00	51	7/8	0.75	19		
05TB-8-10	3/4x16		5/8	2.00	51	7/8	0.75	19		
05TB-10-10	7/8x14		5/8	2.06	52	1	0.81	21		
05TB-12-12	1-1/16x12		3/4	2.25	57	1-1/4	1.00	25		
05TB-16-16	1-5/16x12		1	2.38	60	1-1/2	1.00	25		
05TB-20-20	1-5/8x12		1-1/4	2.50	64	1-7/8	1.00	25		

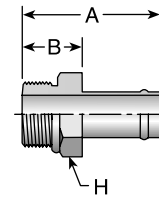

35TB

Male SAE Straight Thread with O-Ring - Rigid - 45° Elbow

# Part Number	Thread		Hose I.D.		A		E		H		W		B	
	inch	mm	inch	mm	inch	mm	inch	mm	inch	mm	inch	mm	inch	mm
35TB-8-8	1/2	3/4x16	1/2	2.79	71	0.93	24	7/8	7/8	1.29	33			
35TB-10-10	5/8	7/8x14	5/8	2.80	71	0.93	24	1	1	1.28	33			
35TB-12-12	3/4	1-1/16x12	3/4	3.18	81	1.22	31	1-1/4	1-1/4	1.68	43			
35TB-16-16	1	1-5/16x12	1	3.45	88	1.30	33	1-1/2	1-1/2	1.82	46			
35TB-20-16	1-1/4	1-5/8x12	1	3.57	91	1.34	34	1-7/8	1-7/8	1.94	49			

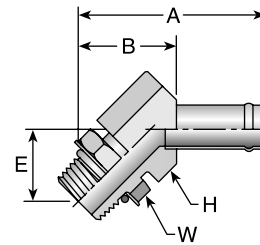

25TB

Male SAE Straight Thread with O-Ring - Rigid - 90° Elbow

# Part Number	Thread		Hose I.D.		A		E		H		W		B	
	inch	mm	inch	mm	inch	mm	inch	mm	inch	mm	inch	mm	inch	mm
25TB-8-8	1/2	3/4x16	1/2	1.94	49	1.44	37	7/8	7/8	0.44	11			
25TB-10-10	5/8	7/8x14	5/8	2.03	52	1.69	43	1-1/16	1	0.53	13			
25TB-10-12	5/8	7/8x14	3/4	2.16	55	1.69	43	1-5/16	1	0.66	17			
25TB-12-12	3/4	1-1/16x12	3/4	2.16	55	1.92	49	1-5/16	1-1/4	0.66	17			
25TB-16-12	1	1-5/16x12	3/4	2.31	59	2.03	52	1-5/8	1-1/2	0.81	21			
25TB-16-16	1	1-5/16x12	1	2.44	62	2.03	52	1-5/8	1-1/2	0.81	21			
25TB-20-16	1-1/4	1-5/8x12	1	2.57	65	2.34	59	1-7/8	1-7/8	0.94	24			
25TB-20-20	1-1/4	1-5/8x12	1-1/4	2.61	66	2.34	59	1-7/8	1-7/8	0.94	24			

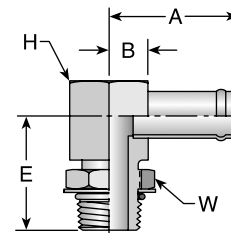

A

B

C

D

E

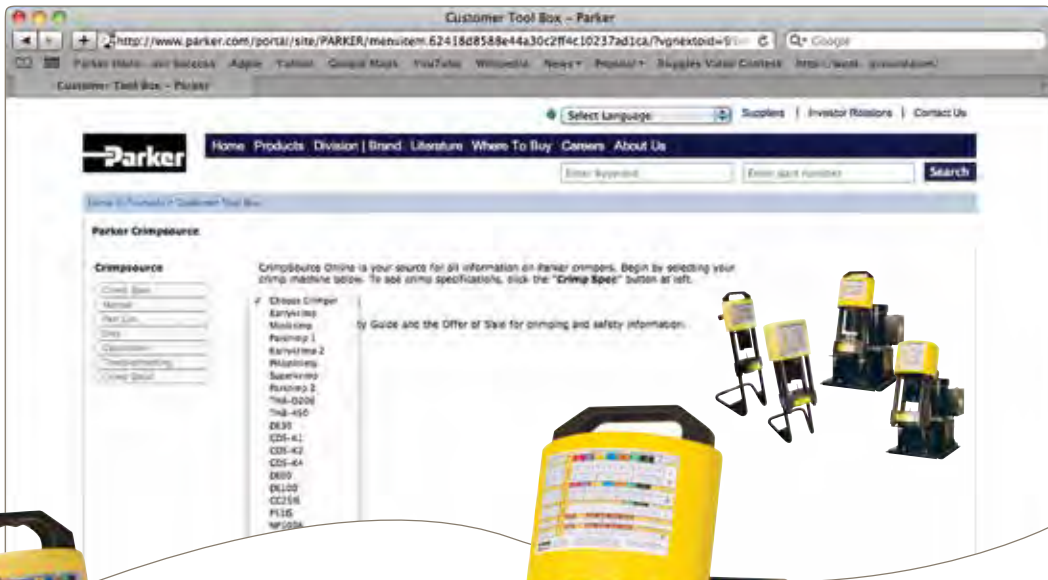

Visit CrimpSource at www.parker.com/crimpsource, your online resource for hose crimp specifications.

Equipment



ENGINEERING YOUR SUCCESS.

A
B
C
D
E

<p>Karrykrimp C-8</p> 	<p>Karrykrimp Bench Mount C-8</p> 	<p>Karrykrimp 2 C-10</p> 
<p>Karrykrimp 2 Bench Mount C-10</p> 	<p>Parkrimp 2 C-12</p> 	<p>Minikrimp C-14</p> 
<p>Portable Pumps C-16</p> 	<p>Crimpsource C-17</p> 	<p>Parkrimp and Twin-Tough Instructions C-18-21</p> 
<p>Conversion Kits C-22</p> 	<p>332T-115V C-23</p>  <p>Hose Cut-Off Machine</p>	<p>239 and 339 C-23</p>  <p>Hose Cut-Off Machine</p>



<p>631075 C-23</p>  <p><i>Karrykut - Hose Cut-Off Machine</i></p>	<p>Hose Cut-Off Machine C-23</p>  <p><i>TH3-51</i></p>	<p>TH6-10-HL-9-2 C-24</p>  <p><i>Ultra Clean Hose Cleaning Kit</i></p>
<p>TH6-10-EL-7 C-24</p>  <p><i>Economy Hose Cleaning Kit</i></p>	<p>871522 C-26</p>  <p><i>Handycut - Hose Cut-Off Machine</i></p>	<p>881540 C-26</p>  <p><i>Push-Lok Cut-Off & Assembly Tool</i></p>
<p>TH9-1 C-26</p>  <p><i>Hose Insertion Depth Blocks</i></p>	<p>TH11-1 C-26</p>  <p><i>Hose Cut-Off Tool</i></p>	<p>432-115V C-27</p>  <p><i>Hozemblem</i></p>
<p>80C-0DR and 83C-0DR C-27</p>  <p><i>Die Storage Racks</i></p>	<p>80C-SDR C-27</p>  <p><i>Swivel Die Rack</i></p>	<p>TH2-7 C-27</p>  <p><i>Fittings Push-On Stand</i></p>
<p>652200 C-28</p>  <p><i>Mandrel Tool Kit - 22 Series</i></p>	<p>2727 and 2726 C-28</p>  <p><i>Mandrel Tool Kit - 23 Series</i></p>	<p>TH2-7M25-6, TH2-7M25-8 C-28</p>  <p><i>Mandrels - 25 Series</i></p>
<p>652201 C-28</p>  <p><i>Assembly Tools - 22 Series</i></p>	<p>601069 C-29</p>  <p><i>Hose Perforator</i></p>	<p>Hose Oil C-29</p>  <p><i>Hose Oil</i></p>

A

B

C

D

E



A

<p>Lubricant</p> <p>C-29</p>  <p><i>Accrolube - High Efficiency</i></p>	<p>Small Crimper Hood</p> <p>C-29</p> 	<p>Large Crimper Hood</p> <p>C-29</p> 
--	---	---

B

C

D

E

A

B

C

D

E

Hose Assemblies Are Easy With the Parkrimp System.

Since its introduction in 1980, the Parkrimp family of crimping machines has led the industry in ease of use and rugged durability.

When it comes to hose assemblies, no one puts it all together like Parker. From high-volume productivity to portable on-site assembly, we offer a variety of crimping machines, No-Skive hoses, and No-Skive fittings to meet your needs.

With Parkrimp equipment, anyone can make factory-quality hose assemblies quickly, easily, and cost effectively. Parkrimp machines are simple to operate and they're built to provide years of dependable service. Seven Parkrimp models – an entire family of crimpers – are available to meet your bench-mounted or portable needs, crimping straight or bent-stem fittings from 1/4" to 2" in diameter. Just use our No-Skive hoses and fittings to create leak-free hose assemblies whenever and wherever you need them.

The complete system from one source: No-Skive hose, No-Skive fittings, and crimping machines with worldwide availability and service.



With Parkrimp, you benefit from a full length crimp.

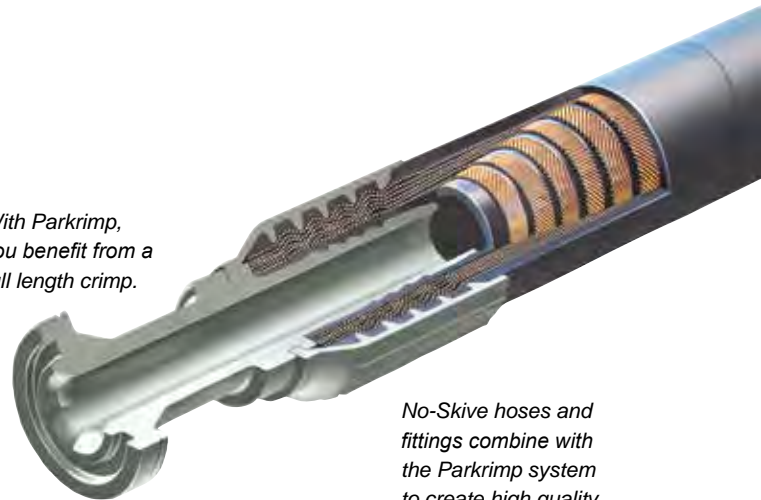

Our low profile design makes routing hose assemblies easy.

No-Skive hoses and fittings combine with the Parkrimp system to create high quality, reliable hydraulic hose assemblies every time.

Eight segment crimp dies provide a smooth, even, 360-degree crimp.

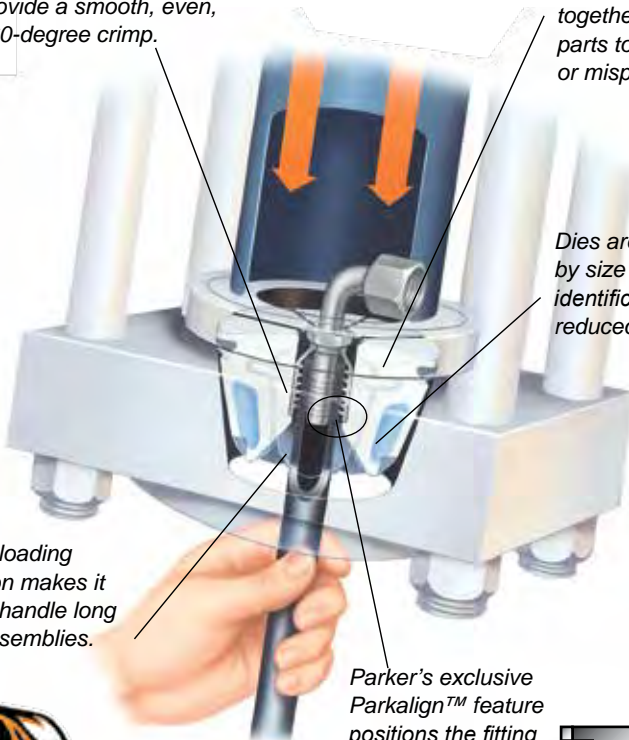

Our linked crimp dies keep die segments together. No loose parts to mismatch or misplace.

Dies are color-coded by size for easy identification and reduced set-up time.

Bottom-loading operation makes it easy to handle long hose assemblies.

Parker's exclusive Parkalign™ feature positions the fitting in the dies perfectly every time.

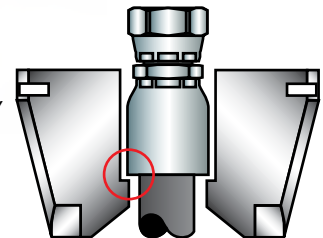

Be sure to check www.parker.com/crimpsource for the most up to date information and crimp specifications.

Selecting the right die.

Once the proper Parker Hose and Fitting is selected that meets your application requirements, you will need to select the proper die to assemble them together.

Based on the hose size and approved fitting, select the proper color coded die, as called out in the chart below.

Example:

Hose	451TC-4
Fitting	43 Series
Die Body Color	Silver
Die Cavity Color (-4)	RED

Based on the Parkrimp machine being used to assemble the hose and fitting, individual die part numbers and tooling selection for your assembly can be found in Section C of this catalog.

For general hose assembly instructions for all Parkrimp machines, please turn to pages C-18 and C-19. (An instructional video is a standard part of each Parkrimp machine shipped from the manufacturer.)

Parker Hose Products Division also offers a full line of crimping accessories, including conversion kits, cabinets, cut-off saws, push-on tables, die racks, and mandrel tool kits.



Hose Dash Size	Die Cavity Color Code	43 Series Die Body Color	70, 71 & 77 Series Die Body Color	73, 78, S6 & 79 Series Die Body Color	76 Series Die Body Color	25 Series Die Body Color	26 Series Die Body Color	81 Series Die Body Color
		Silver	Black	Olive Drab	Silver	Silver	Silver	Silver
-4	RED		N/A	N/A	N/A	N/A		N/A
-5	PURPLE		N/A	N/A	N/A	N/A		N/A
-6	YELLOW			N/A	N/A			N/A
-8	BLUE			N/A	N/A			N/A
-10	ORANGE			N/A	N/A	N/A		N/A
-12	GREEN					N/A		
-16	BLACK					N/A		
-20	WHITE				N/A	N/A		
-24	RED				N/A	N/A		
-32	GREEN				N/A	N/A		

Hose Dash Size	Die Cavity Color Code	HY Series Die Body Color
		Silver
-4	BROWN	
-5	BROWN	
-6	BROWN	
-8	BROWN	
-10	BROWN	
-12	BROWN	
-16	BROWN	



Reference pages C-8 through C-17 for specific tool information regarding hose, fitting, and crimper combinations.



Karrykrimp



The Karrykrimp is now available in a modular design with all the familiar Parkrimp System advantages.

The same unit now offers portability and bench mountability.

Capability

- Up to 1-1/4" ID 2 wire braided hose
- Up to 5/8" ID 4 wire spiral hose
- Only steel fittings

Features

- Portable, compact rugged design
- Numerous portable power unit options available
- Pivoting pusher design for easy die change out
- Increased height enables longer bent tube fittings to be crimped
- For use with 25, 26, 43, 81, and HY Series fittings

Specifications

- Dimensions: 15" wide, 12" deep, 30" high
- Weight: 60 lbs (without power unit)
- Rating: 30 ton force @ 10,000 psi maximum
- Full Cycle Time: 30 seconds 82C-0EP power unit (1/2" 43 Series)
- Reference page C-16 for information on available power units

Standard Equipment

Part Number			Description	Individual Part Number
82C-CHD	82C-061L	82C-KKB		
●	●	●	Crimp Head	82C-CHD
		●	Bench Power Unit Assembly	85C-1PH
●	●	●	Silver die ring	82C-R01
●	●	●	Black die ring	82C-R02
	●		Hose Assembly	85C-00L
	●		Stand Assembly	85C-STD

Karrykrimp Bench Mount



Capability

- Up to 1-1/4" ID 2 wire braided hose
- Up to 5/8" ID 4 wire spiral hose
- Only steel fittings

Features

- Faster cycle times on bench mounted units
- Pivoting pusher design for easy die change out
- Compact bench mount design
- Increased height enables longer bent tube fittings to be crimped
- For use with 25, 26, 43, 81, and HY Series fittings

Specifications

- Dimensions: 17" wide, 23" deep, 27-1/2" high
- Weight: 146 lbs
- Rating: 30 ton force @ 10,000 psi maximum
- Full Cycle Time: 11 seconds (1/2" 43 Series)
- Hydraulic Fluid: AW32 oil
- This unit is designed to make about 400 crimps per day and is not designed to be a production crimper. Exceeding these suggested production amounts will significantly reduce the the expectancy of the crimper components.

- **Note:** Motor is dual voltage, 50/60hz suitable for 208-230/115v, 1ph, 60hz and 220-230/110v, 1ph, 50hz. Motor can be rewired by a qualified electrician to operate at alternate voltage.











Note:

- For crimp instructions, see pages C-18 and C-19.
- Hose assemblies must be inspected for cleanliness and free of all foreign particles.
- Parker Hannifin will not accept responsibility for the operation of, or provide warranty coverage for, a crimper that is operated by a power unit other than equipment supplied by Parker Hannifin for the express purpose of operating the crimper.



Parker Hannifin Corporation
Hose Products Division
30240 Lakeland Blvd.
Wickliffe, Ohio 44092

Karrykrimp/Karrykrimp Bench Mount Hose Die Selection Chart

Fitting Series	HOSE	-4 RED	-5 PUR	-6 YEL	-8 BLU	-10 ORG	-12 GRN	-16 BLK	-20 WHT	Die Ring
43 Series	Die Part Number	80C-A04	80C-A05	80C-A06	80C-A08	80C-A10	80C-A12	80C-A16	80C-A20	
	351TC/ST 431 422 436 424 451TC/ST 472TC / LT 426 471TC/ST 482TC/ST	0.645 0.665	0.710 0.730	0.825 0.845	0.945 0.965	1.060 1.080	1.245 1.265	1.590 1.610	1.970 1.990	 SILVER
	421WC 304 302/301 341 301LT 381 722TC / LT (-6, -8, -10 ONLY)	0.685 0.705	0.750 0.770	0.865 0.885	0.985 1.005	1.100 1.120	1.285 1.305	1.630 1.650	2.010 2.030	 BLACK
26 Series	Die Part Number	80C-E04	80C-E05	80C-E06	80C-E08	80C-E10	80C-E12	80C-E16		
	213 285 293	0.460 0.480	0.520 0.540	0.575 0.595	0.670 0.690	0.805 0.825	0.915 0.935	1.175 1.195		 SILVER
	201 225 206 244 221FR 266 SS25UL	0.500 0.520	0.560 0.580	0.615 0.635	0.710 0.730	0.845 0.865	0.955 0.975	1.215 1.235		 BLACK
81 Series	Die Part Number						80C-V12	80C-V16	80C-V20	
	811 811HT 881						1.155 1.175	1.450 1.470	1.740 1.760	 SILVER
HY Series	Die Part Number	80C-H585		80C-H735	80C-H840	80C-H970	80C-H1120			
	AX	0.575 0.595		0.725 0.745	0.830 0.850	0.960 0.980	1.110 1.130			 SILVER
	Die Part Number	80C-H605		80C-H775	80C-H885	80C-H1010	80C-H1170			
	BXX	0.635 0.655		0.805 0.825	0.915 0.935	1.040 1.060	1.200 1.220			 BLACK
	Die Part Number	80C-H595		80C-H735	80C-H860	80C-H1015	80C-H1170	80C-H1365		
611HT 801 836	0.575 0.595		0.720 0.740	0.860 0.880	0.995 1.015	1.140 1.160	1.350 1.370		 SILVER	
<p>Caution: Read the operations and technical manual before attempting to operate this machine. Do not operate this machine without guard in place. Keep hands clear of moving parts when operating machine.</p>						<p>Note: Do not use this machine to assemble 341-20, 451TC-20, 451ST-20, 472TC-20 or any size stainless steel fittings.</p>				
<p>For a new Decal, contact Parker at: 1-800-C-PARKER or print your own at www.parker.com/crimpsource. Decal Part Number: 82C-CRIMPDECAL</p>										
REV. A										

A

B

C

D

E



Karrykrimp 2

The Karrykrimp 2 is now available in a modular design with all the familiar Parkrimp System advantages.

The same unit now offers portability and bench mountability.



Capability

- Up to 1-1/4" ID 2 wire braided hose
- Up to 1-1/4" ID 4 wire spiral hose
- Up to 1" ID 6 wire spiral hose

Features

- Portable, compact rugged design
- Numerous portable power unit options available
- Pivoting pusher design for easy die change out
- For use with 25,26, 43, 70, 71, 73, 77, 78, 81, and HY Series fittings

Specifications

- Dimensions: 14" wide, 14" deep, 31-1/2" high
- Weight: 120 lbs (without power unit)
- Rating: 60 ton force @ 10,000 psi maximum
- Full Cycle Time: 20 seconds with 85C-0EP power unit (1/2" 43 series)
- Reference page C-16 for information on available power units

Standard Equipment

Part Number			Description	Individual Part Number
85C-CHD	85C-061L	85C-KKB		
●	●	●	Crimp Head	85C-CHD
		●	Bench Power Unit Assembly	85C-1PH
●	●	●	Silver die ring	85C-R01
●	●	●	Black die ring	85C-R02
	●		Hose Assembly	85C-00L
	●		Stand Assembly	85C-STD

Optional Tooling

- Die Kit (85C-KDA) Includes 43 Series dies in sizes 1/4", 3/8", 1/2", 3/4", 1" and 1-1/4" and 70/71 Series dies in sizes 3/8", 1/2", 3/4", 1", 1-1/4" **ONLY**.

Note:

- For crimp instructions, see pages C-18 and C-19.
- Hose assemblies must be inspected for cleanliness and free of all foreign particles.
- Parker Hannifin will not accept responsibility for the operation of, or provide warranty coverage for, a crimper that is operated by a power unit other than equipment supplied by Parker Hannifin for the express purpose of operating the crimper.

Karrykrimp 2 Bench Mount



Capability

- Up to 1-1/4" ID 2 wire braided hose
- Up to 1-1/4" ID 4 wire spiral hose
- Up to 1" ID 6 wire spiral hose

Features

- Faster cycle times on bench mounted units
- Pivoting pusher design for easy die change out
- Compact bench mount design
- For use with 25, 26, 43, 70, 71, 73, 77, 78, 81, and HY Series fittings

Specifications

- Dimensions: 17" wide, 23" deep, 28" high
- Weight: 208 lbs
- Rating: 60 ton force @ 10,000 psi maximum
- Full Cycle Time: 17 seconds (1/2" 43 series)
- Hydraulic Fluid: AW32 oil
- This unit is designed to make about 400 crimps per day and is not designed to be a production crimper. Exceeding these suggested production amounts will significantly reduce the expectancy of the crimper components.

- **Note:** Motor is dual voltage, 50/60hz suitable for 208-230/115v, 1ph, 60hz and 220-230/110v, 1ph, 50hz. Motor can be rewired by a qualified electrician to operate at alternate voltage.





Parker Hannifin Corporation
Hose Products Division
30240 Lakeland Blvd.
Wickliffe, Ohio 44092

Karrykrimp 2/Karrykrimp 2 Bench Mount Hose Die Selection Chart

Fitting Series	HOSE	-4 RED	-5 PUR	-6 YEL	-8 BLU	-10 ORG	-12 GRN	-16 BLK	-20 WHT	Die Ring			
43 Series	Die Part Number	80C-A04	80C-A05	80C-A06	80C-A08	80C-A10	80C-A12	80C-A16	80C-A20				
	351TC/ST 422 424 426	431 436 451TC/ST 471TC/ST	472LT 472TC 482TC/ST 722LT	0.645 0.665	0.710 0.730	0.825 0.845	0.945 0.965	1.060 1.080	1.245 1.265	1.590 1.610	1.970 1.990	SILVER	
	421WC 302 301LT	304 341 381 722ST / TC / LT	601 604 881	0.685 0.705	0.750 0.770	0.865 0.885	0.985 1.005	1.100 1.120	1.285 1.305	1.630 1.650	2.010 2.030	BLACK	
70 Series	Die Part Number				83C-D06	83C-D08	83C-D10						
	701 F42 (-8 Only)				0.990 1.010	1.140 1.160	1.260 1.280				BLACK		
71 Series	Die Part Number				83C-D06	83C-D08	83C-D10	83C-D12	83C-D16	83C-D20			
	711 721 721TC	721ST 722LT 772TC	772ST 774		0.950 0.970	1.100 1.120	1.220 1.240	1.355 1.375	1.695 1.715	2.025 2.045	SILVER		
73 Series	Die Part Number							80C-L12	80C-L16				
	731							1.420 1.440	1.730 1.750			SILVER	
77 Series	Die Part Number					80C-CS08	80C-CS10	80C-CS12					
	787TC 797TC					0.930 0.950	1.057 1.077	1.245 1.265				BLACK	
78 Series	Die Part Number							80C-L12	80C-L16				
	781 782TC 782ST							1.420 1.440	1.730 1.750			SILVER	
25 Series	Die Part Number				80C-Y06	80C-Y08							
	271				0.680 0.700	0.825 0.845					SILVER		
26 Series	Die Part Number	80C-E04	80C-E05	80C-E06	80C-E08	80C-E10	80C-E12	80C-E16					
	213 285 293	0.460 0.480	0.520 0.540	0.575 0.595	0.670 0.690	0.805 0.825	0.915 0.935	1.175 1.195			SILVER		
	201 206 221FR	225 244 266	SS25UL	0.500 0.520	0.560 0.580	0.615 0.635	0.710 0.730	0.845 0.865	0.955 0.975	1.215 1.235	BLACK		
81 Series	Die Part Number							80C-V12	80C-V16	80C-V20			
	811 811HT 881							1.155 1.175	1.450 1.470	1.740 1.760	SILVER		
HY Series	Die Part Number	80C-H585			80C-H735	80C-H840	80C-H970	80C-H1120	80C-H1365				
	AX	0.575 0.595			0.725 0.745	0.830 0.850	0.960 0.980	1.110 1.130	1.355 1.375			SILVER	
	Die Part Number	80C-H605			80C-H775	80C-H885	80C-H1010	80C-H1170	80C-H1465	80C-H1880			
	BXX	0.635 0.655			0.805 0.825	0.915 0.935	1.040 1.060	1.200 1.220	1.495 1.515	1.910 1.930			BLACK
	Die Part Number	80C-H595			80C-H735	80C-H860	80C-H1015	80C-H1170	80C-H1365				
611HT 801 836	0.575 0.595			0.720 0.740	0.860 0.880	0.995 1.015	1.140 1.160	1.350 1.370			SILVER		

Caution: Read the operations and technical manual before attempting to operate this machine. Do not operate this machine without guard in place. Keep hands clear of moving parts when operating machine.

Note: Stainless steel crimp diameters are 0.010" greater than table listings with the exception of HY series which are 0.005" greater than table listings.

For a new Decal, contact Parker at: 1-800-C-PARKER or print your own at www.parker.com/crimpsource.
Decal Part Number: 85C-CRIMPDECAL

REV. A

A

B

C

D

E



Parkrimp 2



A

B

C

D

E

Capability

- Up to 2" ID 2 wire braided hose
- Up to 2" ID 4/6 wire spiral hose

Features

- Easy to use vertical design
- Crimps full range of Parker hoses from 1/4" through 2" I.D.
- Crimps both steel and stainless steel fittings
- For use with 25, 26, 43, 70, 71, 73, 76, 77, 78, 79, 81, S6 and HY Series fittings

Specifications

- Dimensions: 31" wide, 24" deep, 77" high
- Weight: 842 lbs (Head is 558 lbs and base is 284 lbs)
- Rating: 125 ton force @ 5,000 psi maximum
- Full Cycle Time: 30 seconds without adapter bowl
20 seconds with adapter bowl
- Hydraulic oil: Enerpac oil

Standard Equipment

Part Number				Description	Individual Part Number
83C-001	83C-081	83C-002	83C-082		
●	●	●	●	Parkrimp 2 crimper head assembly	83C-080
●	●			Parkrimp 2 stand assembly with 230/460 volt, 3 phase, 50/60 Hz power unit (wired for 230 volt)	83C-S40
		●	●	Parkrimp 2 stand assembly with 230 volt, 1 phase, 50/60 Hz power unit	83C-S20
●	●	●	●	Adapter bowl	83C-OCB
●	●	●	●	Spacer ring	83C-R02
●	●	●	●	Spacer Plate	83C-R02H
●		●		Die Kit Includes 43 Series dies in sizes 1/4", 3/8", 1/2", 3/4", 1", 1-1/4" dies and 70/71 Series dies in sizes 3/8", 1/2", 3/4", 1", 1-1/4", 1-1/2", 2" ONLY	83C-KDA

Note:

- For crimp instructions, see pages C-18 and C-19.
- Hose assemblies must be inspected for cleanliness and free of all foreign particles.
- Parker Hannifin will not accept responsibility for the operation of, or provide warranty coverage for, a crimper that is operated by a power unit other than equipment supplied by Parker Hannifin for the express purpose of operating the crimper.



Parker		Parker Hannifin Corporation Hose Products Division 30240 Lakeland Blvd. Wickliffe, Ohio 44092		Parkrimp 2 Hose Die Selection Chart									
Fitting Series	HOSE	-4 RED	-5 PUR	-6 YEL	-8 BLU	-10 ORG	-12 GRN	-16 BLK	-20 WHT	-24 RED	-32 GRN		
43 Series	Die Part Number	80C-A04	80C-A05	80C-A06	80C-A08	80C-A10	80C-A12	80C-A16	80C-A20	80C-A24	80C-A32		
	351TC 431 471ST 361ST 438 472TC 422 451TC 472LT 424 451ST 482TC 426 471TC 482ST	0.645 0.665	0.710 0.730	0.825 0.845	0.945 0.965	1.060 1.080	1.245 1.265	1.590 1.610	1.970 1.990	2.290 2.310	2.735 2.755		
	Tooling Required												
70 Series	Die Part Number	83C-D06		83C-E08	83C-D10								
	701 F42 (-8 Only)	0.990 1.010		1.140 1.160	1.260 1.280								
	Tooling Required												
71 Series	Die Part Number	83C-D06		83C-E08	83C-D10	83C-D12	83C-D16	83C-D20	83C-D24	83C-D32			
	711 721ST 772ST 721 721TC 774 721TC 772TC 722ST / TC / LT (-24 and -32 Only)	0.950 0.970		1.100 1.120	1.220 1.240	1.355 1.375	1.695 1.715	2.025 2.045	2.290 2.310	2.775 2.795			
	Tooling Required												
73 Series	Die Part Number	83C-L12				83C-L16	83C-L20	83C-L24	83C-L32				
	731	1.420 1.440				1.730 1.750	2.140 2.160	2.440 2.460	3.025 3.045				
	Tooling Required												
76 Series	Die Part Number	83C-U12				83C-U16							
	761	1.540 1.560				1.865 1.885							
	Tooling Required												
77 Series	Die Part Number	80C-CS08		80C-CS10	80C-CS12	83C-CS16	83C-CS20						
	787TC 797TC	0.930 0.950		1.057 1.077	1.245 1.265	1.541 1.561	1.970 1.990						
	Tooling Required												
78/S6 Series	Die Part Number	83C-L12				83C-L16	83C-L20	83C-L24	83C-L32				
	P35 781 782TC 782ST	1.420 1.440				1.730 1.750	2.140 2.160	2.440 2.460	3.025 3.045				
	Tooling Required												
79 Series	Die Part Number	83C-L12				83C-L16	83C-L20	83C-L24	83C-L32				
	791TC 792TC 792LT F42 792ST	1.420 1.440				1.730 1.750	2.140 2.160	2.440 2.460	3.025 3.045				
	Tooling Required												
25 Series	Die Part Number	80C-Y06		80C-Y08									
	271	0.680 0.700		0.825 0.845									
	Tooling Required												
26 Series	Die Part Number	80C-E04	80C-E05	80C-E06	80C-E08	80C-E10	80C-E12	80C-E16	80C-E20	80C-E24	80C-E32		
	213 285 293	0.460 0.480	0.520 0.540	0.575 0.595	0.670 0.690	0.805 0.825	0.915 0.935	1.175 1.195	1.420 1.440	1.670 1.690	2.160 2.180		
	Tooling Required												
81 Series	Die Part Number	80C-V12				80C-V16	80C-V20	83C-V24	83C-V32				
	811 811HT 881	1.155 1.175				1.450 1.470	1.740 1.760	2.010 2.030	2.430 2.450				
	Tooling Required												
HY Series	Die Part Number	80C-H585	80C-H735	80C-H840	80C-H970	80C-H1120	80C-H1365						
	AX	0.575 0.595	0.725 0.745	0.830 0.850	0.960 0.980	1.110 1.130	1.355 1.375						
	Tooling Required												
HY Series	Die Part Number	80C-H605	80C-H775	80C-H885	80C-H1010	80C-H1170	80C-H1465	80C-H1880					
	BXX	0.635 0.655	0.805 0.825	0.915 0.935	1.040 1.060	1.200 1.220	1.495 1.515	1.910 1.930					
	Tooling Required												
HY Series	Die Part Number	80C-H595	80C-H735	80C-H860	80C-H1015	80C-H1170	80C-H1365						
	611HT 801 836	0.575 0.595	0.720 0.740	0.860 0.880	0.995 1.015	1.140 1.160	1.350 1.370						
	Tooling Required												

Caution: Read the operations and technical manual before attempting to operate this machine. Do not operate this machine without guard in place. Keep hands clear of moving parts when operating machine.

Note: Stainless steel crimp diameters are 0.010" greater than table listings with the exception of HY series which are 0.005" greater than table listings. Do not use lubricant to assemble spiral hose and fittings.

83C-R12 Split Die ring used for all crimping operations
 80C-xxx/83C-xxx small dies and 83C-OCB adapter bowl used on sizes -4 thru -20
 83C-R02 Spacer Ring used with adapter bowl when called out above
 83C-xxx Large dies used on sizes -16 thru -20
 83C-R02H Spacer Plate used when called out above

For a new Decal, contact Parker at: 1-800-C-PARKER or print your own at www.parker.com/crimpsource.
Decal Part Number: 83C-CRIMPDECAL

REV. B

A

B

C

D

E



Minikrimp™

A



94C-002-PFD



94C-001-PFD

B

Capability

- Up to 1" ID 2 wire braided hose
- Only steel fittings

C

Features

- Light weight, portable, compact all-in-one unit
- Handpump or air over hydraulic design
- Removable pusher design for easy die change out
- Reference page C-16 for information on available power units
- For use with 25, 26, 43, 81, and HY Series fittings
- Do not crimp stainless steel fittings

D

Specifications

- Dimensions: 6" wide, 13" deep, 15" high
- Weight: 42 lbs (with hand pump)
- Rating: 30 ton force @ 10,000 psi maximum
- Full Cycle Time: 30 seconds

E

Important

The Minikrimp was developed by Parker Hannifin Parflex Division but is compatible with Parker Hannifin Hose Products Division products. Refer to Crimpsource™ on www.parker.com/crimpsource (the online resource for hose crimp specifications for the complete line of Parker crimping machines). Any engineering and crimper performance issues pertaining to the Minikrimp should be directed to the Parflex Division, Technical Services Department, at (330) 296-2871 or fax, at (330) 296-8433.

Standard Equipment

Part Number		Description	Individual Part Number
94C- 001-PFD	94C- 002 -PFD		
●	●	Base unit	94C-080-PFD
●		Hand pump	015301
	●	Air over hydraulic pump kit with tubing and adapters	025411
●	●	Silver die ring	82C-R01-PFD

Optional Tooling

- Side Vise Mount (015736)
- Upright Table Mount (015306)
- Upright Vise Mount (015307)
- Black Die Ring (82C-R02-PFD)
- Connection Hose with Quick Coupling (015309)
- Bent Tube for Hand Pump Only (015308)
- Bent Tube for Air Over Hydraulic Pump Only (025349)

Note:

- For crimp instructions, see pages C-18 and C-19.
- Hose assemblies must be inspected for cleanliness and free of all foreign particles.
- Parker Hannifin will not accept responsibility for the operation of, or provide warranty coverage for, a crimper that is operated by a power unit other than equipment supplied by Parker Hannifin for the express purpose of operating the crimper.



Parker Hannifin Corporation
Hose Products Division
30240 Lakeland Blvd.
Wickliffe, Ohio 44092

Minikrimp Hose Die Selection Chart

Fitting Series	HOSE	-4 RED	-5 PUR	-6 YEL	-8 BLU	-10 ORG	-12 GRN	-16 BLK	Die Ring
43 Series	Die Part Number	80C-A04	80C-A05	80C-A06	80C-A08	80C-A10	80C-A12	80C-A16	
	351TC/ST 431 472TC 422 436 472LT 424 451TC/ST 482TC/ST 426 471TC/ST	0.645	0.710	0.825	0.945	1.060	1.245	1.590	
		0.665	0.730	0.845	0.965	1.080	1.265	1.610	SILVER
	421WC 304 601 302/301 341 604 301LT 381 881 722ST / TC / LT (-6, -8, -10 ONLY)	0.685	0.750	0.865	0.985	1.100	1.285	1.630	
		0.705	0.770	0.885	1.005	1.120	1.305	1.650	BLACK
26 Series	Die Part Number	80C-E04	80C-E05	80C-E06	80C-E08	80C-E10	80C-E12	80C-E16	
	213 285 293	0.460	0.520	0.575	0.670	0.805	0.915	1.175	
		0.480	0.540	0.595	0.690	0.825	0.935	1.195	SILVER
	201 225 206 244 221FR 266	0.500	0.560	0.615	0.710	0.845	0.955	1.215	
		0.520	0.580	0.635	0.730	0.865	0.975	1.235	BLACK
81 Series	Die Part Number						80C-V12	80C-V16	
	811 811HT 881						1.155	1.450	
							1.175	1.470	SILVER
HY Series	Die Part Number	80C-H585		80C-H735	80C-H840	80C-H970	80C-H120		
	AX	0.575		0.725	0.830	0.960	1.110		
		0.595		0.745	0.850	0.980	1.130		SILVER
	Die Part Number	80C-H605		80C-H775	80C-H885	80C-H1010	80C-H1180		
	BXX	0.635		0.805	0.915	1.040	1.200		
		0.655		0.825	0.935	1.060	1.220		BLACK
	Die Part Number	80C-H595		80C-H735	80C-H860	80C-H1015	80C-H1170	80C-H1365	
611HT 801 836	0.575		0.720	0.860	0.995	1.140	1.350		
		0.595		0.740	0.880	1.015	1.160	1.370	SILVER
Caution: Read the operations and technical manual before attempting to operate this machine. Do not operate this machine without guard in place. Keep hands clear of moving parts when operating machine.						Note: Do not use this machine to assemble stainless steel fittings with any hose listed on this chart.			
For a new Decal, contact Parker at: 1-800-C-PARKER or print your own at www.parker.com/crimpsource . Decal Part Number: 800C-CRIMPDECAL									REV. A

A

B

C

D

E

A

Hand Pump

Part No. 82C-0HP



(for use with the Minikrimp, Karrykrimp and Karrykrimp 2)

Ease of operation hand pump delivers 10,000 psi

Length: 23"
Width: 4"
Height: 5"
Port Size: 3/8" NPTF
Weight: 9 lbs
Hydraulic Fluid: Enerpac oil

Hand Pump

Part No. 85C-0HP



(for use with the Minikrimp, Karrykrimp and Karrykrimp 2)

Ease of operation hand pump delivers 10,000 psi

Length: 29"
Width: 13"
Height: 11"
Port Size: 3/8" NPTF
Weight: 61 lbs
Hydraulic Fluid: Enerpac oil

B

Electric Pump

Part No. 82C-0EP



(for use with the Minikrimp, Karrykrimp and Karrykrimp 2)

Ease of operation electric pump delivers 10,000 psi

Length: 13"
Width: 13"
Height: 15"
Port Size: 3/8" NPTF
Weight: 31 lbs
Hydraulic Fluid: Enerpac oil
115 volt, 1 phase, 50/60 Hz, 9 amp

Electric Pump

Part No. 85C-0EP



(for use with the Minikrimp, Karrykrimp and Karrykrimp 2)

Heavy duty electric pump delivers 10,000 psi at a faster cycle time

Length: 19"
Width: 11"
Height: 17"
Port Size: 3/8" NPTF
Weight: 59 lbs
Hydraulic Fluid: Enerpac oil
115 volt, 1 phase, 50/60 Hz, 20 amp

C

D

Air/Hydraulic Pump

Part No. 82C-0AP



(for use with the Minikrimp, Karrykrimp and Karrykrimp 2)

Lightweight pump operates with 80-110 psi shop air pressure and delivers 10,000 psi

Length: 15"
Width: 6"
Height: 6"
Intake Port Size: 1/4" NPTF
Output Port Size: 3/8" NPTF
Weight: 14 lbs
Hydraulic Fluid: Enerpac oil

Vehicle Battery-Powered Pump

Part No. 85C-12V



(for use with the Minikrimp, Karrykrimp and Karrykrimp 2)

Ideal unit for Parker Mobile Hose Replacement Service, Delivering 10,000 psi.

Length: 12"
Width: 8"
Height: 19.5"
Weight: 67 lbs
Hydraulic Fluid: ISO-46

E

Enerpac Warranty Statement

Enerpac products are warranted to be free of defects in materials and workmanship. Any product that does not conform to specification will be repaired or replaced at Enerpac's expense, anywhere in the world; simple as that! This warranty does not cover ordinary wear and tear, abuse, misuse, alterations, or the use of improper fluids. Determination of the authenticity of a warranty claim will be made only by Enerpac or its Authorized Service Centers.

www.parker.com/crimpsource

Crimpsource is the industry's most complete resource for crimper technical information. It contains all of the crimp specifications approved for Parker's rubber, industrial and thermoplastic hose:

- Crimp specs
- PDFs of technical manuals for easy downloading
- Parts lists
- Troubleshooting advice
- PDFs of crimper decals for immediate printing

Crimpsource provides easy access to all the specifications necessary to correctly fabricate a factory quality hose assembly.

Crimpsource Spec Page

A series of dropdown menus enables users to find what they need quickly and easily.

Choose your crimper, and then select the hose, fittings and current specifications needed to make hose assemblies.

You can also print a simple-to-follow data specification sheet or crimper decal.

Print your own crimp decals whenever you need to

Crimpsource Home Page

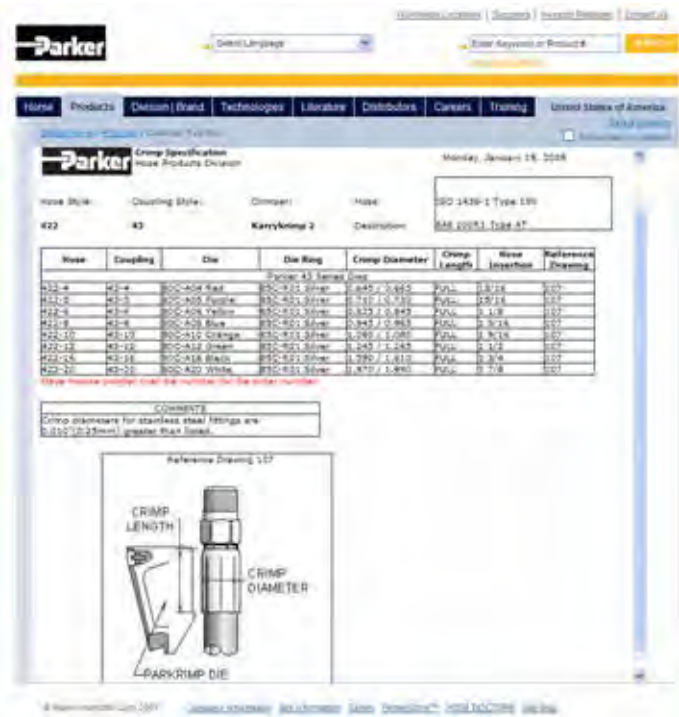
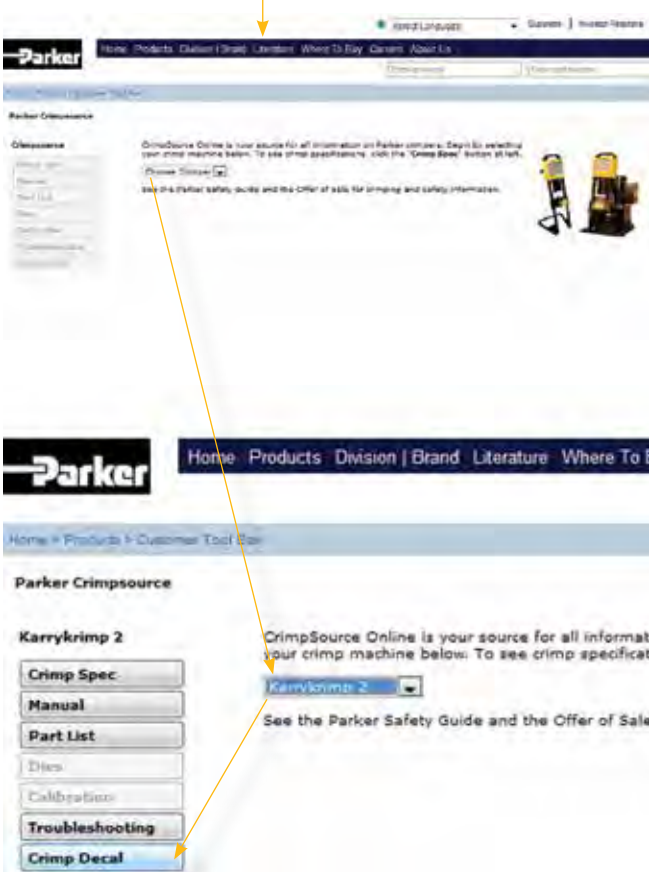

A

B

C

D

E

Crimping using Minikrimp, Karrykrimp, Karrykrimp Bench Mount, Karrykrimp 2 and Karrykrimp 2 Bench Mount

Parkrimp Fittings Series 25, 26, 43, 70, 71, 73, 76, 78, S6, 81, HY

1 Mark insertion depth and push on fitting

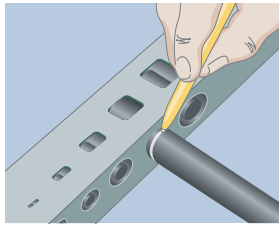

Mark the hose insertion depth and push hose into fitting until the mark on the hose is even with the end of the shell. Lubricate hose if necessary, however, **DO NOT lubricate if using spiral hose.** See Hose Insertion Depth table below.



Place shell onto end of hose and make sure the end of the shell lines up with the Insertion Depth mark.

Push hose onto the 88 Series fitting until the shell bottoms against the fitting's stop ring or hex. Lubricate hose if necessary.

2 Insert unitized die train



Pull pin at the top of pusher to swing it back. Place unitized die-train into base plate. See decal on crimper for proper die set.

Note: Parkrimp 1 does not have a pin at the top of the pusher.

Important: Lubricate the crimper's die bowl using a premium quality lithium-base grease.

Color-Coded Unitized Die-Train

3 Position the fitting

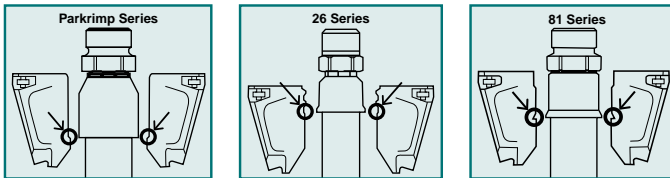

Position the hose and fitting in dies from below. Rest bottom of coupling on die step using the PARKALIGN® feature.

4 Place die ring and crimp



Place correct die ring on top of the dies. See decal on crimper for proper die ring.



Position pusher by replacing the pin and operate pump until the die ring bottoms out. Release pressure within the pump — remove finished assembly.

Note: Minikrimp, Karrykrimp & Karrykrimp 2 have several types of power sources, all of which are separate units from the crimping machine.

5 Measure crimp diameter

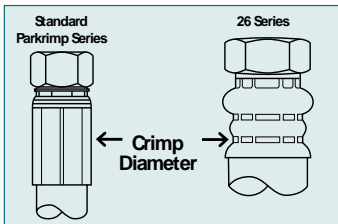

Measure crimp diameter on the flat surfaces of the crimped shell, referenced in the illustration to the left. Reference decal on crimper for crimp diameters. Never use hose assemblies with incorrect crimp diameters.

Important: Hose assemblies must be inspected for cleanliness and free of all foreign particles.

Hose insertion depths

Fitting Size	Fitting Series																											
	25		26		43		70		71		73		77		78		S6		79		81		HY					
	inch	mm	inch	mm	inch	mm	inch	mm	inch	mm	inch	mm	inch	mm	inch	mm	inch	mm	inch	mm	inch	mm	inch	mm				
-4	—	—	13/16	21	13/16	21	—	—	—	—	—	—	—	—	—	—	—	—	—	—	—	—	—	—	1-7/16	37		
-5	—	—	13/16	21	15/16	24	—	—	—	—	—	—	—	—	—	—	—	—	—	—	—	—	—	—	—	—		
-6	7/8	22	13/16	21	1-1/8	29	1-1/16	27	1-1/16	27	—	—	—	—	—	—	—	—	—	—	—	—	—	—	—	1-1/2	40	
-8	7/8	22	13/16	21	1-5/16	33	1-5/16	33	1-1/4	32	—	—	1.36	34.6	—	—	—	—	—	—	—	—	—	—	—	1-9/16	40	
-10	—	—	7/8	22	1-9/16	40	1-3/8	35	1-5/16	33	—	—	1.53	38.9	1-7/8	47	—	—	—	—	—	—	—	—	—	1-9/16	40	
-12	—	—	7/8	22	1-1/2	38	1-1/2	38	1-7/16	37	1-7/8	48	1.78	45.2	1-7/8	48	—	—	2-3/16	56	1-1/8	29	1-5/8	40	—	—	—	
-16	—	—	1	25	1-3/4	44	1-13/16	46	1-3/4	44	2	51	2.13	54.1	2	51	—	—	2-5/16	59	1-1/4	32	1-3/4	43	—	—	—	
-20	—	—	1	25	1-7/8	48	1-3/4	44	1-13/16	46	2-1/2	64	2.51	63.8	2-1/2	64	—	—	2-13/16	71	1-5/16	33	—	—	—	—	—	
-24	—	—	1-1/16	27	1-7/16	37	—	—	2-5/16	59	2-7/16	62	—	—	2-7/16	62	—	—	—	—	—	—	—	—	—	—	—	—
-32	—	—	1-1/4	32	1-13/16	46	—	—	2-7/16	62	2-13/16	71	—	—	—	—	—	—	3-1/2	88	—	—	—	—	—	—	—	

For specific information on crimping, visit Crimpsource™ online at www.parker.com/crimpsource.

Crimping using Superkrimp and Parkrimp 2

Parkrimp Fittings Series 25, 26, 43, 70, 71, 73, 76, 78, S6, 81, HY

1 Mark insertion depth and push on fitting

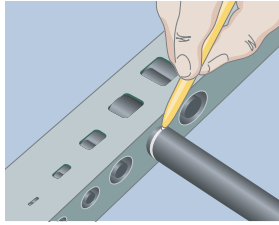

Mark the hose insertion depth and push hose into fitting until the mark on the hose is even with the end of the shell. Lubricate hose if necessary, however, **DO NOT lubricate if using spiral hose.** See Hose Insertion Depth table on previous page.

For 81 Series Shells with 88 Series Fittings

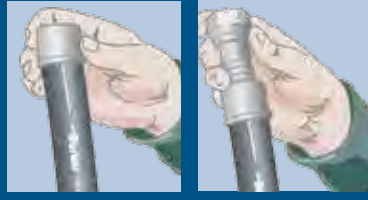

Place 81 Series Shell onto end of hose and make sure the end of the shell lines up with the Insertion Depth mark.

Push hose onto the 88 Series fitting until the shell bottoms against the fitting's stop ring or hex. Lubricate hose if necessary.

2a If using large two-piece dies

Insert the proper die set into the die bowl. (The die sets are in two halves of four dies each. Place one half in the back and one half in the front to accommodate bent tube fittings.) Reference decal on crimper for proper tool selection.



2b If using small unitized dies

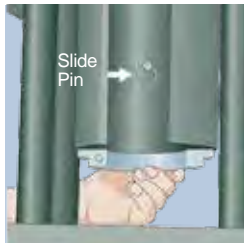

With the pusher in the full up position, lift the back half of the split die ring. Lock it in the up position by pushing the slide pin in. (The slide pin is located inside the pusher at the back.)



Lubricate die bowl using a premium quality lithium-base grease. Carefully insert the adapter bowl, 83C-OCB, into the base bowl. The adapter bowl must be tilted toward the back of the crimper during insertion.

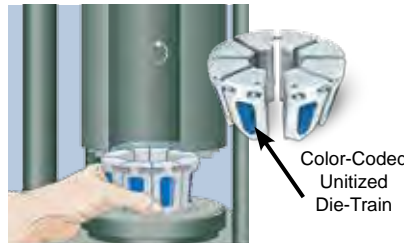

Lubricate die bowl using a premium quality lithium-base grease. Place unitized die-train into the adapter bowl. Select die and die ring by hose size and type. See decal on crimper for proper die set.

Note: Die sets have color-coded cavities indicating size and have the fitting series and dash size stamped on the top.

3 Place spacer ring



If required, place spacer ring on locating step of adapter bowl. Reference decal on crimper for tool selection.

4 Position the split die ring



Lower the back half of the split die ring onto the dies by pulling the slide pin forward.

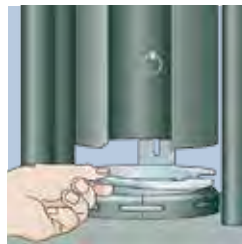

Insert the front half of the split die ring aligning the pins in the back half with the hole in the front half.

5 Position the fitting

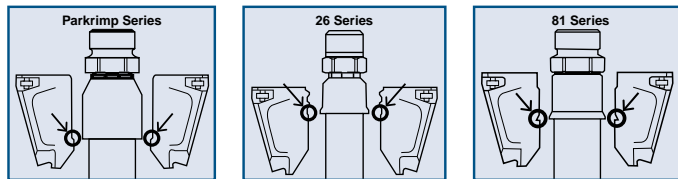

Position the hose and fitting in dies from below. Rest bottom of coupling on die step using the PARKALIGN® feature.

6 Crimp hose

Turn on the pump by pressing the "ON" switch. Pull the valve handle forward to bring the pusher down for crimping. When the split die ring contacts the base plate, the crimp is complete. Push the valve handle back to lift the pusher, open the dies, and release the finished assembly.

Note: You do not have to remove any tooling to insert or remove straight fittings. The front half of the split die ring and the front die train must be removed to insert and remove bent tube fittings.



7 Measure crimp diameter

Measure crimp diameter on the flat surfaces of the crimped shell, referenced in the illustration to the right. Reference decal on crimper for crimp diameters. Never use hose assemblies with incorrect crimp diameters.

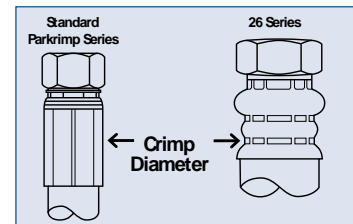

Important: Hose assemblies must be inspected for cleanliness and free of all foreign particles.

Assembling Twin Tough Rubber Hose

A

Required Equipment:

Twin Tough hose, fittings, knife, tape measure, heat shrink sleeve, scissors, grease pencil, heat gun, and calipers.



B

Set-up:

Position the bonded rubber hose so that it lies flat on a work surface without tendency to twist or turn.

Measure hose tear back length:

Measure and mark the length that the hoses are to be separated. A minimum of 12 inches is required for crimping the hose ends. A 24 inch tear back is recommended for use with hydraulic tools.



C

Note: If length of separation/tear back is specified from the threaded or swivel nut end of the coupling, then deduct the cut off allowance dimension for the specific style of coupling used. The cutoff allowance can be obtained from the hose fitting tables in the 4400 Catalog "B" dimension, or can be calculated by subtracting the insertion depth of the shell from the overall coupling length.

Cut hose tear back to length:

Press the bonded hose assembly firmly and flat against the work surface with your free hand so that it does not move.

D

A.) Using a sharp blade, pierce the center of the valley (web) formed by the hoses.



B.) To start the cut, place the blade in the center of that valley (web) drawing the knife with constant pressure.



C.) Once you have a 1 to 2 inch starter cut, firmly pull each hose end apart to your required separation length.



E

Note: It is important that the knife blade be perpendicular to the hose during this procedure so the blade cuts only the centerline of the valley (web). EXTREME CARE MUST BE TAKEN TO AVOID CUTTING THROUGH THE COVER OF THE HOSES AND THEREBY EXPOSING THE HOSE REINFORCEMENT. If this occurs, the hose assembly must be discarded.

Measure Separation: It is suggested that the separation length be at least 12 inches, so the crimping operation can be accomplished without risk of kinking the hoses.



Stopping Separation: Parker recommends installing a heat shrink sleeve of at least 2 inches in length at the termination of the separated hose to provide protection against tearing of the valley (web) or hose covers. This heat shrink sleeve should be placed on the hose assembly prior to the crimping of the hose fittings. Once you have your heat shrink sleeve in place, use a heat gun to shrink the sleeve in place.



Note: EXTREME CARE MUST BE TAKEN TO AVOID EXPOSING THE HOSE ASSEMBLY TO THE DIRECT HIGH TEMPERATURES OF THE HEAT GUN WHILE INSTALLING THE HEAT SHRINK SLEEVE. LONG EXPOSURE FROM A HEAT GUN MAY ADVERSLEY AFFECT THE HOSE INNERTUBE OR ITS COVER.

Crimping Fittings: All of your crimping information can be found on Crimpsource (www.parker.com/crimpsource).

First, place your fittings onto each hose end making sure that both have been installed to the correct hose insertion depth. Choose the correct die and die ring. Place half of your hose assembly through the bottom of your Parkrimp crimper. Rest the bottom of the fitting on the die step using the Parkalign system. While lightly holding the hose assembly, operate your crimper pump so that the pusher on the crimper comes down in contact with the die ring until it bottoms out on the crimper base. Then release the pressure within the pump and remove the first half of your finished assembly. Always measure your hose assemblies for the correct crimp diameter. Now, repeat the crimping process on the other fitting.



Note: EXTREME CARE MUST BE TAKEN TO AVOID KINKING THE HOSE THAT IS NOT BEING CRIMPED DURING THIS PROCESS.

A

B

C

D

E

A



Hydraulic Press Kit

Part No. 8PC-001

For use with 26, 43, 81 and HY Series Fitting ONLY

Specifications

- Required Height from Press Base to Press Ram: 10 inches
- Required Width of Bowl Diameter: 5 inches
- Bowl Rating: 30 tons force maximum
- Minimum Required Press Capacity: Hose Size 1/4" to 1/2" needs a 20 ton press
Hose size 5/8" to 1-1/4" needs a 30 ton press

Standard Equipment

Part Number	Description	Individual Part Number
8PC-001		
●	Bowl Assembly	8PC-030
●	Pusher	8PC-00P
●	Silver Die Ring	81C-R01
●	Black Die Ring	81C-R02
●	43 Series dies in 1/4", 3/8", 1/2", 3/4" and 1"	80C-Axx

B

Weatherhead Conversion Kit

Part No. 8WC-001

For use with 26, 43, 81 and HY Series Fitting ONLY

Convert **Weatherhead T-400 crimper** to utilize Parker Parkrimp No-Skive fittings.

Standard Equipment

Part Number	Description	Individual Part Number
8WC-001		
●	Bowl Assembly	8PC-030
●	Pusher	8WC-00P
●	Silver Die Ring	81C-R01
●	Black Die Ring	81C-R02
●	43 Series Dies in 1/4", 3/8", 1/2" and 3/4"	80C-Axx

C



D

Gates Conversion Kit

Part No. 8GC-002

For use with 26, 43, 81 and HY Series Fitting ONLY

Convert **Gates 701, 703 and 707 bottom loading crimpers** to utilize Parker Parkrimp No-Skive fittings.

Standard Equipment

Part Number	Description	Individual Part Number
8GC-002		
●	Bowl Assembly	8PC-030
●	Silver Die Ring	81C-R01
●	Black Die Ring	81C-R02
●	43 Series Dies in 1/4", 3/8", 1/2", 3/4" and 1"	80C-Axx

E



Notes:

- For additional information and operating instructions, visit the Parker Hose Products Division website at www.parkerhose.com.
- For crimping instructions, see pages C-18 and C-19.
- Hose assemblies must be inspected for cleanliness and free of all foreign particles.

Hose Cut-Off Machine - Karrykut

Part No. 631075



Features

- Portable saw for cutting on the job
- Unique clamp system spreads hose as it cuts to prevent blade binding
- Cuts multi-braided wire reinforced hose including 4 spiral construction up to 1-1/4" I.D.

Specifications

- Dimensions: 16" wide x 12" long x 19" high
- Shipping Weight: 58 lbs.

Standard Equipment

Part Number	Description	Individual Part Number
631075		
●	Power saw with 115volt (13 amp) universal AC motor	631140
●	Universal clamp attachment (can be used with any portable power saw unit having a 5/8" arbor, 7" blade capacity)	631076
●	Cutting blade (7" with 5/8" arbor size)	621102

Hose Cut-Off Machine

Part No. TH3-51



Features

- Standard 14" scalloped blade
- Front plate with useable pins easily holds in place for a straight cut
- Clear face shield
- Cuts 1 & 2 wire braid through 2" I.D., 4-wire spiral through 2" I.D., and 6-wire spiral through 1" I.D.

Specifications

- 4.5 HP/115 volts 20 amp 1PH 50/60 cycle motor (a 20 amp dedicated circuit is recommended)
- Dimensions - 22-1/2" wide x 13" long x 25-1/2" high
- Shipping weight - 67 lbs.
- Blade size - 14" x 0.125" x 1"

Saw Part Number: TH3-51

- Optional Equipment:
- Scalloped Cutting Blade (TH3-50-1)
- Smooth Bevel Cutting Blade (TH3-50-2)

Hose Cut-Off Machine

Part No. 332T-115V



Features

- For quick, easy cutting of spiral reinforced hose up to 1-1/4" I.D.
- Moving parts shielded by guards

Specifications

- Dimensions: 13" wide x 26" long x 22" high
- Shipping Weight: 71 lbs.

Standard Equipment

Part Number	Description	Individual Part Number
332T-115V		
●	Hose Cut-Off Machine with 1-1/2 HP, 3450 RPM, 115/230V single phase electric motor wired for 115V	
●	Scalloped Cutting Blade (8" with 5/8" arbor size)	24398

Optional Equipment

- Smooth Cutting Blade (580661)

Hose Cut-Off Machine

Part No. 239 and 339



Features

- Designed for heavy duty use
- Cuts multi-braided wire reinforced hose including 6 spiral construction up to 2" I.D.

Specifications

- Dimensions: 22" wide x 42" long x 24" high
- Shipping Weight: 115 lbs.

Standard Equipment

Part Number		Description	Individual Part Number
239	339		
●		Hose Cut-Off Machine with 230V single phase motor	
	●	Hose Cut-Off Machine with 3 HP motor 230V, 3 phase, 60 cycle	
●	●	Scalloped Cutting Blade (10" with 3/4" arbor size)	24248

Optional Equipment

- Smooth Cutting Blade (15960)



Ultra Clean Hose Cleaning Kit

Economy Hose Cleaning Kit

A



Part No. TH6-10-HL-9-2



Part No. TH6-10-EL-7

B

Features

- Capable of cleaning 1/4" through 2" hose, tube or pipe
- The launcher is supplied with a Full-Flow Quick Release Coupling and unique 360° Rotary Plug for proper air flow and non-fatigue operator use
- Unique Safety Release Bar that locks the faceplate into a closed position for firing Ultra Clean projectiles

Air Requirements:

- 80 PSI (5.5 Bar) minimum to 110 PSI (7.5 Bar) maximum
- 1/2" I.D. air hose
- 5 micron filter and regulator with gauge are strongly suggested



C

Economy Kit Features

- Capable of cleaning 1/4" through 1-1/4" hose, tube or pipe
- Has a quarter-turn locking ring for easy nozzle change and projectile loading
- The launcher is constructed of durable brass and aluminum internals, strong plastic handle, and anodized aluminum firing head and locking ring.
- Ideal for mobile and job site applications because of its size and portability

Air Requirements:

- 80 PSI (5.5 Bar) minimum to 110 PSI (7.5 Bar) maximum
- 1/2" I.D. air hose
- 5 micron filter and regulator with gauge are strongly suggested

D

E

Optional Equipment & Accessories:

- A range of projectiles are available enabling the Ultra Clean System to be used on different sizes and types of hose, as well as coupling configurations
- Additional nozzles for JIC, Code 61 and Code 62 flanges, and ORFS are also available if required

Ultra Clean Hose Cleaning Kit

Sizing Chart and Part Numbers

HOSE ONLY		
Hose Size	Nozzle Part Number	Projectile Part Number
3/16"	TH6-10-H06	TH6-10-P06
1/4"	TH6-10-H06	TH6-10-P10
3/8"	TH6-10-H10	TH6-10-P14
1/2"	TH6-10-H13	TH6-10-P18
5/8"	TH6-10-H16	TH6-10-P22
3/4"	TH6-10-H19	TH6-10-P26
1"	TH6-10-H25	TH6-10-P33
1-1/4"	TH6-10-H32	TH6-10-P40
1-1/2"	TH6-10-H38	TH6-10-P50
2"	TH6-10-H50	TH6-10-P60

HOSE ASSY W/FJIC		
FJIC Size	Nozzle Part Number	Projectile Part Number
1/4"	TH6-10-J06	TH6-10-P06
3/8"	TH6-10-J10	TH6-10-P12
1/2"	TH6-10-J13	TH6-10-P16
5/8"	TH6-10-J16	TH6-10-P22
3/4"	TH6-10-J19	TH6-10-P26
1"	TH6-10-J25	TH6-10-P33
1-1/4"	TH6-10-J32	TH6-10-P40
1-1/2"	TH6-10-J38	TH6-10-P50
2"	TH6-10-J50	TH6-10-P60

HOSE ASSY W/FFORX		
FFORX Size	Nozzle Part Number	Projectile Part Number
1/4"	TH6-10-4FFORX	TH6-10-P06
3/8"	TH6-10-H06	TH6-10-P12
1/2"	TH6-10-H10	TH6-10-P16
5/8"	TH6-10-H13	TH6-10-P22
3/4"	TH6-10-H16	TH6-10-P26
1"	TH6-10-H19	TH6-10-P33
1-1/4"	TH6-10-H25	TH6-10-P40

HOSE ASSY W/Code 61 & 62 Flanges		
Flange Size	Nozzle Part Number	Projectile Part Number
1/2"	TH6-10-H10	TH6-10-P16
3/4"	TH6-10-H16	TH6-10-P26
1"	TH6-10-H19	TH6-10-P33
1-1/4"	TH6-10-H25	TH6-10-P40
1-1/2"	TH6-10-H32	TH6-10-P50
2"	TH6-10-H38	TH6-10-P60

PROJECTILE QUANTITIES		
Parker Part Number	Description	Qty.
TH6-10-P06	PROJECTILE 3/16"	100 PER BAG
TH6-10-P10	PROJECTILE 1/4"	100 PER BAG
TH6-10-P12	PROJECTILE 1/4" AND 5/16"	100 PER BAG
TH6-10-P14	PROJECTILE 3/8"	100 PER BAG
TH6-10-P16	PROJECTILE 3/8"	100 PER BAG
TH6-10-P18	PROJECTILE 1/2"	100 PER BAG
TH6-10-P22	PROJECTILE 5/8"	50 PER BAG
TH6-10-P26	PROJECTILE 3/4"	50 PER BAG
TH6-10-P33	PROJECTILE 1"	40 PER BAG
TH6-10-P40	PROJECTILE 1-1/4"	30 PER BAG
TH6-10-P50	PROJECTILE 1-1/2"	20 PER BAG
TH6-10-P60	PROJECTILE 2"	15 PER BAG



A

Hose Cut-Off Tool - Handykut

Part No. 871522



Features

- Portable tool for efficient cutting of hose
- Can be positioned onto a flat surface by clamps or by locking it in a vise, properly align the hose in a radius and cut it with a hacksaw

Specifications

- Dimensions: 6" wide x 18" long x 6" high
- Shipping Weight: 10 lbs.

B

Push-Lok Cut-Off & Assembly Tool

Part No. 881540



Features

- Combined hose cutter and toggle action press that cuts and assembles Parker Push-Lok in sizes 1/4" through 3/4" I.D.

Specifications

- Dimensions: 16" long
- Shipping Weight: 4 lbs.

C

Hose Insertion Depth Blocks

Part No. TH9-1-XXX



Features

- For quick easy marking of hose insertion depth
- Ensures accuracy and increased productivity

Available Blocks

Part Number	Description
TH9-1-26A	26 Series -4 through -10
TH9-1-26B	26 Series -12 through -32
TH9-1-43A	43 Series -4 through -10
TH9-1-43B	43 Series -12 through -32
TH9-1-70	70 Series -6 through -20
TH9-1-71	71 Series -6 through -32
TH9-1-73	73 Series -12 through -32
TH9-1-77	77 Series -8 through -16
TH9-1-78	78 Series -12 through -32
TH9-1-79	79 Series -12 through -24
TH9-1-HY	HY Series -4 through -16

D

Hose Cut-Off Tool

Part No. TH11-1



Features

- Designed for quick, easy cutting of textile reinforced hose.
- Squarely cuts Push-Lok hose in sizes 1/4" through 3/4" I.D.

Specifications

- Dimensions: 8" long
- Shipping Weight: 0.3 lbs.

E

Hozemblem

Part No. 432-115V



Features

- Power machine to facilitate the attachment of field attachable fittings
- Handles all hose and fittings up to 4 spiral wire, in sizes 3/16" through 2" I.D., including bent tube elbows
- Comes with vise, all adapters, foot switch and safety guard with 115V, 30 amp, universal AC motor

Specifications

- Shipping Weight: 141 lbs.

Optional Parts

- Mounting stand (662451)

Die Storage Racks

Part No. 80C-0DR and 83C-0DR



Features

- Modular die rack designed to hold small and large Parkrimp dies
- Can be bolted together to a work bench horizontally or vertically

Standard Equipment

Part Number		Description
80C-0DR	83C-0DR	
●		Storage of three sets of small dies
	●	Storage of two sets of large dies

A

B

C

D

E

Swivel Die Rack

Part No. 80C-SDR-XXXX



Features

- Holds up to 30 Parkrimp dies of any size
- Powder-coated, heavy-duty steel construction
- Consists of a base unit and up to five circular holders
- Floor or bench mounted

Standard Equipment

Part Number	Description
80C-SDR-SM	Swivel Die Rack and Small Die Holder
80C-SDR-LG	Swivel Die Rack and Large Die Holder
80C-SDR-BASE	Swivel Die Rack Base

Fitting Push-On Stand

Part No. TH2-7



Features

- Quickly and easily pushes fittings onto hose
- Boosts productivity and quality
- Eliminates the need of rubber mallets and oils to get fittings onto the end of the hose for crimping
- Standard with straight tooling required for sizes 1/4" through 2" for all crimped fittings, 82 Series Push-Lok and 88 Series field attachable fittings

Specifications

- Shipping Weight: 200 lbs.

Optional Tooling

- Elbow Pusher Set (TH2-7-ELS)

A

Mandrel Tool Kit - 22 Series

Part No. 652200



Features

- For assembly of Parker 22 Series field attachable fittings
- One of each part listed below is included in the kit

Standard Equipment

Hose I.D.	Dash Size	SAE (JIC) 37°	SAE 45°
3/16	-4	●	●
1/4	-5	●	●
5/16	-6	●	●
13/32	-8	●	●
1/2	-10	●	●
5/8	-12	●	●

B

C

D

E

Mandrel Tool Kit - 23 Series

Part No. 2727 and 2726



Features

- For assembly of Parker 23 Series field attachable fittings
- Part No. 2727 is for JIC 37° flared fittings
- Part No. 2726 is for SAE 45° and PTT 30° flared fittings

Standard Equipment

Hose I.D.	Dash Size	2727	2726
3/16	-4	●	●
1/4	-5	●	●
5/16	-6	●	●
13/32	-8	●	●
1/2	-10	●	●
5/8	-12	●	●
7/8	-16	●	●

Mandrels - 25 Series

(For 271 Transportation Hose)

Part No. TH2-7M25-6 and TH2-7M25-8



Assembly Tools - 22 Series

Part No. 652201



Features

- For assembly of Parker 22 Series field attachable fittings
- One of each part listed below is included in the kit

Standard Equipment

Hose I.D.	Dash Size	SAE (JIC) 37°	SAE 45°
7/8	-16	●	●
1-1/8	-20	●	●
1-3/8	-24	●	●
1-13/16	-32	●	●

Hose Perforator

Part No. 601069



Features

- Small hand tool to prick minute holes in the rubber cover
- To be used in gaseous applications where the pressure exceeds 250 psi
- Driven into the cover every few inches of length either striking the hose or by a rolling action over the hose cover
- Not generally necessary to perforate the hose on all sides

Specifications

- Shipping Weight: 2 lbs.

Hose Oil

Part No. Hose Oil



Features

- Reduces torque and eliminates waste lubrication
- Use hose oil with the recommended hose assembly instructions

Accrolube

Part No. Accrolube



Features

- High efficiency lubricant used for stainless steel field attachable fittings
- Contains Teflon to reduce the wear between metal surfaces, protects against corrosion and ultimately eliminates galling

Small Crimper Hood

Part No. 82C-CVR



Features

- Water repellent
- UV protected
- Perfect for indoor and outdoor applications

Fits

- Karrykrimp, Parkrimp
Karrykrimp2, Minikrimp

Large Crimper Hood

Part No. 83C-CVR



Features

- Water repellent
- UV protected
- Perfect for indoor and outdoor applications

Fits

- PHastkrimp, Superkrimp
Parkrimp2

A

B

C

D

E

A

B

C

D

E













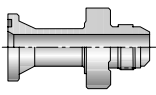
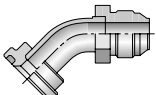
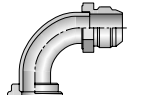
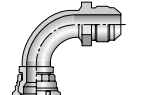
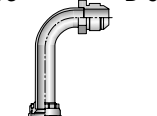
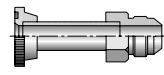
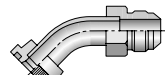
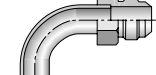
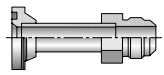
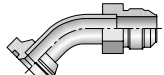
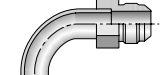
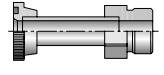
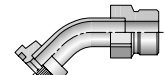
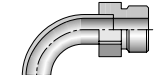
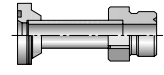
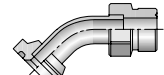
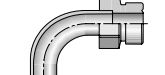
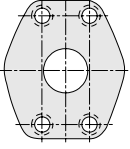
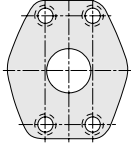



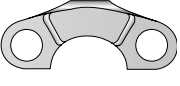
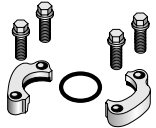



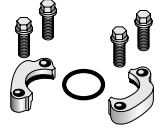
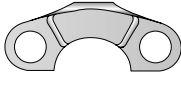



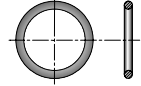

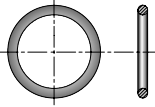
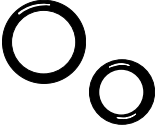
More of what you need to work smarter, faster, and better. Visit www.parkerhose.com for up-to-the-minute accessory selections.

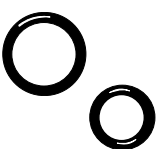
Accessories

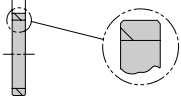
D



ENGINEERING YOUR SUCCESS.

A			15T3 D-5  Straight	17T3 D-5  45° Elbow	19T3 D-5  90° Elbow	39T3 D-6  Swivel Nut 90° Tube Elbow	41T3 D-6  Swivel Nut 90° Tube Elbow - Long	
	4AH3 D-6  Straight	4FH3 D-7  45° Elbow	4NH3 D-7  90° Elbow	6AH3 D-7  Straight	6FH3 D-7  45° Elbow	6NH3 D-8  90° Elbow		
	4AJM D-8  Straight	4FJM D-8  45° Elbow	4NJM D-8  90° Elbow	6AJM D-9  Straight	6FJM D-9  45° Elbow	6NJM D-9  90° Elbow		
	Standard Pressure (Code 61) D-10 	High Pressure (Code 62) D-10 	50H D-10  Flange Half 5000 psi (Code 61)	5050HK D-11  Flange 5000 psi (Code 61) Kit	51H D-11  Flange Half (Code 61)	5151HK D-11  Flange (Code 61) Kit		
	HFH D-12  Flange Half (Code 62)	HFHFHK D-12  Flange (Code 62) Kit	8FH D-12  Flange Half (8000 psi)	8FHFHK D-12  Flange Kit (8000 psi)	FFK61 D-13  Full Flange Kit	M1H D-14  ISO (Code 61)		
	M1M1HK D-14  ISO (Code 61) Kit	M2H D-15  ISO (Code 62)	M2M2HK D-15  ISO (Code 62) Kit	XCXCHK D-15  CAT Flange Kits			711509 D-16  	
711510 D-16 	C9RG D-16  O-Rings for CA, CE, CF Metric	C9RG D-16  O-Rings for C9, OC, 1C Metric Swivels	D9DT D-16  Bonded Seal for BSPP Port Fittings	JORG D-17 	XARG D-17  Flange "D" Rings Caterpillar® Style Flanges			
8ARG D-17  Flange "D" Rings	59RG D-18  Tube O-Ring Fittings and Compressor Fittings	T1RG D-18  O-Rings for Compression Fittings (IT126)	CORG D-18 			Partek Wrap D-19 		

Partek Sleeve D-20 	PolyGuard (HG) D-21 	ParKoil™ (PG) D-21 	Spring Guard (SG) D-22 Armor Guard (AG) 	Polyguard D-22 Strain Reliever 	Firesleeve (FS-F) D-23 	
FSC Clamp D-23 	Firesleeve Accessories D-24 	Firesleeve Assembly Instructions D-24 	CL Clamp D-25 	HC Clamp D-26 	88HC-H Clamp D-26 	
88DB Clamp D-26 	Protection Shields D-27 	Hose Assembly Workstations 		Hose Assembly D-28 Workstations 	HoseFab Table D-29 	Rotary Reel Rack D-29 
Saw Table D-29 	3/4 Reel Rack D-29 	Parker Kart D-30 	72B-Cabinet D-30 	HR6 Hose Bin D-30 	Hose Adapters 	
Hose Adapters D4 						

A

B

C

D

E

SAE/NPT/Metric Hose Adapters

A



O-Ring Face-Seal Seal-Lok™

Sizes: 6 mm – 38 mm
Materials: Steel, Stainless Steel
Pressures: Up to 9200 psi

O-Ring Face-Seal Metric Seal-Lok™

Sizes: 1/4" – 2"
Materials: Steel, Stainless Steel
Pressures: Up to 9200 psi

37° Flare Fittings Triple-Lok®

Sizes: 1/8" – 2"
Materials: Steel, Stainless Steel, Brass
Pressures: Up to 9000 psi

37° Flare Metric Triple-Lok®

Sizes: 6 mm – 38 mm
Materials: Steel, Stainless Steel
Pressures: Up to 7200 psi

Pipe Fittings and Port Adapters

Sizes: 1/8" – 2"
Materials: Steel, Stainless Steel, Brass
Pressures: Up to 7200 psi

Conversion Adapters

Sizes: 1/4" – 1-1/2"
Materials: Steel, Stainless Steel
Pressures: Up to 7700 psi

B



Pipe Swivels

Sizes: 1/8" – 2"
Materials: Steel, Stainless Steel
Pressures: Up to 5000 psi

Hydraulic Flange and Flange Adapters

Sizes: 3/4" – 3"
Materials: Steel, Stainless Steel
Pressures: Up to 6000 psi

Japanese Industrial Standard JIS

Sizes: 1/4" – 1"
Materials: Steel
Pressures: Up to 5000 psi

30° Flare Komatsu Style

Sizes: M14 x 1.5 – M33 x 1.5
Materials: Steel
Pressures: Up to 4000 psi

60° Cone BSPP K4

Sizes: 1/8" – 2"
Materials: Steel
Pressures: Up to 5000 psi

C

D

How to Order Parker Hose Adapters

When ordering Parker Adapters, please state the Catalogued Number of each type of adapter desired. Be sure to double check tube and hose sizes of items required.

To select proper seal materials for specific applications, refer to Media Compatibility Chart in Tube Fitting Catalog 4300, or contact your Parker Tube Fitting Distributor.

If in doubt about which type or size of fitting to specify, consult your Parker Tube Fitting Distributor. In addition Parker Field Sales, Technical Services, the Tube Fitting Division and your local Parker Service Center will help you find answers to all your issues.

Phone: (614) 279-7070

Fax: (614) 279-7685

Web: <http://www.parker.com/tfd>

Note: Refer to **Parker Catalog 4300** for more detailed application information.

CALL TOLL-FREE 1-800-C PARKER (1-800-272-7537)

Parker Information Center for catalogs, literature or additional information.

E

15T3

SAE (Code 61) Flange – Male SAE (JIC) 37° Flare

# Part Number	Flange inch	Thread		A		W inch	F inch
		T1		inch	mm		
15T3-8-8	1/2	1/2	3/4x16	2.80	71	1-1/4	1-3/16
15T3-12-12	3/4	3/4	1-1/16x12	3.20	81	1-9/16	1-1/2
15T3-16-12	1	3/4	1-1/16x12	2.68	47	1-1/8	1-3/4
15T3-16-16	1	1	1-5/16x12	3.22	82	1-7/8	1-3/4
15T3-20-16	1-1/4	1	1-5/16x12	2.76	51	1-3/8	2
15T3-20-20	1-1/4	1-1/4	1-5/8x12	3.69	94	2-1/4	2
15T3-24-24	1-1/2	1-1/2	1-7/8x12	4.04	103	2-1/2	2-3/8
15T3-32-32	2	2	2-1/2x12	4.44	113	2-7/8	2-13/16

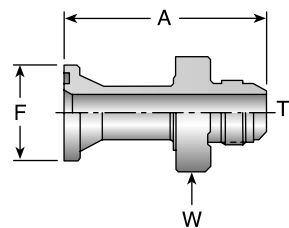

17T3

SAE (Code 61) Flange – Male SAE (JIC) 37° Flare - 45° Elbow

# Part Number	Flange inch	Thread		A		E		W inch	F inch
		T1		inch	mm	inch	mm		
17T3-8-8	1/2	1/2	3/4x16	2.54	65	0.78	20	13/16	1-3/16
17T3-12-12	3/4	3/4	1-1/16x12	2.76	70	1.00	25	1-9/16	1-1/2
17T3-16-12	1	3/4	1-1/16x12	2.76	70	1.00	25	1-1/8	1-3/4
17T3-16-16	1	1	1-5/16x12	2.99	76	1.06	27	1-3/8	1-3/4
17T3-20-16	1-1/4	1	1-5/16x12	2.99	76	1.06	27	1-7/8	2
17T3-20-20	1-1/4	1-1/4	1-5/8x12	3.22	82	1.12	28	1-11/16	2
17T3-24-20	1-1/2	1-1/4	1-5/8x12	3.26	83	1.17	30	1-11/16	2-3/8
17T3-24-24	1-1/2	1-1/2	1-7/8x12	3.43	87	1.12	28	2	2-3/8
17T3-32-32	2	2	2-1/2x12	4.02	102	1.25	32	2-5/8	2-13/16

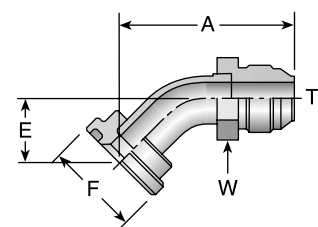

19T3

SAE (Code 61) Flange – Male SAE (JIC) 37° Flare - 90° Elbow

# Part Number	Flange inch	Thread		A		E		W inch	F inch
		T1		inch	mm	inch	mm		
19T3-8-8	1/2	1/2	3/4x16	1.92	49	1.62	41	13/16	1-13/16
19T3-12-12	3/4	3/4	1-1/16x12	2.46	62	2.12	54	1-1/8	1-1/2
19T3-16-12	1	3/4	1-1/16x12	2.46	62	2.12	54	1-3/8	1-3/4
19T3-20-12	1-1/4	3/4	1-1/16x12	2.46	62	2.12	54	1-3/8	2
19T3-16-16	1	1	1-5/16x12	2.79	71	2.37	60	1-3/8	1-3/4
19T3-20-16	1-1/4	1	1-5/16x12	2.79	71	2.37	60	1-3/8	2
19T3-24-16	1-1/2	1	1-5/16x12	2.79	71	2.44	62	1-11/16	2-3/8
19T3-20-20	1-1/4	1-1/4	1-5/8x12	3.12	79	2.50	64	1-11/16	2
19T3-24-20	1-1/2	1-1/4	1-5/8x12	3.12	79	2.56	65	1-11/16	2-3/8
19T3-20-24	1-1/4	1-1/2	1-7/8x12	3.48	88	2.69	68	2	2
19T3-24-24	1-1/2	1-1/2	1-7/8x12	3.48	88	2.75	70	2	2-3/8
19T3-32-24	2	1-1/2	1-7/8x12	3.48	88	2.75	70	2	2-13/16
19T3-32-32	2	2	2-1/2x12	5.61	142	4.50	114	2-5/8	2-13/16

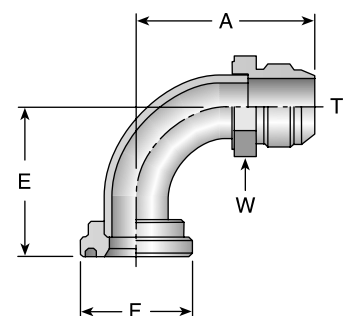

Caution: Do not use the T3 flange to tube or swivel nut to tube adapter in hose assembly applications in which pressures exceed the SAE100R2 working pressure range.

39T3

Male - Female Swivel - SAE (JIC) 37° - 90° Elbow

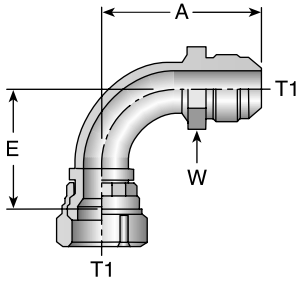

# Part Number	Thread		A		E		W
	inch	T1	inch	mm	inch	mm	inch
39T3-6-6	3/8	9/16x18	1.61	41	0.85	22	5/8
39T3-8-8	1/2	3/4x16	1.86	47	1.09	28	13/16
39T3-10-10	5/8	7/8x14	2.13	54	1.24	31	15/16
39T3-12-12	3/4	1-1/16x12	2.62	67	1.81	46	1-1/8
39T3-16-16	1	1-5/16x12	2.94	75	2.14	54	1-3/8
39T3-20-20	1-1/4	1-5/8x12	3.12	79	2.59	66	1-11/16

41T3

Male - Female Swivel - SAE (JIC) 37° - 90° Elbow - Long

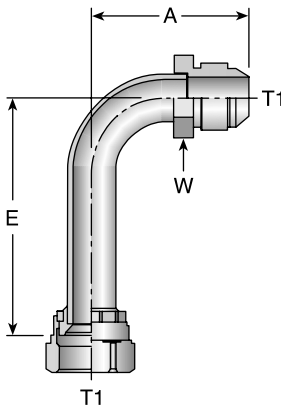

# Part Number	Thread		A		E		W
	inch	T1	inch	mm	inch	mm	inch
41T3-8-8	1/2	3/4x16	1.94	49	2.43	62	13/16
41T3-10-10	5/8	7/8x14	2.20	56	2.57	65	15/16
41T3-12-12	3/4	1-1/16x12	2.50	64	3.74	95	1-1/8
41T3-16-16	1	1-5/16x12	2.79	71	4.23	107	1-3/8

4AH3

SAE Code 61 Flange - Male SAE (JIC) 37° Flare - 5000 psi

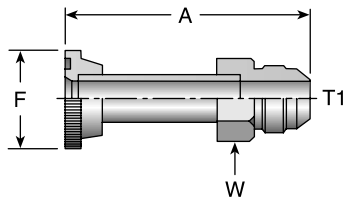

# Part Number	Flange	Thread		A		W	F
	inch	inch	T1	inch	mm	inch	inch
4AH3-12-12	3/4	3/4	1-1/16x12	3.82	97	1-1/8	1-1/2
4AH3-16-16	1	1	1-5/16x12	4.09	104	1-3/8	1-3/4
4AH3-20-20	1-1/4	1-1/4	1-5/8x12	4.16	106	1-3/4	2
4AH3-24-24	1-1/2	1-1/2	1-7/8x12	4.97	126	2	2-3/8

Caution: Do not use the T3 flange to tube or swivel nut to tube adapter in hose assembly applications in which pressures exceed the SAE100R2 working pressure range.

4FH3

SAE Code 61 Flange - Male SAE (JIC) 37° Flare - 5000 psi - 45° Elbow

# Part Number	Flange		Thread T1		A		E		W	F
	inch				inch	mm	inch	mm	inch	inch
4FH3-12-12	3/4		3/4	1-16x12	3.39	86	1.06	27	1-1/8	1-1/2
4FH3-16-16	1		1	1-5/16x12	3.85	98	1.27	32	1-3/8	1-3/4
4FH3-20-20	1-1/4		1-1/4	1-5/8x12	4.22	107	1.36	35	1-3/4	2

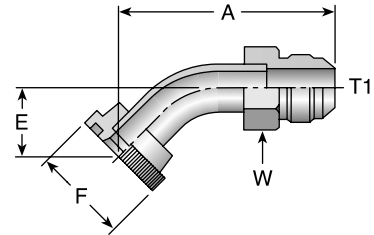

4NH3

SAE Code 61 Flange - Male SAE (JIC) 37° Flare - 5000 psi - 90° Elbow

# Part Number	Flange		Thread T1		A		E		W	F
	inch				inch	mm	inch	mm	inch	inch
4NH3-8-8	1/2		1/2	3/4x16	1.93	49	1.68	43	13/16	1-13/16
4NH3-12-12	3/4		3/4	1-1/16x12	3.07	78	2.24	57	1-1/8	1-1/2
4NH3-16-16	1		1	1-5/16x12	3.25	83	2.48	63	1-3/8	1-3/4
4NH3-20-20	1-1/4		1-1/4	1-5/8x12	4.68	119	2.99	76	1-3/4	2
4NH3-24-24	1-1/2		1-1/2	1-7/8x12	3.92	100	3.64	92	2	2-3/8

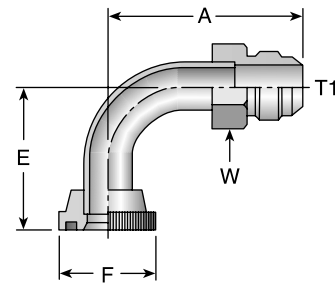

6AH3

SAE Code 62 Flange - Male SAE (JIC) 37° Flare

# Part Number	Flange		Thread T1		A		W	F
	inch				inch	mm	inch	inch
6AH3-12-12	3/4		3/4	1-1/16x12	3.82	97	1-1/8	1-5/8
6AH3-16-16	1		1	1-5/16x12	4.09	104	1-3/8	1-7/8
6AH3-20-20	1-1/4		1-1/4	1-5/8x12	4.16	106	1-3/4	2-1/8
6AH3-24-24	1-1/2		1-1/2	1-7/8x12	4.97	126	2	2-1/2

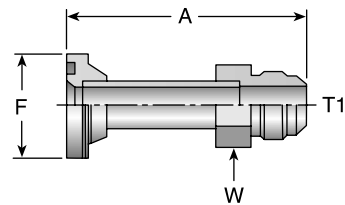

6FH3

SAE Code 62 Flange - Male SAE (JIC) 37° Flare - 45° Elbow

# Part Number	Flange		Thread T1		A		E		W	F
	inch				inch	mm	inch	mm	inch	inch
6FH3-12-12	3/4		3/4	1-1/16x12	3.40	86	1.06	27	1-1/8	1-5/8
6FH3-16-16	1		1	1-5/16x12	3.85	98	1.28	33	1-3/8	1-7/8
6FH3-20-20	1-1/4		1-1/4	1-5/8x12	4.22	107	1.36	35	1-3/4	2-1/8
6FH3-24-24	1-1/2		1-1/2	1-7/8x12	5.13	130	1.71	43	2	2-1/2

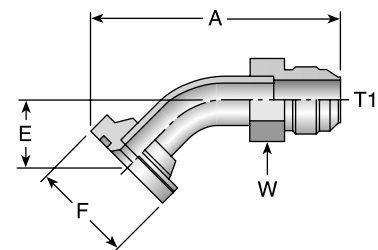

6NH3

SAE Code 62 Flange - Male SAE (JIC) 37° Flare - 90° Elbow

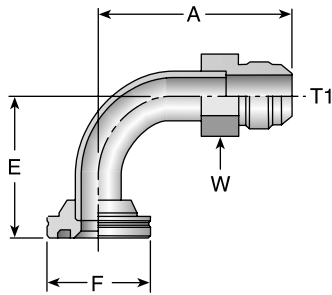

# Part Number	Flange inch	Thread T1	A		E		W inch	F inch	
			inch	mm	inch	mm			
6NH3-12-12	3/4	3/4	1-1/16x12	3.07	78	2.24	57	1-1/8	1-5/8
6NH3-16-16	1	1	1-5/16x12	3.58	91	2.81	71	1-3/8	1-7/8
6NH3-20-20	1-1/4	1-1/4	1-5/8x12	4.68	119	2.99	76	1-3/4	2-1/8
6NH3-24-24	1-1/2	1-1/2	1-7/8x12	3.92	100	3.64	92	2	2-1/2

4AJM

Code 61 Flange - Male Seal-Lok

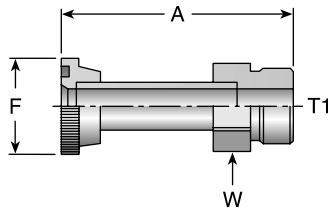

# Part Number	Flange inch	Thread T1	A		W inch	F inch
			inch	mm		
4AJM-12-12	3/4	1-3/16x12	3.65	93	1-1/4	1-1/2
4AJM-16-16	1	1-7/16x12	3.90	99	1-1/2	1-3/4
4AJM-20-20	1-1/4	1-11/16x12	3.92	100	1-3/4	2

4FJM

Code 61 Flange - Male Seal-Lok - 45° Elbow

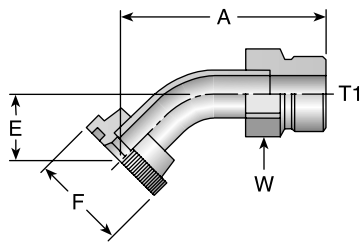

# Part Number	Flange inch	Thread T1	A		E		W inch	F inch
			inch	mm	inch	mm		
4FJM-12-12	3/4	1-3/16x12	3.22	82	1.06	27	1-1/4	1-1/2
4FJM-16-16	1	1-7/16x12	3.64	92	1.27	33	1-1/2	1-3/4
4FJM-20-20	1-1/4	1-11/16x12	3.99	101	1.36	35	1-3/4	2

4NJM

Code 61 Flange - Male Seal-Lok - 90° Elbow

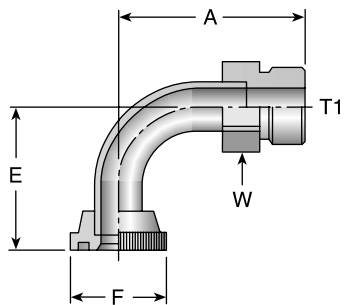

# Part Number	Flange inch	Thread T1	A		E		W inch	F inch
			inch	mm	inch	mm		
4NJM-12-12	3/4	1-3/16x12	2.90	74	2.24	57	1-1/4	1-1/2
4NJM-16-16	1	1-7/16x12	3.38	86	2.81	71	1-1/2	1-3/4
4NJM-20-20	1-1/4	1-11/16x12	4.44	113	2.99	76	1-3/4	2

6AJM

Code 62 Flange - Male Seal-Lok

# Part Number	Flange inch	Thread T1	A		W inch	F inch
			inch	mm		
6AJM-12-12	3/4	1-3/16x12	3.65	93	1-1/4	1-5/8
6AJM-16-16	1	1-7/16x12	3.90	99	1-1/2	1-7/8
6AJM-20-20	1-1/4	1-11/16x12	3.92	100	1-3/4	2-1/8

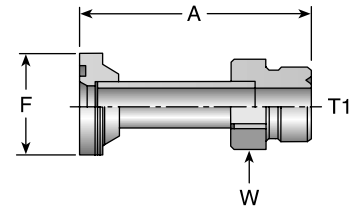

6FJM

Code 62 Flange - Male Seal-Lok - 45° Elbow

# Part Number	Flange inch	Thread T1	A		E		W inch	F inch
			inch	mm	inch	mm		
6FJM-12-12	3/4	1-3/16x12	3.22	82	1.06	27	1-1/4	1-5/8
6FJM-16-16	1	1-7/16x12	3.64	92	1.27	33	1-1/2	1-7/8
6FJM-20-20	1-1/4	1-11/16x12	3.99	101	1.36	35	1-3/4	2-1/8

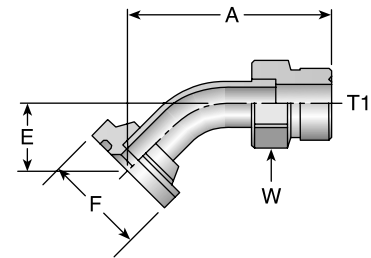

6NJM

Code 62 Flange - Male Seal-Lok - 90° Elbow

# Part Number	Flange inch	Thread T1	A		E		W inch	F inch
			in	mm	in	mm		
6NJM-12-12	3/4	1-3/16x12	2.90	74	2.24	57	1-1/4	1-5/8
6NJM-16-16	1	1-7/16x12	3.38	86	2.81	71	1-1/2	1-7/8
6NJM-20-20	1-1/4	1-11/16x12	4.44	113	2.99	76	1-3/4	2-1/8

6NJM does not include O-rings. Order separately.

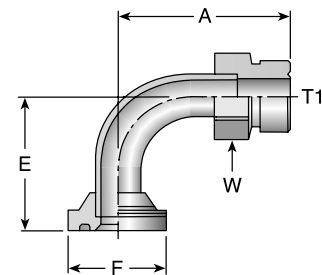

A

B

C

D

E

SAE J518 port dimensions for 4-Bolt Split Flanges

There are two non-interchangeable SAE split flanges:

- a. Standard or Code 61 is for 3,000psi to 5,000psi maximum, depending on size.
- b. High Pressure or Code 62 is for 6,000psi maximum, regardless of size. The flange head is "V" notched for identification.

Consult these tables to determine flange halves and flange kits specifications.

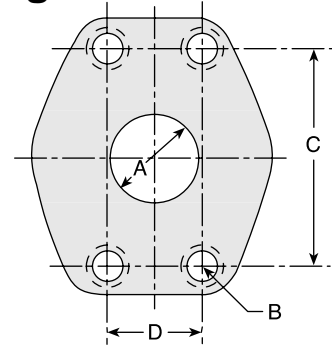

Standard Pressure (Code 61)

Nominal Flange	Flange Dash Size	A Dia Max		B Thread	C		D		Maximum Working Pressure	
		inch	mm		±0.010 inch	±0.25 mm	±0.010 inch	±0.25 mm	psi	MPa
1/2	-8	0.50	13	5/16x18	1.50	38,10	0.68	17,47	5,000	34,5
3/4	-12	0.75	19	3/8x16	1.88	47,63	0.87	22,22	5,000	34,5
1	-16	1.00	25	3/8x16	2.06	52,37	1.03	26,18	5,000	34,5
1 1/4	-20	1.25	32	7/16x14	2.31	58,72	1.18	30,17	4,000*	27,6
1 1/2	-24	1.50	38	1/2x13	2.75	69,85	1.40	35,71	3,000*	20,7
2	-32	2.00	51	1/2x13	3.06	77,77	1.68	42,87	3,000*	20,7

Note: *5000 psi with 4A, 4F and 4N Fittings and 50H Flange Halves.

High Pressure (Code 62)

Nominal Flange	Flange Dash Size	A Dia Max		B Thread	C		D		Maximum Working Pressure	
		inch	mm		±0.010 inch	±0.25 mm	±0.010 inch	±0.25 mm	psi	MPa
3/4	-12	0.75	19	3/8x16	2.00	47,75	0.88	22,35	6,000	41,4
1	-16	1.00	25	7/16x14	2.25	57,15	1.09	27,76	6,000	41,4
1-1/4	-20	1.25	32	1/2x13	2.63	66,67	1.25	31,75	6,000	41,4
1-1/2	-24	1.50	38	5/8x11	3.13	79,37	1.43	36,49	6,000	41,4
2	-32	2.00	51	3/4x10	3.81	96,82	1.75	44,45	6,000	41,4

50H

5000 psi Flange Half (Code 61)

# Part Number	SAE Flange Size inch	A inch	B inch	C inch	Maximum Working Pressure psi
50H-20	1-1/4	2.31	0.55	0.47	5,000
50H-24	1-1/2	2.75	0.66	0.53	5,000
50H-32	2	3.06	0.80	0.53	5,000

Note: For use with 4A, 4F and 4N Flanges.

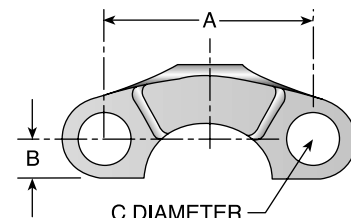

5050HK 5000 psi Flange Kit (Code 61)

# Part Number	SAE Flange Size inch	Maximum Working Pressure (psi)	(2) Flange Halves	O-Ring	(4) Bolts Grade 8		(4) Washers
					Thread inch	Length inch	
5050HK-20	1-1/4	5,000	50H-20	711510-3	7/16x14	1-1/2	7/16
5050HK-24	1-1/2	5,000	50H-24	711510-2	1/2x13	1-1/2	1/2
5050HK-32	2	5,000	50H-32	711510-1	1/2x13	1-1/2	1/2

Note: For use with 4A, 4F and 4N Flanges.

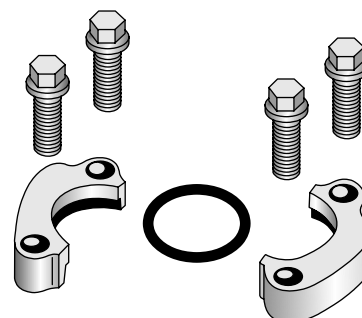

51H SAE Flange Half (Code 61)

# Part Number	SAE Flange Size inch	A inch	B inch	C inch	Maximum Working Pressure psi
51H-8	1/2	1.50	0.31	0.34	5,000
51H-12	3/4	1.88	0.40	0.41	5,000
51H-16	1	2.06	0.48	0.41	5,000
51H-20	1-1/4	2.31	0.56	0.47	4,000
51H-24	1-1/2	2.75	0.67	0.53	3,000
51H-32	2	3.06	0.81	0.53	3,000
51H-40	2-1/2	3.50	0.96	0.53	2,500

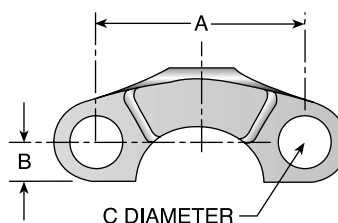

5151HK SAE Flange Kit (Code 61)

# Part Number	SAE Flange Size inch	Maximum Working Pressure (psi)	(2) Flange Halves	O-Ring	(4) Bolts Grade 8		(4) Washers
					Thread inch	Length inch	
5151HK-8	1/2	5,000	51H-8	711510-6	5/16x18	1-1/4	5/16
5151HK-12	3/4	5,000	51H-12	711510-5	3/8x16	1-1/4	3/8
5151HK-16	1	5,000	51H-16	711510-4	3/8x16	1-1/4	3/8
5151HK-20	1-1/4	4,000	51H-20	711510-3	7/16x14	1-1/2	7/16
5151HK-24	1-1/2	3,000	51H-24	711510-2	1/2x13	1-1/2	1/2
5151HK-32	2	3,000	51H-32	711510-1	1/2x13	1-1/2	1/2
5151HK-40	2-1/2	2,500	51H-40	711510-7	1/2x13	1-3/4	1/2
5151HK-48	3	2,000	51H-48	711510-8	5/8-11	1-3/4	5/8

Note: High pressure applications also require the use of Code 61 Flange End hose fittings.

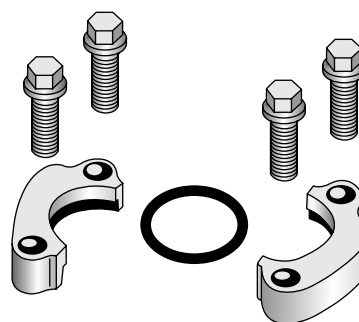

A

B

C

D

E

A

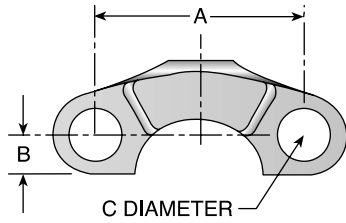

HFH

SAE Flange Half (Code 62)

# Part Number	SAE Flange Size inch	A inch	B inch	C inch	Maximum Working Pressure psi
HFH-12	3/4	2.00	0.43	0.41	6,000
HFH-16	1	2.25	0.51	0.47	6,000
HFH-20	1 1/4	2.62	0.59	0.53	6,000
HFH-24	1 1/2	3.12	0.68	0.66	6,000
HFH-32	2	3.81	0.84	0.78	6,000

B

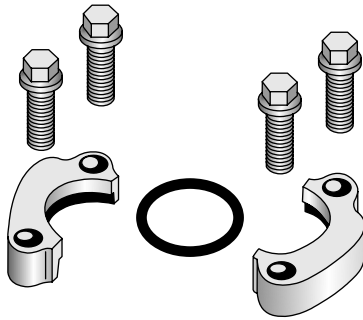

HFHFHK

SAE Flange Kit (Code 62)

# Part Number	SAE Flange Size inch	Maximum Working Pressure psi	(2) Flange Halves	O-Ring	(4) Bolts Grade 8		(4) Washers
					Thread inch	Length inch	
HFHFHK-12	3/4	6,000	HFH-12	711510-5	3/8x16	1-1/2	3/8
HFHFHK-16	1	6,000	HFH-16	711510-4	7/16x14	1-3/4	7/16
HFHFHK-20	1-1/4	6,000	HFH-20	711510-3	1/2x13	1-3/4	1/2
HFHFHK-24	1-1/2	6,000	HFH-24	711510-2	5/8x11	2-1/4	5/8
HFHFHK-32	2	6,000	HFH-32	711510-1	3/4x10	2-3/4	3/4

C

D

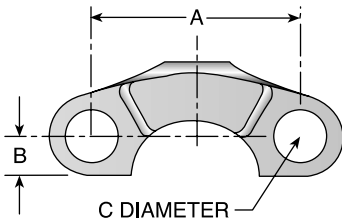

8FH

Flange Half (8000 psi)

# Part Number	SAE Flange Size inch	A inch	B inch	C inch	Maximum Working Pressure psi
8FH-12	3/4	2.00	0.43	0.41	8,000
8FH-16	1	2.25	0.51	0.47	8,000

E

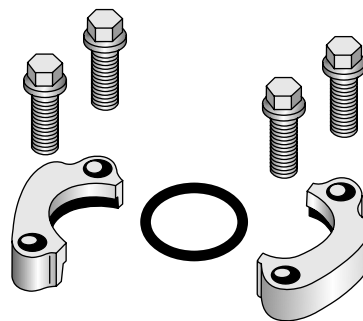

8FHFK

Flange Kit (8000 psi)

# Part Number	SAE Flange Size inch	Maximum Working Pressure psi	(2) Flange Halves	D-Ring	(4) Bolts Grade 8		(4) Washers
					Thread inch	Length inch	
8FHFK-12	3/4	8,000	8FH-12	8ARG-12	3/8-16	1-3/4	3/8
8FHFK-16	1	8,000	8FH-16	8ARG-16	7/16-14	1-3/4	7/16

Full Flange System

SAE J1518 Code 61 or Code 62

Parker's Hose Products Division introduces a one-piece flange option for Code 61 and Code 62 connections. The patent-pending design enables the flange to be attached to the hose after the hose fitting has been crimped to the hose. Once the fitting is crimped, an SAE J1518 Code 61 or a Code 62 full flange can be attached using the high tensile stainless steel retaining ring. The versatile fitting design enables greater flexibility by reducing the number of potential hose fittings in your inventory.



Product Features

- One-piece full flange connection
- The full flange system is designed to work with all Parkrimp crimpers
- Fittings are compatible for both Code 61 and Code 62 flanges
- All Code 61 sizes rated to 5000 psi

Flange Kits:

Code 61 Flange Kit - All sizes rated for 5000 psi

Part Number	SAE Flange Size inch	Maximum Working Pressure psi	Flange	Seal	Retaining Ring	(4) Bolts Grade 8	
						Thread inch	Length inch
FFK61-12	3/4	5,000	R312-35-CFX	XRG-12	R12X	UNC 3/8 - 16	1-1/2
FFK61-16	1	5,000	R316-CFX	XRG-16	R16X	UNC 3/8 - 16	1-1/2
FFK61-20	1 1/4	5,000	R320-12.5-CFX	XRG-20	R20X	UNC 7/16 - 14	1-1/2
FFK61-24	1 1/2	5,000	R324-CFX	XRG-24	R24X	UNC 1/2 - 13	1-3/4
FFK61-32	2	5,000	R332-CFX	XRG-32	R32X	UNC 1/2 - 13	1-3/4

Code 62 Flange Kit

Part Number	SAE Flange Size inch	Maximum Working Pressure psi	Flange	Seal	Retaining Ring	(4) Bolts Grade 8	
						Thread inch	Length inch
FFK62-12	3/4	6,000	R612-35-CFX	XRG-12	R12X	UNC 3/8 - 16	1-1/2
FFK62-16	1	6,000	R616-CFX	XRG-16	R16X	UNC 7/16 - 14	1-1/2
FFK62-20	1 1/4	6,000	R620-CFX	XRG-20	R20X	UNC 1/2 - 13	1-3/4
FFK62-24	1 1/2	6,000	R624-CFX	XRG-24	R24X	UNC 5/8 - 11	2-1/4
FFK62-32	2	6,000	R632-CFX	XRG-32	R32X	UNC 3/4 - 10	2-3/4

Kit Part Number	Retaining Ring	O-ring
RK-12	R12X	XRG-12
RK-16	R16X	XRG-16
RK-20	R20X	XRG-20
RK-24	R24X	XRG-24
RK-32	R32X	XRG-32

The stainless steel retaining rings and O-rings are recommended for one-time use. Order additional ring kits using the part numbers shown.

DIN and ISO Metric Ports

DIN (German) and ISO (International Organization for Standardization) flange heads are the same as SAE flange heads. By comparison, the ports have the same configuration except that the DIN and ISO Type I ports accept metric bolts. This requires special flange halves in most sizes.

SAE J518	DIN 20078	ISO 6162 Type I
Code 61	Form R	3,5 to 35 MPa Series
Code 62	Form S	35 to 40 MPa Series

M1H DIN (ISO) Flange Half

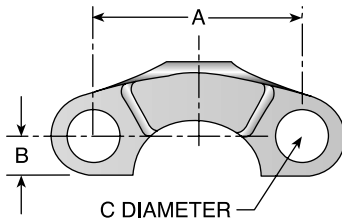

# Part Number	DIN Flange Size	ISO Flange Size	A mm	B mm	C mm	Maximum Working Pressure	
						psi	MPa
M1H-8	8	13	38	8	9	5,000	34,5
M1H-12	12	19	48	10	11	5,000	34,5
M1H-16	16	25	52	12	11	5,000	34,5
M1H-20	20	32	59	14	11	4,000	27,6
M1H-24	24	38	70	17	13.5	3,000	20,7
M1H-32	32	51	78	21	13.5	3,000	20,7

Note: High pressure applications also require the use of Code 62 Flange End hose fittings.

M1M1HK DIN (ISO) Flange Kit (Code 61)

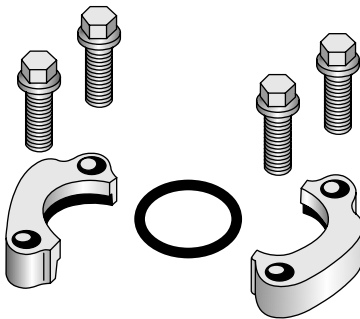

# Part Number	DIN Flange Size	ISO Flange Size	Maximum Working Pressure		(2) Flange Halves	O-Ring	(4) Bolts		(4) Washers
			psi	MPa			Thread mm	Length mm	
M1M1HK-8	8	13	5,000	34,5	M1H-8	711510-6	M8x1.25	30	10
M1M1HK-12	12	19	5,000	34,5	M1H-12	711510-5	M10x1.50	30	10
M1M1HK-16	16	25	5,000	34,5	M1H-16	711510-4	M10x1.50	30	10
M1M1HK-20	20	32	4,000	27,6	M1H-20	711510-3	M10x1.50	40	10
M1M1HK-24	24	38	3,000	20,7	M1H-24	711510-2	M12x1.75	40	12
M1M1HK-32	32	51	3,000	20,7	M1H-32	711510-1	M12x1.75	40	12
M1M1HK-40	40	64	2,500	17,2	M1H-40	711510-7	M12x1.75	45	12

M2H

DIN (ISO) Flange Half (Code 62)

# Part Number	DIN Flange Size	ISO Flange Size	A mm	B mm	C mm	Maximum Working Pressure	
						psi	MPa
M2H-8	8	13	41	8	9	6,000	41,5
M2H-12	12	19	51	11	11	6,000	41,5
M2H-16	16	25	57	13	13,5	6,000	41,5
M2H-20	20	32	67	15	15	6,000	41,5
M2H-24	24	38	79	17	17,5	6,000	41,5
M2H-32	32	51	97	21	22	6,000	41,5

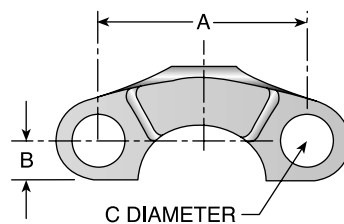

M2M2HK

DIN (ISO) Flange Kit (Code 62)

# Part Number	DIN Flange Size	ISO Flange Size	Maximum Working Pressure		(2) Flange Halves	O-Ring	(4) HHCS		(4) Washers
			psi	MPa			Thread mm	Length mm	
M2M2HK-8	8	13	6,000	41,5	M2H-8	711510-6	M8x1.25	30	8
M2M2HK-12	12	19	6,000	41,5	M2H-12	711510-5	M10x1.50	35	10
M2M2HK-16	16	25	6,000	41,5	M2H-16	711510-4	M12x1.75	45	12
M2M2HK-20	20	32	6,000	41,5	M2H-20	711510-3	M12x1.75	45	12
M2M2HK-24	24	38	6,000	41,5	M2H-24	711510-2	M16x2.00	55	16
M2M2HK-32	32	51	6,000	41,5	M2H-32	711510-1	M20x2.50	70	20

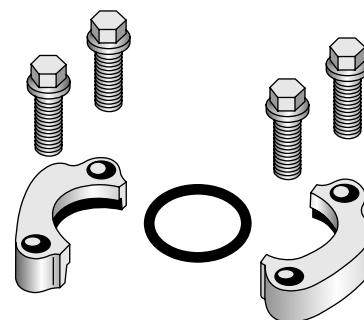

XCXCHK

Caterpillar® Flange Kits

# Part Number	C inch	Maximum Working Pressure psi	(4) Bolts Grade 8			(4) Washers
			O-Ring	Thread mm	Length mm	
XCXCHK-12	0.406	6,000	8ARG-12	3/8-16	1.75	3/8
XCXCHK-16	0.469	6,000	8ARG-16	7/16-14	1.75	7/16
XCXCHK-20	0.531	6,000	8ARG-20	1/2-13	2.00	1/2
XCXCHK-24	0.656	6,000	8ARG-24	5/8-11	2.50	5/8
XCXCHK-32	0.827	6,000	8ARG-32	3/4-10	2.75	3/4

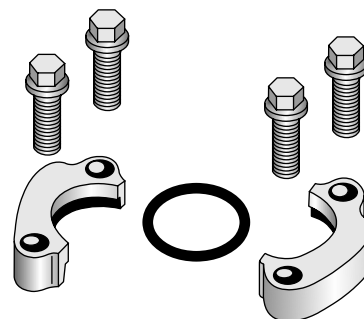

A

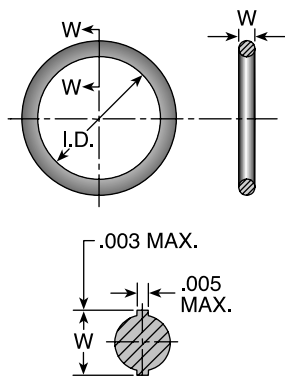

711509

O-Rings - SAE Thread (Compound N552-90)*

# Part Number	Tube Dash Size	Tube O.D. inch	SAE Thread inch	W		I.D.	
				inch	mm	inch	mm
711509-1	-4	1/4	7/16x20	0.072	1,83	0.351	8,92
711509-2	-5	5/16	1/2x20	0.072	1,83	0.414	10,52
711509-3	-6	3/8	9/16x20	0.078	1,98	0.468	11,89
711509-4	-8	1/2	3/4x16	0.087	2,21	0.644	16,36
711509-5	-10	5/8	7/8x14	0.097	2,46	0.755	19,18
711509-6	-12	3/4	1-1/16x12	0.116	2,95	0.924	23,53
711509-7	-16	1	1-5/16x12	0.116	2,95	1.171	29,74
711509-8	-20	1-1/4	1-5/8x12	0.118	3,00	1.475	37,47
711509-9	-24	1-1/2	1-7/8x12	0.118	3,00	1.720	43,69
711509-10	-32	2	2-1/2x12	0.118	3,00	2.337	59,36

B

711510

O-Rings - Code 61 and Code 62 Flanges (Compound N552-90)*

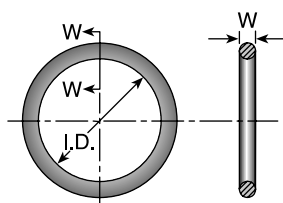

# Part Number	Flange Dash Size	Flange Size inch	W		I.D.	
			inch	mm	inch	mm
711510-6	-8	1/2	0.14	3,53	0.73	18,64
711510-9*	-10	5/8	0.14	3,53	0.79	20,20
711510-5	-12	3/4	0.14	3,53	0.98	25,00
711510-4	-16	1	0.14	3,53	1.29	32,92
711510-3	-20	1-1/4	0.14	3,53	1.48	37,69
711510-2	-24	1-1/2	0.14	3,53	1.85	47,22
711510-1	-32	2	0.14	3,53	2.23	56,74
711510-7	-40	2-1/2	0.14	3,53	2.73	69,44
711510-8	-48	3	0.14	3,53	3.35	85,32

*Note: For use with petroleum base fluids, other compounds available for Phosphate Ester fluids. Please contact The Parker Hannifin Seal Group/O-Ring Division (1-800-C-PARKER) for additional information.

C

D

C9RG

O-Rings for CA, CE, CF Metric

# Part Number	W mm	I.D. mm
C9RG-8	1,5	6,0
C9RG-10	1,5	7,5
C9RG-12	1,5	9,0
CARG-15	2,0	12,0
CARG-18	2,0	15,0
CARG-22	2,0	20,0
CARG-28	2,0	26,0

C9RG

O-Rings for C9, OC, 1C Metric Swivels

# Part Number	W mm	I.D. mm
C9RG-8	1,5	6,0
C9RG-10	1,5	7,5
C9RG-12	1,5	9,0
C9RG-14	2,0	10,0
C9RG-20	2,4	16,3
C9RG-25	2,4	20,3
C9RG-30	2,4	25,3
C9RG-38	2,5	33,0

D9DT

Bonded Seal for BSPP Port Fittings

# Part Number	I.D.		O.D.	
	Inch	mm	Inch	mm
D9DT-4	0.54	13,7	0.81	20,6
D9DT-6	0.68	17,3	0.94	23,9
D9DT-8	0.85	21,6	1.13	28,7
D9DT-10	0.93	23,6	1.25	31,8
D9DT-12	1.06	27,0	1.38	35,1
D9DT-16	1.33	33,8	1.68	42,7

*Note: D9DT must be ordered from the Tube Fittings Division. Please contact TFD for additional size and product information.

E

J0RG

O-Rings - Seal-Lok®

Part Number	Tube Dash Size	Tube O.D. Inch	SAE Thread Inch	I.D.		O.D.	
				Inch	mm	Inch	mm
J0RG-4	-4	1/4	9/16x18	0.301	7,65	0.070	1,78
J0RG-6	-6	3/8	11/16x16	0.364	9,25	0.070	1,78
J0RG-8	-8	1/2	13/16x16	0.489	12,42	0.070	1,78
J0RG-10	-10	5/8	1x14	0.614	15,59	0.070	1,78
J0RG-12	-12	3/4	1-3/16x12	0.739	18,77	0.070	1,78
J0RG-16	-16	1	1-7/16x12	0.926	23,52	0.070	1,78
J0RG-20	-20	1-1/4	1-11/16x12	1.176	29,87	0.070	1,78
J0RG-24	-24	1-1/2	2x12	1.489	37,82	0.070	1,78

Note: O-Rings for use in Seal-Lok® connections are illustrated in actual size. Part numbers for O-Rings used in Seal-Lok® and in SAE port connections are also listed in the table. O-Rings are supplied in Nitrile NBR compound, 90 durometer hardness.

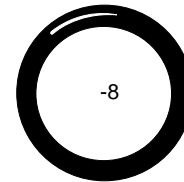

SAE 711509-4

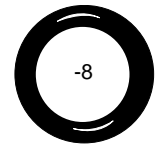

Seal-Lok J0RG-8

Photo shows an actual comparison between an SAE port O-Ring (top) and a Seal-Lok® O-Ring (bottom). They differ in both diameter and cross section.

XARG

Flange "D" Rings Caterpillar® Style Flanges

Part Number	Flange Size	Dash Size	I.D.		O.D.	
			Inch	mm	Inch	mm
XARG-12	3/4	-12	0.20	5,0	1.00	25,4
XARG-16	1	-16	0.20	5,0	1.25	31,8
XARG-20	1-1/4	-20	0.20	5,0	1.50	38,1
XARG-24	1-1/2	-24	0.20	5,0	1.75	44,5
XARG-32	2	-32	0.20	5,0	2.52	63,9

8ARG

Flange "D" Rings for 76 Series Style Flange

Part Number	Flange Size	Dash Size	Seal Thickness		Seal I.D.	
			Inch	mm	Inch	mm
8ARG-12	3/4	-12	0.20	5,0	1.00	25,4
8ARG-16	1	-16	0.20	5,0	1.25	31,9

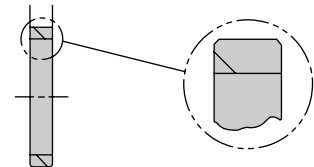

A

B

C

D

E

59RG

O-Rings for Tube O-Ring Fittings and Compressor Fittings

Part Number	Tube O.D. Inch	Tube Dash Size	Parker Seal Number
59RG-6	3/8	-6	2-011
59RG-8	1/2	-8	2-013
59RG-10	5/8	-10	2-015
59RG-12	3/4	-12	2-017

Note: The above O-Rings (RG) have HNBR compound number N1195-70 (green).

T1RG

O-Rings for Compression Fittings (1T126)

Part Number	Tube O.D. Inch	Tube Dash Size	Parker Seal Number
T1RG-6	3/8	-6	2-012
T1RG-8	1/2	-8	2-014
T1RG-10	5/8	-10	2-016
T1RG-12	3/4	-12	2-018

Charge Ports Caps R134a

Part Number	Fitting Size	Fitting Shape	Port Type	
			Flow	Side
940199	-6 & -8	Straight	High	High
940200	-10 & -12	Straight	High	Low
940188	-6 & -8	Elbows	Standard	High
940189	-10 & -12	Elbows	Standard	Low

R12

Part Number	Thread
940249	7/16x20

CORG

Captive O-Ring Assembly Tools

Parker's new CORG Assembly Tools are designed to facilitate the installation of the O-Ring into the half-dovetail groove of the O-Ring face seal fitting.

Fitting Size	Hand Type Part Number	Bench Type Part Number
-4	CORG-4	CORG-AT04 Bench
-6	CORG-6	CORG-AT06 Bench
-8	CORG-8	CORG-AT08 Bench
-10	CORG-10	CORG-AT10 Bench
-12	CORG-12	CORG-AT12 Bench
-16	CORG-16	CORG-AT16 Bench
-20	CORG-20	CORG-AT20 Bench
-24	CORG-24	CORG-AT24 Bench
-32	CORG-32	



Bench Type



Hand Type

Note: CORG Assembly Tools must be ordered from the Tube Fittings Division (614) 279-7070.

Note: O-Rings listed are for use with petroleum base fluids. Other compounds are available for Phosphate Ester fluids by special order. For Viton® or other O-Ring compounds, consult Parker Hannifin, Seal/O-Rings Products Division (1-800-C-PARKER.)

Partek Wrap

The need for a protective hose sleeve is not always considered while designing for a hose's application. Many hose assembly installations would benefit from a sleeve, but it is not obvious until all the other hoses and components are in place. Parker's Partek Wrap enables the hose sleeve to be installed after the hose assemblies have been positioned and secured in place. The Partek Wrap can be used as extra abrasion protection or to wrap multiple hoses or cables together.

Product Features

- Post assembly installation
- Light weight and highly flexible
- Urethane-coated 1050 Ballistic Nylon
- Ambient temperature range of -60°F to +200°F
- Fast and easy installation
- MSHA Certified for use in underground mines



Partek Wrap

Part Number	Bundle O.D.	Circumference inch	Open Width (+/- 0.375) inch	Roll Length feet	Color
PS-BV-300	3	9.40	10.90	50	Black
PS-BV-400	4	12.50	14.00	50	Black
PS-BV-500	5	15.75	17.25	50	Black
PS-BV-700	7	22.00	23.50	50	Black

Other sizes available upon request with minimum order.



A

B

C

D

E

Accessory Selection Guide – Partek Sleeve (AS-B, AS-Y or PS)

Parker's Partek Nylon Protective Sleevings gives you tough hose abrasion protection two ways. First, per the ISO 6945 specification, Partek has a unique tubular weave nylon construction, Partek "AS" is strong enough to withstand greater than 200,000 abrasion cycles without wearing through the fabric at any location. Partek "PS" can withstand greater than 50,000 abrasion cycles. In addition, this weave also gives an exceptionally smooth interior wall, allowing rubber hose to move freely inside the sleeve. This provides easy installation and prevents any internal abrasion problems. Partek sleeving is available in either black or yellow and in sizes to fit most hydraulic hose. Partek, the quick and easy solution to hose protection in high-abrasion areas.

Temperature Range: -67°F to +248°F (-53°C to +120°C)

- MSHA Certified for use in underground mines

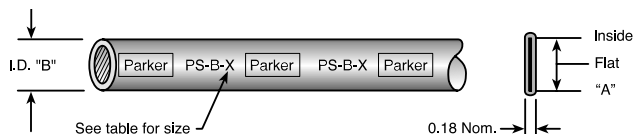

Note: The inside flat "A" dimension corresponds with the inside diameter "B" dimension. For example, AS-Y-13 flat surface "A" is 1.34 in. This offers a .86 in. inside diameter "B". Hose with a smaller O.D. can be specified for this size sleeve. Parker 201-5 hose has a .58 in. O.D. and can easily be inserted in the Partek AS-Y-13 Sleeve.



Partek Sleeve



Partek "PS" Sleeve

Partek Sleeve Application - Hose Type/Size

Partek Sleeve Black Part Number	Partek Sleeve Yellow Part Number	Partek PS Sleeve Black Part Number	Inside Diameter		SS25UL 201, 206 221FR 225, 235 244 266 293	213 271 285 421WC	BXX 302 301LT 304 381 472TC	AX, MX 351TC, 351ST 422, 424 426, 431 451ST, 471TC 471ST, 472LT, 472TC 482TC, 482ST 273	601 604 636 646	701, 711 721, 721TC 721ST, 722LT 722LT, 722TC 772TC 772ST, 774 787TC, 797TC	731, 781 782TC 782ST 791TC 792LT 792TC 831 811HT 881	801 804 821 821FR 836	811 811HT 881	275	761	Twin Line
			A	B												
AS-B-11	AS-Y-11		1.07	0.69	-4	-4		-3,-4								
AS-B-13	AS-Y-13	PS-B-13	1.34	0.86	-5,-6	-5,-6	-4,-5	-5,-6	-4	-4,-5			-5,-6			
AS-B-15	AS-Y-15	PS-B-15	1.66	1.06	-8	-8,-10	-6	-8	-6	-6			-8			
AS-B-17	AS-Y-17	PS-B-17	1.92	1.22	-10	-12	-8,-10	-10	-8	-8			-10			
AS-B-19	AS-Y-19		2.12	1.35	-12			-12	-10	-10			-12	-10		
AS-B-22	AS-Y-22	PS-B-22	2.24	1.42	-16	-16	-12		-12	-12			-16	-12	-16	
AS-B-27	AS-Y-27		2.55	1.63				-16							-12	6-6,8-8
AS-B-33	AS-Y-33	PS-B-33	2.85	1.81	-20	-20	-16		-16	-16			-16		-16	8-8
	AS-Y-35	PS-B-35	3.43	2.19	-24	-24		-20					-20	-20	-20	
AS-B-37	AS-Y-37	PS-B-37	3.73	2.38			-20	-24		-20			-20	-24		
		PS-B-39	4.12	2.63	-32	-32	-24			-24			-24			
		PS-B-45	4.53	2.88			-32	-32					-32			
		PS-B-47	4.90	3.13	-40	-40				-32						
AS-B-58			5.69	3.63	-48	-48							-48			
AS-B-64			6.18	4.00												

- Note:**
1. The dimensions shown are related to the hose outside diameter and may not fit over the fitting. For over the fitting applications, a larger size sleeve may be required.
 2. Cut lengths are available. Contact your local distributor for prices (www.parkerhose.com).

Accessory Selection Guide – PolyGuard (HG)

- Shield hose from abrasion and cuts
- Minimize kinking
- Cannot rust or corrode

Heavy-duty polyethylene provides protection in rugged operating conditions. Great for bundling high-pressure hose lines.

Cut edges can be smoothed by applying heat.

CAUTION: This material will support combustion.

Color: Black

Temperature Range: 0°F to +200°F (-17°C to +93°C)

Lower-cost protection for applications that call for a tighter bend radius and are less demanding.

Cut edges can be smoothed by applying heat.

CAUTION: This material will support combustion.

Color: Black

Temperature Range: 0°F to +200°F (-17°C to +93°C)

- Resist water, oil, gasoline, hydraulic fluid, and most solvents
- Ideal for bundling plastic tubing or hose lines
- Easy to install without removing hose lines; no clamps needed



PolyGuard



ParKoil™

PolyGuard (HG), ParKoil (PG) Application - Hose Type/Size

Poly Guard Part Number	ParKoil Part Number	Inside Dia.	SS25UL		BXX	AX, MX		601	701, 711		731, 781	801	811	821FR	811HT	836	881	275	761	Twin Line	
			201, 206	213		351TC, 351ST	426, 431		721, 721TC	782TC											
HG-075		0.75	-8,-10	-8,-10	-6,-8	-8,-10	-6,-8	-6,-8	-4,-6		-8,-10	-10	-10	-10							
HG-100		1.00	-12	-12	-10,-12	-12	-10	-10	-8,-10		-12	-12	-12	-10							
HG-125		1.25	-16	-16		-16	-12	-12	-12		-16	-16	-16	-12							
HG-150		1.50	-20,-24	-20,-24	-16,-20	-20	-16,-20	-16	-16,-20		-16,-20	-20	-20	-16,-20							
HG-200		2.00	-32,-40	-32,-40	-24,-32	-24,-32			-20,-24,-32		-24,-32	-24	-24	-24,-32,-40							
HG-350		3.50	-48	-48										-48							
	PG-038	0.38		-4		-3															
	PG-050	0.50	-4,-5	-5	-3,-4	-4,-5	-4	-4				-4									
	PG-062	0.62	-6	-6,-8	-5	-6						-6									
	PG-075	0.75	-8	-10	-6	-8	-6	-6	-6			-8									
	PG-088	0.88	-10	-12	-8	-10	-8	-8	-8			-10									
	PG-100	1.00	-12	-10,-12	-10,-12	-12	-10	-10	-10			-12									-10
	PG-119	1.19	-16	-16		-12	-12	-12	-12			-16		-12							-10
	PG-138	1.38	-20,-24	-20,-24	-16	-16,-20	-16	-16	-16,-20			-16,-20		-16,-20							6-6,6-8
	PG-188	1.88	-32,-40,-48	-32,-40,-48	-20,-24,-32	-24,-32			-24,-32			-24,-32		-24,-32							8-8



Accessory Selection Guide – Spring Guard and Armor Guard

Parker Spring Guard and Armor Guard are two products that prolong the life of hose lines that are exposed to rugged operating conditions. They distribute bending radii to avoid kinking in hose lines and protect hose from abrasion and deep cuts. Guards are constructed of steel wire and plated to resist rust.



Spring Guard (SG)



Armor Guard (AG)

Spring Guard/Armor Guard Application - Hose Type/Size

Spring Guard Part Number	Armor Guard Part Number	Inside Dia.	SS25UL 201, 206 221FR 225, 235 244 266	213 271 285 293	BXX 302 301LT 304 381 421WC	AX, MX 351TC, 351ST 422, 424 426, 431 436, 451TC 451ST, 471TC 471ST, 472LT, 472TC 482TC, 482ST 273	601 604 636 646	701, 711 721, 721TC 721ST, 722LT 722TC 772TC, 772ST 774 787TC, 797TC	731, 781 782TC 782ST 791TC 792LT 792TC 792ST F42, P35	801 804 821 821FR 831 836	811 811HT 881	275	761	Twin Line	
SG-050	AG-050	0.50		-4		-3									
SG-060	AG-060	0.60	-4	-5	-3	-4		-3,-4			-4,-5				
SG-066	AG-066	0.66	-5	-6	-4	-5	-4								
SG-072	AG-072	0.72	-6		-5	-6		-5			-6				
SG-084	AG-084	0.84	-8	-8	-6	-8	-6	-6	-4,-6	-4	-8				
SG-097	AG-097	0.97	-10	-10	-8	-10	-8	-8	-8	-6	-10		-10		
SG-106	AG-106	1.06		-12	-10		-10			-8					
SG-113	AG-113	1.13	-12			-12		-10	-10		-12				
SG-122	AG-122	1.22			-12					-10			-12	-10	
SG-131	AG-131	1.31	-16	-16				-12	-12	-12	-16	-12			
SG-155	AG-155	1.55	-20	-20	-16	-16		-16	-16		-16	-16	-16	-12	6-6,8-8
SG-161		1.61								-16					
SG-166		1.66											-20		
SG-182	AG-182	1.82	-24	-24		-20		-20	-20*			-20		-16	8-8
SG-209	AG-209	2.09			-20	-24			-20	-20			-24		
SG-232	AG-232	2.32	-32		-24					-24				-20	
SG-292	AG-292	2.92										-40			

*SG-182 for size -20 hose is only for 787TC and 797TC.

Note: Spring Guard and Armor Guard are packaged in 10 ft. pieces.

Polyguard Strain Reliever

Temperature Range: -40°F to +225°F

Material: Flexible PVD

Color: Black (check for availability of other colors)

Part Number	Length inches	Hose O.D. inches
4PG	7	0.53
6PG	7	0.63
7PG	7	0.69
8PG	7	0.84



Accessory Selection Guide – Firesleeve (FS-F)

Parker Firesleeve is a flame resistant sheath that protects the hose from extreme temperature conditions. Firesleeve easily slides over hoses and readily expands over fitting. It can be assembled with Parker FSC or properly sized wormgear clamp.

Construction: Braided fiberglass sleeve and an orange, bonded and seamless silicone rubber cover.

Specifications: Conforms to SAE Aerospace Standard 1072A Type 2A.

Temperature Range: -54°C to +260°C (-65°F to +500°F).

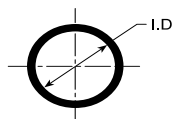

Note: The Firesleeve inside dimension (I.D.) must exceed the outside diameter (O.D.) of the hose and offer an allowance for easy hose insertion. For example, 201-16 has a 1.23 in. O.D. FS-S-24, with an I.D. of 1.46 in., is the suggested Firesleeve.

Note: Parker FSC Clamp fits all hoses up to 2 in. O.D.

Note: Parker HC Clamps (wormgear) are listed on page D-26.



Firesleeve (FS-F)



FSC Clamp

Part Number: FSC
(One size fits all hoses up to 2 inch O.D.)

Proudly offering the following certifications and specifications

- UL 1441 Certified
- VW1 Flame Test Certified
- MSHA Certified for use in underground mines
- SAE AS1072E
- GL - Germanischer Lloyd Certified for 800°C for 30 minutes
- BS EN 373 Molten Splash Tested
- BS EN 388 Abrasion Tested
- BS EN ISO 6940 Flame Resistance Tested
- BS EN ISO 6530 Oil Resistance Tested
- BS 2576 Tensile Strength Tested
- DIN 54837 / 5510-2 Rail Vehicle Certified for Resistance to Combustibility
- DIN 5659-2 /5510-2 Rail Vehicle Certified for Toxicity
- ASTM C177 Thermal Conductivity

“FS - F” Application - Hose Type/Size

Part Number	Inside Dia.	SS25UL		BXX	AX, MX		601	701, 711		731, 781		801	811	275	761	Twin Line
		201, 206	213		302	351TC, 351ST		721, 721TC	782TC	804						
FS-F-10	0.58	-4	-4	-3	-3,-4	-3										
FS-F-11	0.65	-5	-5	-4	-5	-4										
FS-F-12	0.71		-6	-5								-6				
FS-F-14	0.84	-6,-8	-8	-6	-6	-6	-5,-6					-8	-6			
FS-F-16	0.96		-10	-8	-8	-8		-6	-4							
FS-F-18	1.08	-10	-12	-8,-10	-10	-8		-8				-10	-8			
FS-F-20	1.21	-12		-12	-12	-10	-10	-10	-8			-12	-10	-10		
FS-F-22	1.34							-12								
FS-F-24	1.46	-16	-16		-16					-12	-16	-12	-12	-10	6-6,6-8	
FS-F-30	1.84	-24	-24					-16	-16			-16	-20	-16	8-8	
FS-F-38	2.34	-32	-32	-20,-24	-24			-20,-24	-20			-24	-24	-20		
FS-F-40	2.46									-24						

Note: See Page D-24 for Firesleeve assembly instructions.



Accessory Selection Guide – Firesleeve (cont.)

A

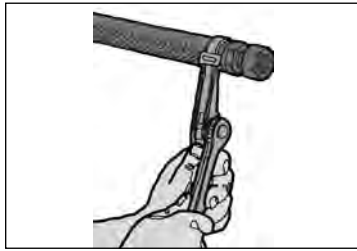

FSC Clamp

Used to attach firesleeve around socket on hose sizes with a 2" maximum O.D.



FST Clamp Tool

Part Number: FST-711617 Used to secure FSC clamp.



FSS Firesleeve Sealant

Keeps end of firesleeve from fraying - for neater, longer lasting installation.

B

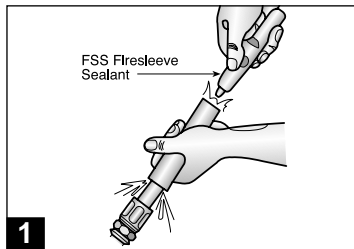

1

C

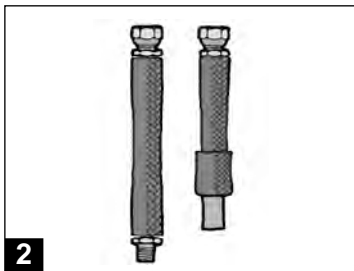

2

D



3

E



4

Firesleeve Assembly Instructions

1. Assemble one end fitting on hose. Cut firesleeve to same length as hose. Cover approximately 1" of each end of firesleeve with FSS sealant and allow to dry.
2. Push firesleeve back from cut end of hose and assemble the second end fitting. Then pull firesleeve completely over both sockets.
3. Insert tail of FSC clamp into FST clamping tool.
4. Position clamp around middle of socket and tighten with tool. Bend end of band back over buckle. Repeat on other end. Repair any scuffs or abrasions in firesleeve with FSS sealant.

Accessory Selection Guide – CL Clamp

Vinyl coated steel clamps provide hose support where long lengths are used. Provides neater installation of hose lines, minimizes hose chafing and prevents damage to hose.

Material: CR Steel with Zinc Plating

Coating: Black Vinyl Plastisol - 0,8 mm (0.03 inch) thick.

Temperature Range: -40°C to +107°C (-40°F to +225°F).

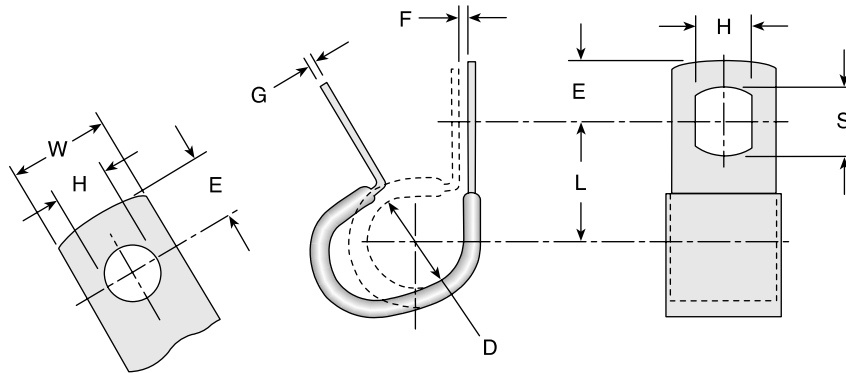

Part Number	D		H		L		W		E		F		G		S	
	±0,8 (mm)	±0.031 (inch)	±0,1 (mm)	±0.005 (inch)	±0,8 (mm)	±0.031 (inch)	±0,25 (mm)	±0.01 (inch)	±0,4 (mm)	±0.015 (inch)	±0,8 (mm)	±0.031 (inch)	±0,1 (mm)	±0.004 (inch)	±0,5 (mm)	±0.020 (inch)
CL-6	7,90	0.312	10,30	0.406	17,45	0.687	19,05	0.750	11,10	0.437	0,80	0.031	0,80	0.032	12,70	0.500
CL-7	9,50	0.375	10,30	0.406	18,25	0.718	19,05	0.750	11,10	0.437	1,55	0.062	0,80	0.032	12,70	0.500
CL-8+	11,10	0.437	10,30	0.406	19,05	0.750	19,05	0.750	11,10	0.437	1,55	0.062	1,20	0.048	12,70	0.500
CL-9	12,70	0.500	10,30	0.406	19,85	0.781	19,05	0.750	11,10	0.437	1,55	0.062	1,20	0.048	12,70	0.500
CL-10+	14,25	0.562	10,30	0.406	20,60	0.812	19,05	0.750	11,10	0.437	1,55	0.062	1,20	0.048	12,70	0.500
CL-11	15,90	0.625	10,30	0.406	21,40	0.843	19,05	0.750	11,10	0.437	1,55	0.062	1,20	0.048	12,70	0.500
CL-12	17,45	0.687	10,30	0.406	22,20	0.875	19,05	0.750	11,10	0.437	1,55	0.062	1,20	0.048	12,70	0.500
CL-13	19,05	0.750	10,30	0.406	23,00	0.906	19,05	0.750	11,10	0.437	1,55	0.062	1,20	0.048	12,70	0.500
CL-14	20,60	0.812	10,30	0.406	23,80	0.937	19,05	0.750	11,10	0.437	1,55	0.062	1,20	0.048	12,70	0.500
CL-15+	22,20	0.875	10,30	0.406	24,60	0.968	19,05	0.750	11,10	0.437	1,55	0.062	1,20	0.048	12,70	0.500
CL-16	23,80	0.937	10,30	0.406	25,40	1.000	19,05	0.750	11,10	0.437	1,55	0.062	1,20	0.048	12,70	0.500
CL-17	25,40	1.000	10,30	0.406	26,20	1.031	19,05	0.750	11,10	0.437	1,55	0.062	1,20	0.048	12,70	0.500
CL-18+	26,95	1.062	10,30	0.406	26,95	1.062	19,05	0.750	11,10	0.437	1,55	0.062	1,20	0.048	12,70	0.500
CL-19	28,60	1.125	10,30	0.406	27,75	1.093	19,05	0.750	11,10	0.437	1,55	0.062	1,20	0.048	12,70	0.500
CL-20+	30,20	1.188	13,50	0.531	31,75	1.250	25,40	1.000	14,25	0.562	1,55	0.062	1,20	0.048	15,90	0.625
CL-21	31,75	1.250	13,50	0.531	32,55	1.281	25,40	1.000	14,25	0.562	1,55	0.062	1,20	0.048	15,90	0.625
CL-22+	33,30	1.312	13,50	0.531	33,30	1.312	25,40	1.000	14,25	0.562	1,55	0.062	1,20	0.048	15,90	0.625
CL-23	34,90	1.375	13,50	0.531	34,10	1.343	25,40	1.000	14,25	0.562	1,55	0.062	1,20	0.048	15,90	0.625
CL-24+	36,50	1.437	13,50	0.531	34,90	1.375	25,40	1.000	14,25	0.562	1,55	0.062	1,20	0.048	15,90	0.625
CL-25	38,10	1.500	13,50	0.531	35,70	1.406	25,40	1.000	14,25	0.562	1,55	0.062	1,20	0.048	15,90	0.625
CL-26+	39,65	1.562	13,50	0.531	36,50	1.437	25,40	1.000	14,25	0.562	1,55	0.062	1,20	0.048	15,90	0.625
CL-27+	41,25	1.625	13,50	0.531	37,30	1.468	25,40	1.000	14,25	0.562	1,55	0.062	1,20	0.048	15,90	0.625
CL-29	44,45	1.750	13,50	0.531	38,90	1.531	25,40	1.000	14,25	0.562	1,55	0.062	1,20	0.048	15,90	0.625
CL-31+	47,65	1.875	13,50	0.531	40,45	1.593	25,40	1.000	14,25	0.562	1,55	0.062	1,20	0.048	15,90	0.625
CL-33	50,80	2.000	13,50	0.531	42,85	1.687	25,40	1.000	14,25	0.562	1,55	0.062	1,20	0.048	15,90	0.625
CL-36+	55,55	2.187	13,50	0.531	46,00	1.812	25,40	1.000	14,25	0.562	1,55	0.062	1,20	0.048	15,90	0.625
CL-37	57,15	2.250	13,50	0.531	46,00	1.812	25,40	1.000	14,25	0.562	1,55	0.062	1,20	0.048	15,90	0.625
CL-38+	58,70	2.312	13,50	0.531	49,20	1.937	25,40	1.000	14,25	0.562	1,55	0.062	1,20	0.048	15,90	0.625
CL-41+	63,50	2.500	13,50	0.531	50,80	2.000	25,40	1.000	14,25	0.562	1,55	0.062	1,20	0.048	15,90	0.625
CL-43	66,65	2.625	13,50	0.531	58,70	2.312	25,40	1.000	14,25	0.562	1,55	0.062	1,20	0.048	15,90	0.625

+Non-standard. Please contact Parker Hannifin Hose Products Division.

Accessory Selection Guide – HC, 88HC-H and 88DB Clamp

The Parker HC Clamp is a stainless steel worm gear clamp designed for low pressure industrial hose applications.

Material: Stainless steel

Specifications: SAE J1508, Type F and Type HD

HC Hose Clamp Table

Part Number	Size (SAE)	"A" Clamp Diameter			
		Minimum		Maximum	
		mm	inch	mm	inch
HC-6	-8	12	0.48	25	1.00
HC-8	-10	13	0.50	28	1.12
HC-10	-12	13	0.50	32	1.25
88HC-12	-16	19	0.75	38	1.50
88HC-16	-20	19	0.75	44	1.75
88HC-20	-24	25	1.00	51	2.00
88HC-24	-28	33	1.31	57	2.25

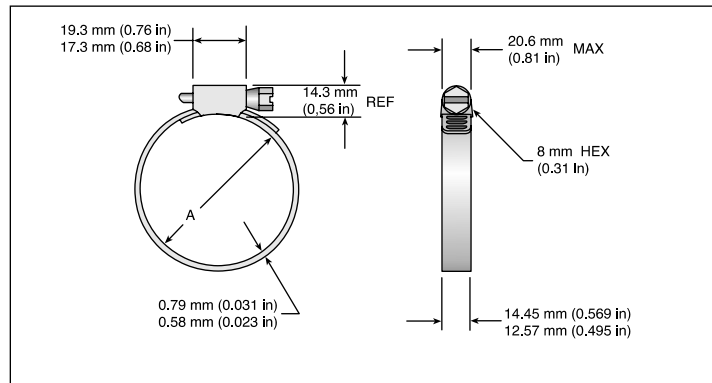

88HC-H Series Hose Clamp (High Torque Wormgear)

# Part Number	Hose I.D. inch
88HC-16H	3/4
88HC-16H	1
88HC-20H	1-1/4
88HC-32H	1-1/2
88HC-32H	2
88HC-40H	2-1/2
88HC-48H	3



Note: See 88 Series Assembly Instructions for proper 88HC-H clamp attachment.

88DB Series Heavy Duty Hose Clamp (Double Bolt Hose Clamp)

# Part Number	Hose I.D. inch
88DB-12	3/4
88DB-16	1
88DB-20	1-1/4
88DB-24	1-1/2
88DB-32	2

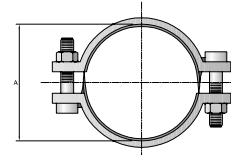

Accessory Selection Guide – Protection Shields (HP, HT, and HP-B)

Prevent hose abrasion while extending your hose life. Parker Hose Protection Shields extend hose life by protecting the hose from abrasion that occurs when hose rubs against other hose, metal or concrete. Parker hose shields are resistant to oil, lubricants, gasoline, most solvents and can withstand ambient temperatures from -40° to +300° F. Easily installed and secured by cable ties without disconnecting any hose lines. Use with hose from 1/4" to 2" I.D.

- ◆ Eliminate hose abrasion on concrete, metal or any rough surface.
- ◆ Guard against hose deterioration on mobile hydraulic equipment.
- ◆ Let Parker fill all your hydraulic and pneumatic hose product needs.

Hose Protector Shields are a fast and extremely cost effective way to isolate fluid lines from direct contact with other lines, components or structural members. They're available in 4-inch, 6-inch and 8-inch lengths and the width can be trimmed to satisfy a variety of situations.

These flexible protectors simply clamp around the hose and are securely held in place by nylon cable ties which are included. The cable ties are recessed in molded grooves to protect them from abrasion. **You don't need to disconnect a line to install a Parker Hose Protector Shield the way you do with a continuous tubular sleeve. Just wait until the installation is up and running to see exactly where contact needs to be prevented.**

Parker Hose Protector Shields are available in bulk quantities and in convenient assortments in 4", 6" and 8" sizes. Cable ties are included with all protectors and are also available in bulk.

Hose Shields

HP-B-13X18-KIT	2 ea. HP-B-13 RFL
	2 ea. HP-B-15 RFL
	4 ea. HP-B-18 RFL

Tie Wraps

HT-12-KIT	30 ea. HT-12 Tie Wraps
HT-16-KIT	30 ea. HT-16 Tie Wraps
HT-22-KIT	15 ea. HT-22 Tie Wraps

20 Hose Protectors and 60 Tie Wraps for each size are in point of purchase display box.

HP-B-13-RFL	10 ea. HP-B-13 Hose Protectors (4").
	30 ea. HT-12 Tie Wraps in a sealed plastic bag.
HP-B-15-RFL	10 ea. HP-B-15 Hose Protectors (6").
	30 ea. HT-16 Tie Wraps in a sealed plastic bag.
HP-B-18-RFL	5 ea. HP-B-18 Hose Protectors (8").
	15 ea. HT-22 Tie Wraps in a sealed plastic bag.

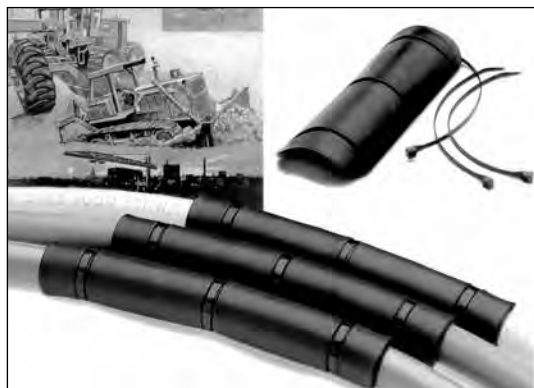

Contact your authorized Parker Hose Products Distributor for pricing and delivery information.

Note: Parker Hose Protector Shield products are intended to prevent damage. They are not suitable as patches or repairs for lines which are already damaged or worn beyond safe use standards.

A

B

C

D

E

HPD Hose Assembly Workstations

Hose Products Division has set up an agreement to enable our customers to purchase directly from our vendor, Safety Step.

<p>Safety Step's contact information is:</p>	<p>Safety Step Jeff Lewis 888-448-4237 jlewis@safetystep.net</p>
---	--

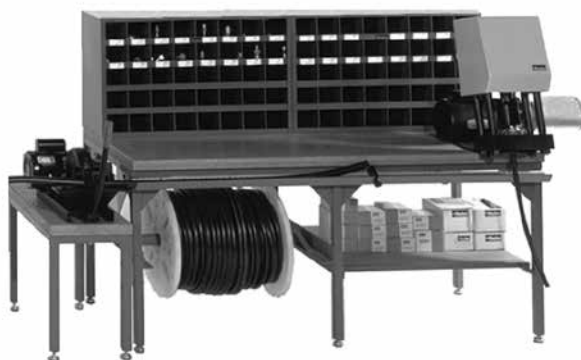

The complete on-site complete hose assembly workstation design (above) includes:

- TH7-5-C—6' table with 1 hose reel and 1 bottom shelf
- TH7-6—16 hose reel system, with rotating base
- TH7-7—15" wide table set up for Parker 239 or 339 Cut-Off Saw
- (2) 40B-Cabinet 40 openings - 4-1/2" x 4-1/2" x 12" in size
- TH7-6-C—Optional overhead crane
- TH7-5-HT—Optional 6' measured hose trough with adjustable hose stop

Specifications: HoseFab Table (heavy duty)

- Laminated wood table top
- 1-1/2" square tubing structure
- Gussetted corner braces
- 6-leg design
- All legs have adjustable feet
- Hose reel/shelf combinations
- 40B-Cabinet or 72B-Cabinet for fitting storage
- *Optional: Hose trough for measurement of hose*
 - Calibrated to line up to Saw Table
 - Adjustable stop for standard length cuts
 - Built-in tape measure

Specifications: Rotary Reel Rack (TH7-6)

- 16 Hose reel capacity
- Compact design
- Rotates for 1 man use
- Center post bolts to floor in 4 places
- Optional: Overhead crane

Specifications: Saw Table (TH7-7)

- Calibrated to line up to Hose trough
- Adjustable feet
- Mounts to 6-foot bench

Specifications: 3 or 4 Reel Rack

- Free standing 3 reel rack (TH7-8)
- Bolts to floor
- Optional: 4th reel capacity with wall mounts (TH7-8-F)



Pictured left is a complete on-site hose assembly workstation, the Parker Kart:

The **Parker Kart, TH7-4**, is a portable all-in-one unit designed to hold a Minikrimp, Karrykrimp, Karrykrimp 2, or Parkrimp 1; a 332T-115V Cut-off Saw; 4 reels of hose; and has a 40 bin cabinet with 3 drawers for tools. The TH7-4 can be customized to fit your specific hose assembly needs. Contact Parker HPD or your Parker Hose distributor for details.

Note: Part number TH7-4 does not include hose, fittings or equipment.

See Safety Step contact information at the top of this page

Note: Part number and specifications of components for both workstations are listed on the following pages.

HoseFab Table

Features

Heavy duty constructed table for mounting Minikrimp, Karrykrimp, Karrykrimp 2, or Parkrimp 1. HoseFab Table is available in 3 versions to meet your requirements. Options include two 40B-Cabinets or 72B-Cabinets for fitting storage.

Part Number	Description
TH7-5-R	6' table with 2 hose reels
TH7-5-S	6' table with 2 bottom shelves
TH7-5-C	6' table with 1 hose reel and 1 bottom shelf
TH7-5-HT	Optional 6' measured hose trough with adjustable hose stop
40B-Cabinet	40 openings - 4-1/2" x 4-1/2" x 12" in size
72B-Cabinet	72 openings - 4-1/2" x 4-1/2" x 12" in size

Table measurements:

Height - 31-3/4"
Width - 29"
Length - 72"



See Safety Step contact information on page D-28

Rotary Reel Rack

Features

16 Hose reel capacity that fits in a compact area. Supplied with heavy duty casters which allow for ease of turning, even when fully loaded. Optional overhead crane available.

Part Number	Description
TH7-6	16 hose reel system, with rotating base
TH7-6-C	Optional overhead crane

Rack measurements:

Height - 104" (120" with optional overhead crane)
Width - 67"
Length - 67"



See Safety Step contact information on page D-28

Saw Table

Features

The Saw Table, specially designed for Parker 239 or 339 Hose Cut-Off Saw, attaches directly to the HoseFab Table.

Part Number	Description
TH7-7	15" wide table set up for Parker 239 or 339 Cut-Off Saw

Table measurements:

Height - 18"
Width - 28"
Length - 14"



See Safety Step contact information on page D-28

3/4 Reel Rack

Features

Compact in its design, the standard version will hold 3 reels of hose. Optional 4th reel capacity designed with wall anchor mounts.

Part Number	Description
TH7-8	Upright 3 hose reel rack
TH7-8-F	Optional extension with wall anchor for 4th reel

Rack measurements:

Height - 59" (82-1/2" with 4th reel option)
Width - 27-3/4"
Length - 27-1/2"



See Safety Step contact information on page D-28

A

B

C

D

E

A



See Safety Step contact information on page D-28

Parker Kart Part No. TH7-4

Parker Kart organizes and stores all your necessary Parker hoses, fittings, power and hand tools - everything you need to make fast hose assemblies on site. As a valued addition to any facility, Parker Kart will save on downtime and labor costs, as well as eliminate errors in cutting and fitting attachment. With Parker Kart, you'll always have the materials you need, right when and where you need them.

- Easy one-man movement
- Eight-inch urethane casters with brakes
- Forklift carry tubes
- Electric receptacle with cord
- Fitting bins and drawers
- Large tool drawer
- Four hose reel holders
- Choice of Parker crimping equipment
- Optional accessories available

Parker Kart can be customized to fit specific hose assembly needs. Parker Kart does not include hose, fittings or equipment.

B

C



Fitting Stock Bins 72B-Cabinet

36" wide, 43" high, 12" deep, with 72 openings each 4-1/2" x 4-1/2" x 12", heavy duty steel, all welded construction. Product bin labels are available.

D



Hose Stock Bins HR6-Hose-Bin

Rugged metal cabinet for stocking coils of Parker hose 36" wide, 28" high, 20" deep, with upright separators to provide 6 compartments varying in width from 4" to 8".

Provides suitable base on which to place the fittings stock bin (top measures 36" x 20", bottom of fittings bin measures 36" x 12".)

Yellow with black "Parker Hose" lettering.

E



S T A M P

SIZE TEMPERATURE APPLICATION MEDIA PRESSURE

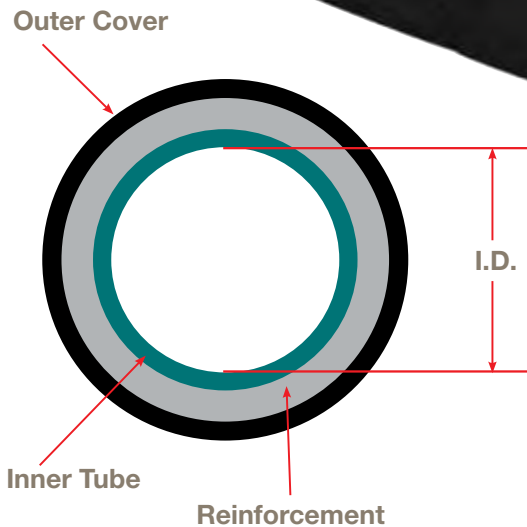

- Half SAE Bend
- Tough Cover
- SuperTough Cover
- High Temperature
- Low Temperature
- Compact

Comprehensive information that helps you connect with the right hose and fittings. Visit www.parkerhose.com for the latest technical data.

Technical E



ENGINEERING YOUR SUCCESS.

Table of Contents

Size

Flow Capacities at Recommended Flow Velocities E-3
 Hose Flow Capacities Pressure Drop.....E-4

Temperature

Temperature/Pressure Chart - 201, 206, 213, and 266 Hose.....E-5
 Minimum/ Maximum Temperature ChartE-6

Application

Hose Installation TipsE-10
 Ferrule-FixE-13
 Hose, Adapters and Fittings Standards and Specifications.....E-14
 Assembly MethodsE-17
 Identifying Fitting Types.....E-18
 Replacing Caterpillar® Flange FittingsE-27
 Thread Guide.....E-29
 Standard Fitting Configurations by Connection and End CodeE-30
 Metric Conversions.....E-32

Media

Chemical Resistance Information..... E-33

Pressure

Pressure Rating of Hose End ConnectionsE-43
 Metric Pressure ConversionsE-44
 PSI and MPa or N/mm2 Conversions.....E-45

 Part Number IndexE-46
 Fitting Size Identification Chart.....E-52

 Safety Guide & MSDS Statement.....E-54
 Offer of SaleE-58

Size

Flow Capacities at Recommended Flow Velocities

Flow capacity nomogram for the graphic determination of the inner diameter of hydraulic lines

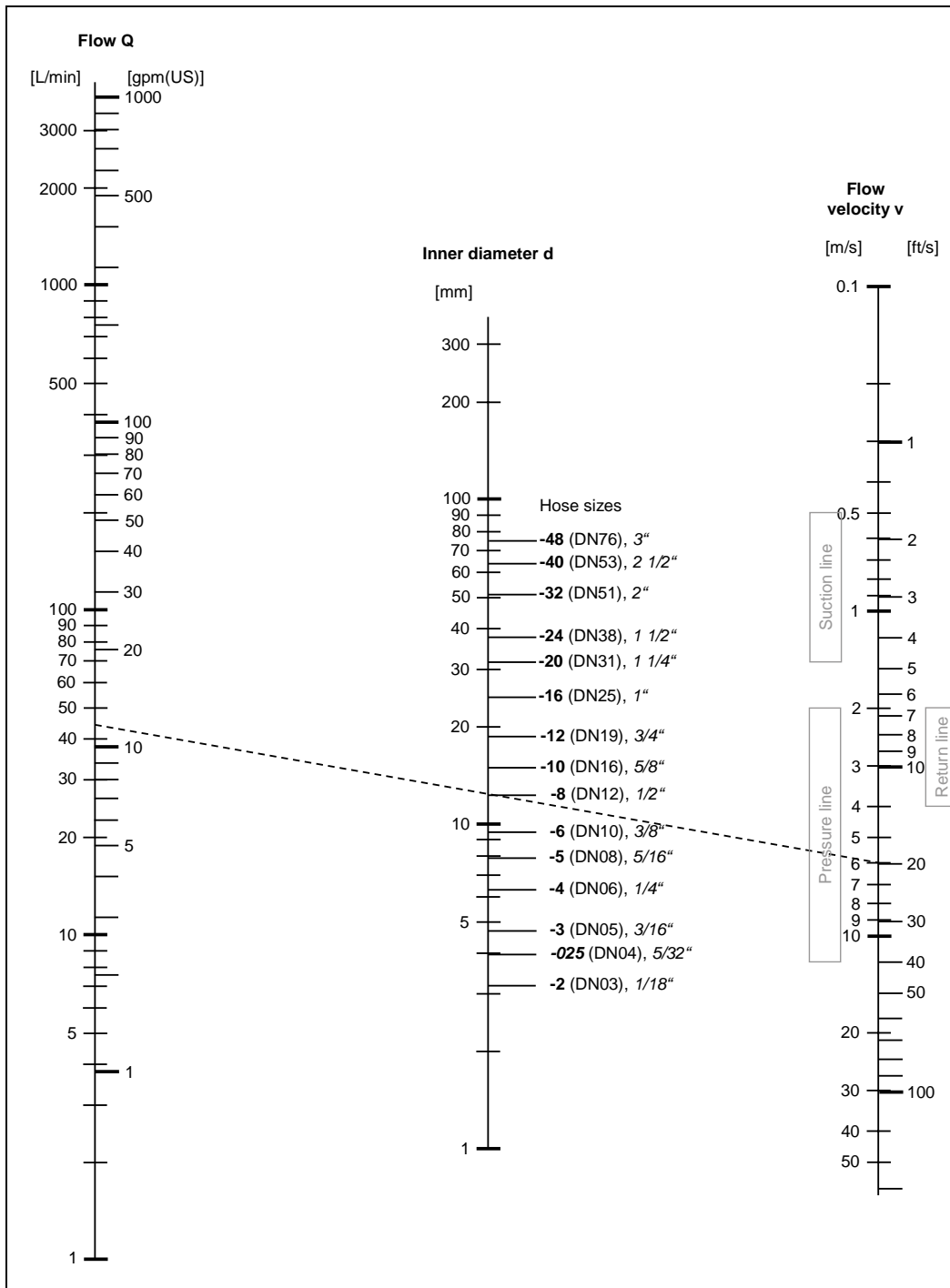

Note:

The chart is provided as an aid in the determination of the correct hose size. What is the proper hose size? Locate the flow in the left-hand column and in the right-hand column the maximum recommended velocity. Lay a straight line across these two points. The inside diameter shown in the center column is the result.

Example: given: Q = 45 L/min, v = 6 m/s; find: d; Solution see flow capacity nomogram.



Size

Hose Flow Capacities Pressure Drop

Hose Dash Size	-04		-05		-06		-08		-10		-12		-16		-20		-24		-32		-40		-48		
Hose I.D. (Inches)	0.19	0.25	0.25	0.31	0.31	0.38	0.41	0.50	0.50	0.63	0.63	0.75	0.88	1.00	1.13	1.25	1.38	1.50	1.81	2.00	2.38	3.00			
0.25	10.0	3.1	3.1																						
0.5	19.0	6.0	6.0	2.7	2.7																				
1	40.0	12.0	12.0	5.5	5.5	2.4																			
2	95.0	24.0	24.0	10.0	10.0	4.8	3.5																		
3	185.0	46.0	46.0	17.0	17.0	7.0	5.0	2.2	2.2																
4		78.0	78.0	29.0	29.0	12.0	8.0	3.0	3.0	1.2	1.2														
5		120.0	120.0	44.0	44.0	18.0	12.0	4.5	4.5	1.6	1.6	0.7													
8				95.0	95.0	39.0	26.0	10.0	10.0	3.6	3.6	1.4	0.6												
10						59.0	40.0	15.0	15.0	5.7	5.7	2.0	1.0	0.6											
12						80.0	52.0	20.0	20.0	7.2	7.2	2.6	1.5	0.8	0.4										
15							75.0	30.0	30.0	10.0	10.0	4.2	2.2	1.2	0.7	0.4									
18							107.0	40.0	40.0	15.0	15.0	6.3	3.0	1.5	0.7	0.6	0.4								
20								49.0	49.0	19.0	19.0	8.0	3.4	2.0	1.1	0.7	0.4	0.3							
25								72.0	72.0	26.0	26.0	11.0	5.5	3.0	1.6	1.0	0.6	0.4	0.2						
30										34.0	34.0	14.0	7.0	3.6	2.2	1.3	0.8	0.5	0.2	0.1					
35										47.0	47.0	19.0	9.5	5.0	2.8	1.7	1.1	0.7	0.3	0.2					
40												25.0	12.0	6.5	3.4	2.2	1.4	0.9	0.4	0.2					
50												36.0	17.0	9.0	5.3	3.3	2.0	1.3	0.5	0.4	0.2				
60												50.0	23.0	12.0	7.5	4.4	2.8	1.8	0.8	0.5	0.2				
70													31.0	17.0	9.3	6.0	3.8	2.4	1.0	0.7	0.3				
80													38.0	21.0	12.0	7.1	4.6	3.0	1.2	0.8	0.3	0.1			
90													49.0	27.0	15.0	9.0	5.9	3.8	1.5	1.0	0.5	0.1			
100														33.0	19.0	12.0	7.0	4.7	1.9	1.3	0.6	0.2			
150														60.0	36.0	22.0	13.0	8.5	3.4	2.2	1.0	0.3			
200															36.0	23.0	15.0	6.0	3.9	1.7	0.6				
250															54.0	33.0	22.0	8.5	5.3	2.5	0.8				
300																45.0	29.0	12.0	7.5	4.0	1.1				
400																	51.0	21.0	14.0	6.5	2.2				
500																		32.0	20.0	10.0	3.0				
800																					18.0	5.0			
1000																									10.0

Pressure drop in psi (pounds per square inch) per 10 feet of hose (smooth bore) without fittings.

Fluid specification: Specific gravity = 0.85; Viscosity = ν = 20 centistokes (C.S.), (20 C.S. = 97 S.S.U.)

Pressure drop values listed are typical of many petroleum based hydraulic oils at approximately +100°F (+38°C). Differences in fluids, fluid temperature and viscosity can increase or decrease actual pressure drop compared to the values listed.

T emperature

Temperature / Pressure Chart - 201, 206, 213, and 266 Hose

The Temperature / Pressure Chart identifies the effects temperature change has on the maximum working pressure of specific hoses.

How to use the chart:

- 1st - Identify the Maximum Working Pressure of selected hose.
- 2nd - Identify the maximum working temperature of the application.
- 3rd - Locate point where temperature and Percent of Maximum Working Pressure intersect on the chart.
- 4th - Based on percentage figure, calculate Maximum Working Pressue of the application.

Example: 201-8 hose to be used a 250°F (121°C)

Maximum Working Pressure up to 212°F (100°C)	x	(Multiplier from chart)	=	Maximum Working Pressure at 250°F (121°C)
2,000 psi	x	(85%)	=	1,700 psi

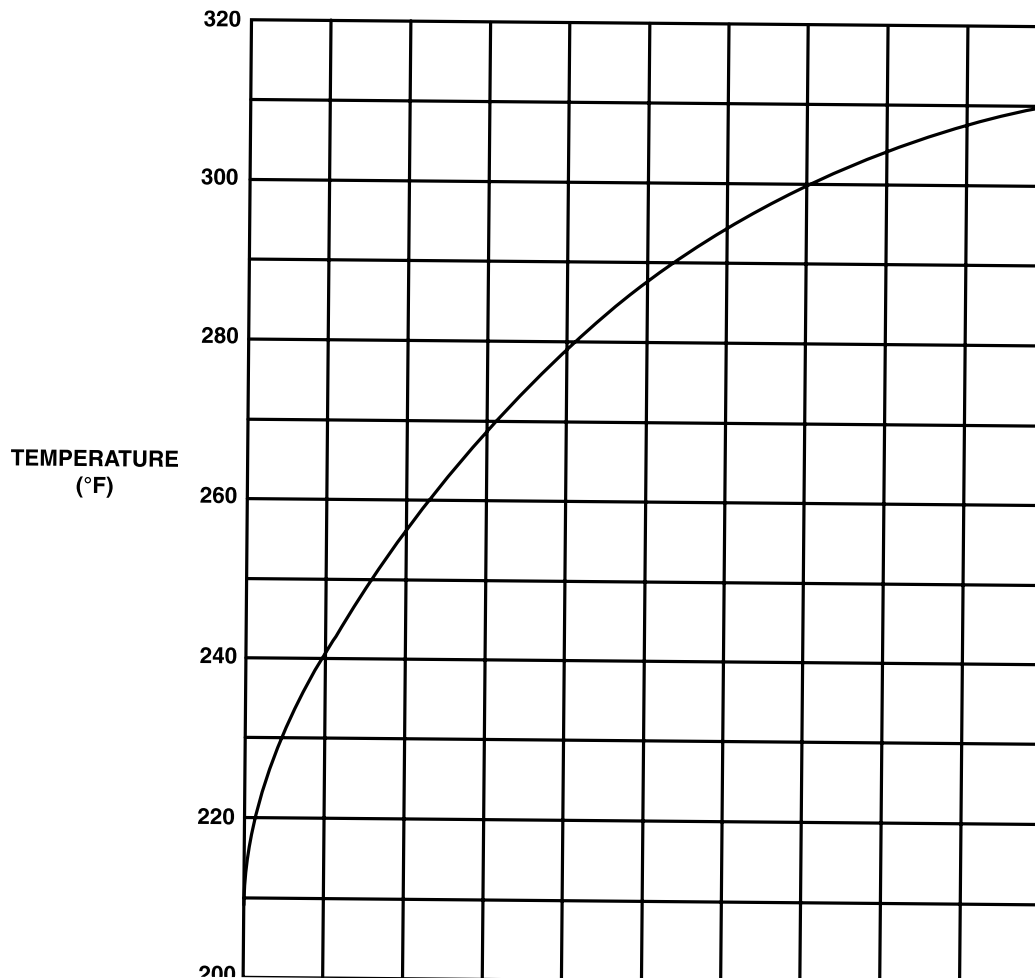

T emperature

Minimum/Maximum Temperature

(Page 1 of 4)

Hose	Petroleum base hydraulic fluids and lubricating oils	Antifreeze solutions	Diesel fuels	SAE J1942 Marine lube oil and diesel fuel systems (Application Code F)**
201*	-40°C to +150°C (-40°F to +302°F)	-40°C to +150°C (-40°F to +302°F)	-40°C to +150°C (-40°F to +302°F)	x
206*	-48°C to +150°C (-55°F to +302°F)	-48°C to +150°C (-55°F to +302°F)	-48°C to +150°C (-55°F to +302°F)	x
213*	-45°C to +150°C (-50°F to +302°F)	-45°C to +150°C (-50°F to +302°F)	-45°C to +150°C (-50°F to +302°F)	x
221FR	-20°C to +100°C (-4°F to +212°F)	x	-20°C to +100°C (-4°F to +212°F)	-20°C to +100°C (-4°F to +212°F)
266*	-48°C to +150°C (-55°F to +302°F)	-48°C to +150°C (-55°F to +302°F)	-48°C to +150°C (-55°F to +302°F)	x
271	x	x	x	x
293	-50°C to +150°C (-58°F to +302°F)	-50°C to +150°C (-58°F to +302°F)	-50°C to +150°C (-58°F to +302°F)	x
302	-40°C to +100°C (-40°F to +212°F)	x	x	-40°C to +100°C (-40°F to +212°F)
304	x	x	x	x
351TC/ST	-40°C to +100°C (-40°F to +212°F)	x	x	x
422	-40°C to +100°C (-40°F to +212°F)	x	x	-40°C to +100°C (-40°F to +212°F)
424	x	x	x	x
426	-46°C to +150°C (-50°F to +302°F)	x	x	-46°C to +150°C (-50°F to +302°F)
431	-40°C to +125°C (-40°F to +257°F)	x	x	x
436	-48°C to +150°C (-55°F to +302°F)	x	x	x
451TC/ST	-40°C to +100°C (-40°F to +212°F)	x	x	x
471TC/ST	-40°C to +100°C (-40°F to +212°F)	x	x	x
472LT	-57°C to +100°C (-70°F to +212°F)	x	x	x
472TC	-40°C to +100°C (-40°F to +212°F)	x	x	x
482TC/ST	-40°C to +100°C (-40°F to +212°F)	x	x	x
611HT	-48°C to +150°C (-55°F to +302°F)	-45°C to +150°C (-55°F to +302°F)	-45°C to +150°C (-55°F to +302°F)	x
701	-40°C to +100°C (-40°F to +212°F)	x	x	x
711	-40°C to +100°C (-40°F to +212°F)	x	x	x
721	-40°C to +125°C (-40°F to +257°F)	x	x	x
721TC/ST	-40°C to +125°C (-40°F to +257°F)	x	x	x
722LT	-57°C to +100°C (-70°F to +212°F)	x	x	x
772LT	-57°C to +100°C (-70°F to +212°F)	x	x	x
722TC	-40°C to +125°C (-40°F to +257°F)	x	x	x
792LT	-57°C to +100°C (-70°F to +212°F)	x	x	x
787TC	-40°C to +125°C (-40°F to +257°F)	x	x	x
797TC	-40°C to +125°C (-40°F to +257°F)	x	x	x
F42	x	x	x	x
301LT	-55°C to +100°C (-67°F to +212°F)	x	x	x

* The maximum working pressures for these hoses are reduced at temperatures above +212°F (+100°C). Consult the pressure/temperature curve on E-5 for the reduced maximum working pressure.

** Maximum service pressure for lube oil and fuel systems applications (Code F) may be less than maximum service pressure for other systems applications, e.g., Code H. Refer to individual hose listings in Section A and Hose Assemblies List, SAE J1942-1 or HPD Approval Bulletin #APR-004.

T emperature

Minimum/Maximum Temperature

(Page 2 of 4)

Hose	Petroleum base hydraulic fluids and lubricating oils	Antifreeze solutions	Diesel fuels	SAE J1942 Marine lube oil and diesel fuel systems (Application Code F)**
731	-40°C to +100°C (-40°F to +212°F)	x	x	x
761	-40°C to +125°C (-40°F to +257°F)	x	x	x
772TC/ST	-40°C to +125°C (-40°F to +257°F)	x	x	x
772LT	-50°C to +100°C (-70°F to +212°F)	x	x	x
774	x	x	x	x
787TC	-40°C to +125°C (-40°F to +257°F)	x	x	x
781	-40°C to +125°C (-40°F to +257°F)	x	x	x
782TC/ST	-40°C to +125°C (-40°F to +257°F)	x	x	x
P35	-40°C to +125°C (-40°F to +257°F)	x	x	x
791TC	-40°C to +125°C (-40°F to +257°F)	x	x	x
792TC/ST	-40°C to +125°C (-40°F to +257°F)	x	x	x
797TC	-40°C to +125°C (-40°F to +257°F)	x	x	x
801	-40°C to +100°C (-40°F to +212°F)	-40°C to +100°C (-40°F to +212°F)	x	x
804	x	x	x	x
811	-40°C to +100°C (-40°F to +212°F)	x	x	x
821	-40°C to +100°C (-40°F to +212°F)	-40°C to +100°C (-40°F to +212°F)	x	x
821FR	-40°C to +100°C (-40°F to +212°F)	-40°C to +100°C (-40°F to +212°F)	x	x
836	-48°C to +150°C (-55°F to +302°F)	-48°C to +150°C (-55°F to +302°F)	x	x
881	-40°C to +125°C (-40°F to +257°F)	x	x	x
AX	-40°C to +100°C (-40°F to +212°F)	x	x	x
BXX	-40°C to +100°C (-40°F to +212°F)	x	x	x
JK	-40°C to +49°C (-40°F to +120°F)	x	x	x
SS23CG	x	x	x	x
SS25UL	x	x	x	x
811HT	-46°C to +125°C (-50°F to +257°F)	x	x	x

* The maximum working pressures for these hoses are reduced at temperatures above +212°F (+100°C). Consult the pressure/temperature curve on E-5 for the reduced maximum working pressure.

** Maximum service pressure for lube oil and fuel systems applications (Code F) may be less than maximum service pressure for other systems applications, e.g., Code H. Refer to individual hose listings in Section A and Hose Assemblies List, SAE J1942/1 or HPD Approval Bulletin #APR-004.



T emperature

Minimum/Maximum Temperature

(Page 3 of 4)

A

B

C

D

E

Hose	Air	Water, water/oil emulsion	Water/glycol hydraulic	Water	Phosphate ester fluids	Polyol ester fluids
201*	+70°C (+158°F)	+85°C (+185°F)	+85°C (+185°F)	+85°C (+185°F)	x	x
206*	+100°C (+212°F)	+85°C (+185°F)	+85°C (+185°F)	+85°C (+185°F)	x	x
213*	+100°C (+212°F)	+85°C (+185°F)	+85°C (+185°F)	+85°C (+185°F)	x	x
221FR	+70°C (+158°F)	+85°C (+185°F)	+85°C (+185°F)	+85°C (+185°F)	x	x
266*	+93°C (+200°F)	+85°C (+185°F)	+85°C (+185°F)	+85°C (+185°F)	x	x
271	100°C (212°F)	x	x	x	x	x
293	+93°C (+200°F)	+85°C (+185°F)	+85°C (+185°F)	+85°C (+185°F)	x	x
302	+70°C (+158°F)	+85°C (+185°F)	+85°C (+185°F)	+85°C (+185°F)	x	x
304	+70°C (+158°F)	x	+85°C (+185°F)	+85°C (+185°F)	-40°C to +80°C (-40°F to +176°F)	x
351TC/ST	+70°C (+158°F)	+85°C (+185°F)	+85°C (+185°F)	+85°C (+185°F)	x	x
422	+70°C (+158°F)	+85°C (+185°F)	+85°C (+185°F)	+85°C (+185°F)	x	x
424	+70°C (+158°F)	x	+85°C (+185°F)	+85°C (+185°F)	-40°C to +80°C (-40°F to +176°F)	x
426	+70°C (+158°F)	+85°C (+185°F)	+85°C (+185°F)	+85°C (+185°F)	x	x
431	+70°C (+158°F)	+85°C (+185°F)	+85°C (+185°F)	+85°C (+185°F)	x	x
436	+70°C (+158°F)	+85°C (+185°F)	+85°C (+185°F)	+85°C (+185°F)	x	x
451TC/ST	+70°C (+158°F)	+85°C (+185°F)	+85°C (+185°F)	+85°C (+185°F)	x	x
471TC/ST	+70°C (+158°F)	+85°C (+185°F)	+85°C (+185°F)	+85°C (+185°F)	x	x
472LT	+70°C (+157°F)	+85°C (+185°F)	+85°C (+185°F)	+85°C (+185°F)	x	
472TC	+70°C (+158°F)	+85°C (+185°F)	+85°C (+185°F)	+85°C (+185°F)	x	+65°C (+150°F)
482TC/ST	+70°C (+158°F)	+85°C (+185°F)	+85°C (+185°F)	+85°C (+185°F)	x	+65°C (+150°F)
611HT	+100°C (+212°F)	+85°C (+185°F)	+85°C (+185°F)	+85°C (+185°F)	x	x
701	+70°C (+158°F)	+85°C (+185°F)	+85°C (+185°F)	+85°C (+185°F)	x	x
772LT	+70°C (+158°F)	+85°C (+185°F)	+85°C (+185°F)	+85°C (+185°F)	x	x
722LT	x	x	x	x	x	x
722TC	+70°C (+158°F)	+85°C (+185°F)	+85°C (+185°F)	+85°C (+185°F)	x	x
792LT	+70°C (+158°F)	+85°C (+185°F)	+85°C (+185°F)	+85°C (+185°F)	x	x
787TC	+70°C (+158°F)	+85°C (+185°F)	+85°C (+185°F)	+85°C (+185°F)	x	x
797TC	+70°C (+158°F)	+85°C (+185°F)	+85°C (+185°F)	+85°C (+185°F)	x	x
F42	+70°C (+158°F)	x	+85°C (+185°F)	+85°C (+185°F)	-40°C to +80°C (-40°F to +176°F)	x
301LT	+70°C (+158°F)	+85°C (+185°F)	+85°C (+185°F)	+85°C (+185°F)	x	x

* The maximum working pressures for these hoses are reduced at temperatures above +212°F (+100°C). Consult the pressure/temperature curve on E-5 for the reduced maximum working pressure.

** Maximum service pressure for lube oil and fuel systems applications (Code F) may be less than maximum service pressure for other systems applications, e.g., Code H. Refer to individual hose listings in Section A and Hose Assemblies List, SAE J1942/1 or HPD Approval Bulletin #APR-004.

Temperature

Minimum/Maximum Temperature

(Page 4 of 4)

Hose	Air	Water, water/oil emulsion	Water/glycol hydraulic	Water	Phosphate ester fluids	Polyol ester fluids
711	+70°C (+158°F)	+85°C (+185°F)	+85°C (+185°F)	+85°C (+185°F)	x	x
721	+70°C (+158°F)	+85°C (+185°F)	+85°C (+185°F)	+85°C (+185°F)	x	x
721TC/ST	+70°C (+158°F)	+85°C (+185°F)	+85°C (+185°F)	+85°C (+185°F)	x	x
731	+70°C (+158°F)	+85°C (+185°F)	+85°C (+185°F)	+85°C (+185°F)	x	x
761	+70°C (+158°F)	+85°C (+185°F)	+85°C (+185°F)	+85°C (+185°F)	x	x
772TC/ST	+70°C (+158°F)	+85°C (+185°F)	+85°C (+185°F)	+85°C (+185°F)	x	+65°C (+150°F)
772LT	x	x	x	x	x	x
774	+70°C (+158°F)	x	+85°C (+185°F)	+85°C (+185°F)	-40°C to +80°C (-40°F to +176°F)	x
787TC	x	x	x	x	x	x
781	+70°C (+158°F)	+85°C (+185°F)	+85°C (+185°F)	+85°C (+185°F)	x	x
782TC/ST	+70°C (+158°F)	+85°C (+185°F)	+85°C (+185°F)	+85°C (+185°F)	x	+65°C (+150°F)
P35	+70°C (+158°F)	+85°C (+185°F)	+85°C (+185°F)	+85°C (+185°F)	x	x
797TC	x	x	x	x	x	x
791TC	+70°C (+158°F)	+85°C (+185°F)	+85°C (+185°F)	+85°C (+185°F)	x	x
792TC/ST	+70°C (+158°F)	+85°C (+185°F)	+85°C (+185°F)	+85°C (+185°F)	x	+65°C (+150°F)
801	+70°C (+158°F)	+85°C (+185°F)	+85°C (+185°F)	+85°C (+185°F)	x	x
804	+70°C (+158°F)	x	+93°C (+200°F)	+93°C (+200°F)	+80°C (+176°F)	x
811	+70°C (+158°F)	+85°C (+185°F)	+85°C (+185°F)	+85°C (+185°F)	x	x
821	+70°C (+158°F)	+85°C (+185°F)	+85°C (+185°F)	+85°C (+185°F)	x	x
821FR	+100°C (+212°F)	+85°C (+185°F)	+85°C (+185°F)	+85°C (+185°F)	x	x
836	+100°C (+212°F)	+85°C (+185°F)	+85°C (+185°F)	+85°C (+185°F)	x	x
881	+70°C (+158°F)	+85°C (+185°F)	+85°C (+185°F)	+85°C (+185°F)	x	x
AX	+70°C (+158°F)	+85°C (+185°F)	+85°C (+185°F)	+85°C (+185°F)	x	x
BXX	+70°C (+158°F)	+85°C (+185°F)	+85°C (+185°F)	+85°C (+185°F)	x	x
JK	x	x	x	x	x	x
SS23CG	x	x	x	x	x	x
SS25UL	x	x	x	x	x	x
811HT	+70°C (+158°F)	+85°C (+185°F)	+85°C (+185°F)	+85°C (+185°F)	x	x

* The maximum working pressures for these hoses are reduced at temperatures above +212°F (+100°C). Consult the pressure/temperature curve on E-5 for the reduced maximum working pressure.

** Maximum service pressure for lube oil and fuel systems applications (Code F) may be less than maximum service pressure for other systems applications, e.g., Code H. Refer to individual hose listings in Section A and Hose Assemblies List, SAE J1942/1 or HPD Approval Bulletin #APR-004.



A Application

Hose Installation Tips

wrong

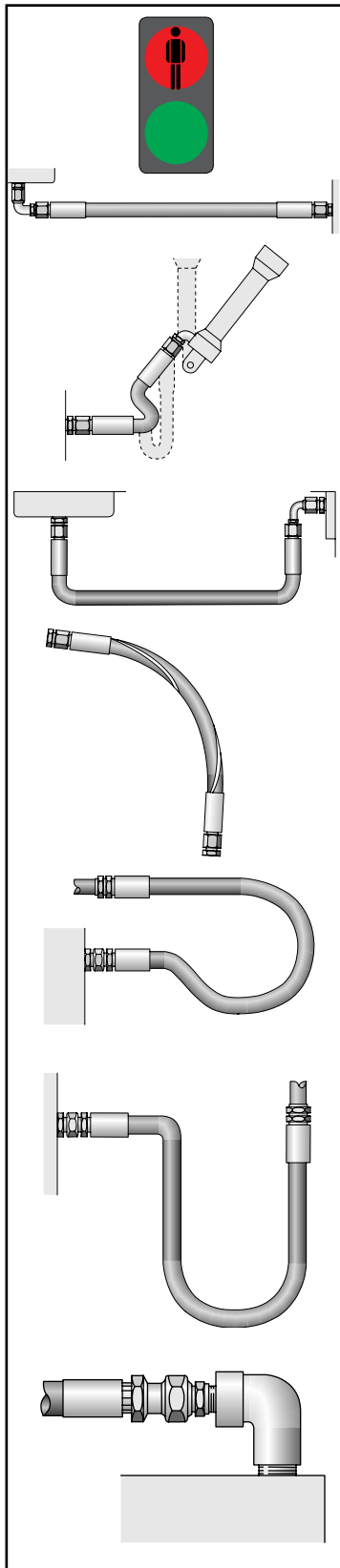

The routing of the hose assembly and the environment in which the hose assembly operates directly influence the service life of the hose assembly. The following diagrams indicate the correct routing of hose assemblies that will maximise its service life and assure a safe working functionality.

When hose installation is straight, there must be enough slack in the hose to allow for changes in length that occur when pressure is applied. When pressurized, hose that is too short may pull loose from its hose fittings or stress the hose fitting connections, causing premature metallic or seal failures.

The hose length must be determined so that the hose assembly has enough slack to allow the system components to move or vibrate without creating tension in the hose.

However, do not to allow too much slack and therefore introduce the risk of the hose snagging on other equipment or rubbing on other components.

Mechanical straining of the hoses needs to be avoided, so the hose must not be bent below its minimum bend radius or twisted during installation. The minimum bending radii for each hose is stated in the hose tables in the catalogue.

The plane of movement must also be considered and the hose routing selected accordingly.

Hose routing also plays an important role on the selection of the hose fittings, as the correct fittings can avoid straining the hoses, unnecessary hose length or multiple threaded joints.

right

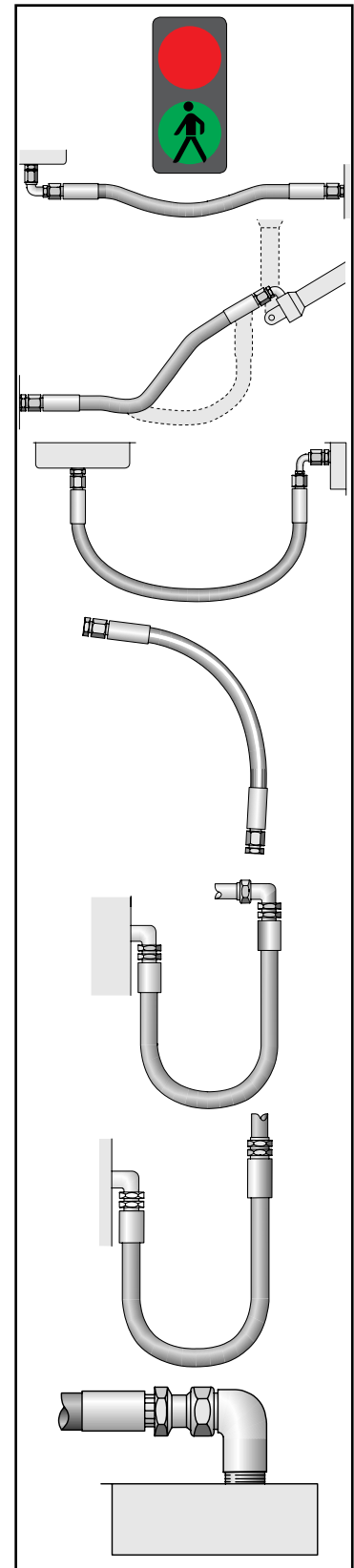

A

B

C

D

E

wrong

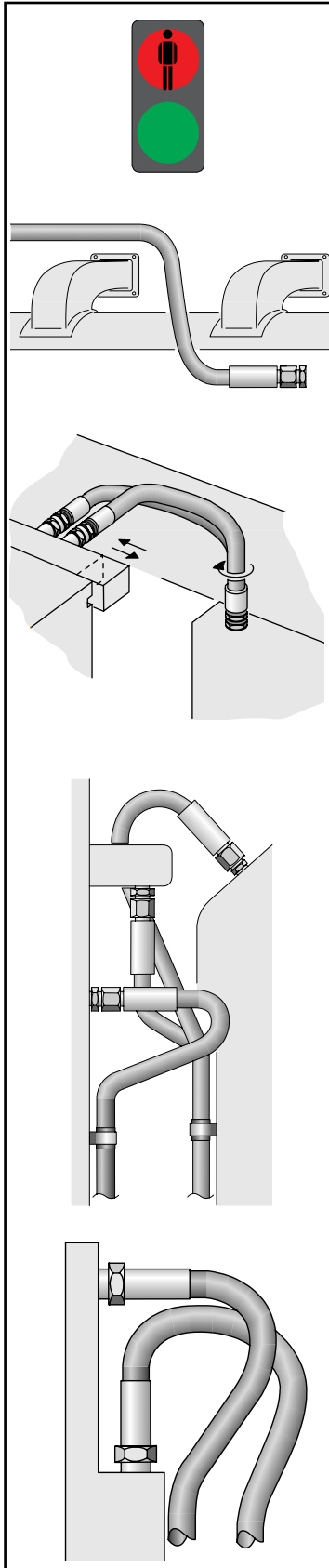

Correct clamping (holding/supporting) of the hose should be exercised to securely route the hose or to avoid the hose contacting surfaces that will cause the hose damage. It is however, vital that the hose be allowed to keep its functionality as a “flexible-pipe” and not be restricted from changing in length when under pressure.

It should also be noted that hoses for high- and low-pressure lines shall not be crossed or clamped together, as the difference in changes in length could wear the hose covers.

Hose should not be bent in more than one plane. If hose follows a compound bend, it shall be coupled into separate segments or clamped into segments that each flex in only one plane.

Hoses should be kept away from hot parts as high ambient temperatures shorten hose life. Protective insulation may need to be used in unusually high ambient temperature areas.

While the importance of the functionality is primary, the aesthetics and practicality of the installation should also be considered in the design. Maintenance might be necessary at some point in the future, so prohibitive design routings should be avoided.

right

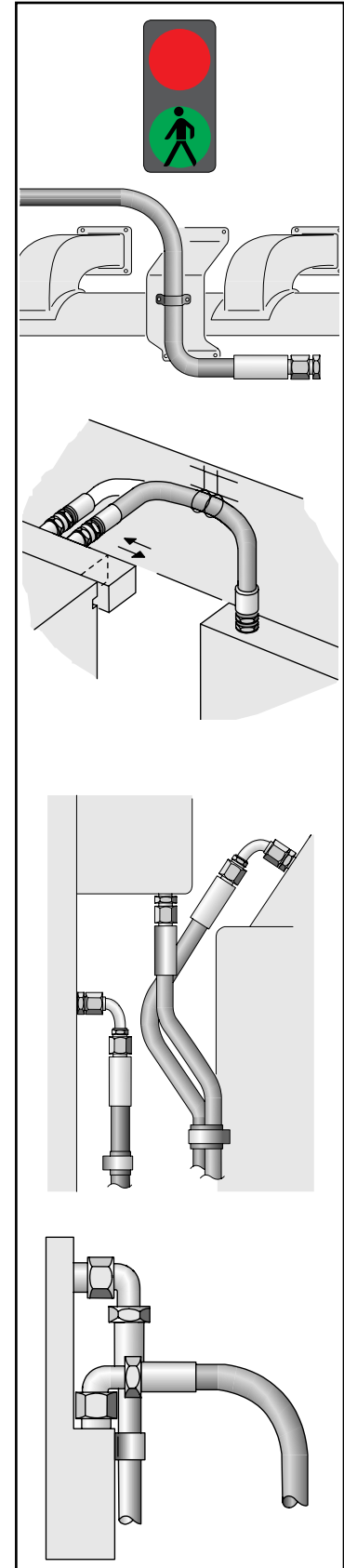

A

B

C

D

E

wrong

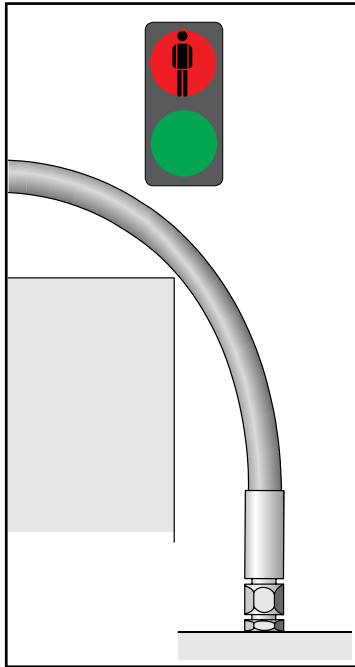

Abrasive influences

In general care should be taken so that the hose is not exposed to direct surface contact that will cause abrasive wearing of the outer cover (either hose to object or hose to hose contact). If however, the application is such that this cannot be avoided, either a hose with a higher abrasion resistant hose cover or a protective sleeve need to be used.

Parker **TOUGH COVER** (TC) or **SUPER TOUGH** (ST) covers offer 80 times or respectively 1000 times the abrasion resistance of standard rubber covers.

right

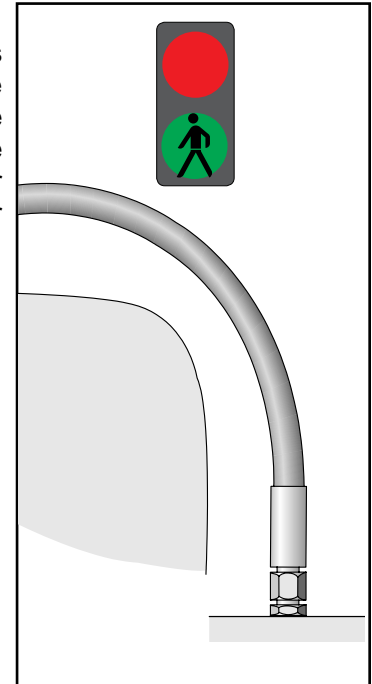

A

B

C

D

E

A Application

Ferrule-Fix

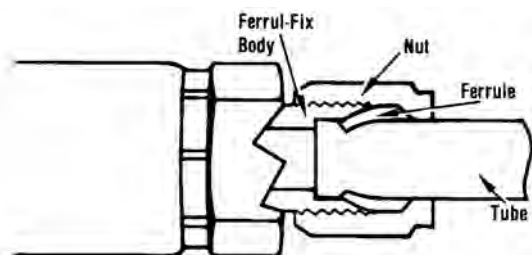

Fast, on-the-job repair for ruptured bent tube hose assemblies and power steering lines.

The life of the combination tube-hose assembly is often limited to the service life of the hose alone. A replacement assembly may not be available, some equipment dealers are unable to stock all of the many odd tube configurations.

Parker FERRUL-FIX, a field attachable, reusable hose end fitting, now makes it possible to salvage the bent tube section of the original assembly for replacement. Most important, it gets you back into operation FAST!

- Gets you back in operation fast - No costly delays while replacement assemblies are rushed from the factory.
- Lets you reuse expensive bent tube ends with Parker Hose fittings - You can replace the hose at a fraction of the cost of complete assembly.

- Eliminates the need for emergency brazing or welding in the field - Ferrul-Fix can be assembled without special tools or equipment when using Parker Reusable Hose fittings.

3-Piece Design - Body, nut and ferrule. Wedging action of ferrule, when drawn down by nut, forms seal between body and ferrule, while cutting edge of ferrule "bites" into tube wall forming another positive seal.

Visible Bite - Extent of bite at cutting edge of ferrule is completely visible when fitting is dis-assembled, an important safety feature. Self-centering action assures even bite around circumference of tube.

Parkerized Finish - Ferrul-Lok fittings have the Parkerized black finish, providing "built-in" lubrication which reduces wrench torque required.

Ferrul-Fix Installation Instructions



1. Cut the formed tube off squarely next to the permanent hose fitting. Lightly deburr the end of the tube internally and externally.
2. Disassemble the Ferrul-Fix fitting, and lubricate threads and both ends of the ferrule with Parker Ferulube.
3. Slide nut and ferrule onto tubing, with the long, straight end of the ferrule pointing toward the tube end.
4. Insert tube end into the Ferrul-Fix body until it bottoms against the shoulder. Slide ferrule inside body, and screw nut down finger tight.
5. Wrench nut down 1-3/4 turns to preset the ferrule.
6. Disconnect nut and inspect lead edge of ferrule to make certain that the biting edge has turned up a shoulder to a height of at least 50% of the ferrule and completely around the tube.
7. Assemble Ferrul-Fix fitting to hose. Refer to assembly instructions listed in appropriate fittings section. Do not assemble to hose before steps 1-6.
8. Reassemble tubing into Ferrul-Fix end and turn nut down easily until a sudden increase in force is evident. Turn bent tube to proper position if required. Using two wrenches, one on the fitting nipple hex and the other on the nut tighten nut an additional 1/6 turn (one wrench flat).

A

B

C

D

E

A pplication

Performance Standards and Specifications

Hose	SAE J517	SAE Other	DOT FMVSS 106	USCG MTH (1)	ISO	DNV (2)	EN	MSHA (3)	German Lloyd	ABS	UL-21 LPG	BV	Other
AX		J1942		H				X					
BXX		J1942		H				X					
F42													
JK	100R2AT				ISO 1436-1 Type 2SN		EN 853 Type 2 SN	X					1J100, NFPA 1936
MX	100R1AT	J1942		H				X					
P35	100R13	J1942		HF	ISO 3862-1 Type R13	X	EN 853 Type R13	X		X		X	
SS23CG											X		CAN/CGA-8.1-M86 Type III, ECE 110 Class 1
SS25UL											X		AGA - AS/NZS 1869D
201	100R5	J1402 All	All										
206	100R5	J1402 All	All										
213		J1402 AI	AI										
221FR (4)		J1527 R3, J1942, USCG A1		H, HF	ISO 7840			X	X	X			ABYC
244		J2064 Type B											
266		J1402 All	All										
285		J2064 Type C											
293		J1402 AI	AI										
301LT		J1942		HF		X				X			
302	100R2AT	J1942		HF	ISO 1436-1 Type 2SN	X	EN 853 Type 2 SN			X		X	
304													
351ST	100R19							X					
351TC	100R19							X					
422	100R1AT	J1942		HF	ISO 1436-1 Type 1SN	X	EN 853 Type 1SN			X			
424													
426	100R1AT	J1942		HF				X		X			
431		J1942		H				X					
436		J1942		HF				X		X			
451ST	100R17							X					
451TC	100R17	J1942		HF				X		X			
471ST					ISO 11237-1 Type 2SC		EN857 Type 2SC	X					
471TC	100R16	J1942		HF	ISO 11237-1 Type 2SC	X	EN857 Type 2SC	X		X		X	
472LT							EN857 Type 2SC						
472TC		J1942		HF	ISO 11237-1 Type 2SC	X	EN857 Type 2SC	X		X			
482ST	100R1AT				ISO 1436-1 Type 1SN		EN853 Type 1SN	X					

KEY TO UNDERSTANDING AGENCY APPROVALS FOR BUILDING HOSE ASSEMBLIES

ABS Approved assemblies can be manufactured at any location with Parker's permission. No restrictions.
 DNV Approved assemblies can only be manufactured in a Parker approved location that demonstrates a quality system and management program is in place and must be audited by DNV. Each location must be granted a "license" issued by Parker HPD for building hose assemblies. Three exist today; Davenport Iowa, Grimsby Canada, and Yangsan Korea.

BV Approved assemblies can only be produced in a BV approved location that demonstrates a quality system and management program is in place. Each location must have an initial audit performed by BV before the "license" can be issued. Additionally, ongoing audits setup by BV will be required at each approved location. Davenport Iowa is our only approved assembler.

UL "Listed" CSA/CGA Assemblies must be made at Davenport Iowa
 Assemblies must be made at Davenport Iowa



A Application Performance Standards and Specifications

Continued from previous page

Hose	SAE J517	SAE Other	DOT FMVSS 106	USCG MTH (1)	ISO	DNV (2)	EN	MSHA (3)	German Lloyd	ABS	UL-21 LPG	BV
482TC	100R1AT	J1942		H	ISO 1436-1 Type 1SN		EN853 Type 1SN	X				
611HT	100R6						EN854	X				
701		J1942		H, HF	ISO 3862-1 Type 4SP		EN856-Type 4SP			X		
711		J1942		HF		X		X		X		
721	100R12				ISO 3862-1 Type R12		EN856-Type R12	X				
721ST	100R12				ISO 3862		EN856	X				
721TC	100R12	J1942		HF	ISO 3862-1 Type R12	X	EN856-Type R12	X		X		
722LT	100R12				ISO 3862-1 Type R12		EN856-Type R12					
722TC		J1942		HF		X		X		X		
731		J1942		HF		X	EN856-Type 4SH			X		
761								X				
772LT												
772ST	100R12				ISO 3862-1 Type R12		EN856-Type R12	X				
772TC	100R12	J1942		HF	ISO 3862-1 Type R12	X	EN856-Type R12	X		X		
774												
781	100R13	J1942		HF	ISO 3862-1 Type R13	X	EN856-Type R13	X		X		
782ST	100R13				ISO 3862-1 Type R13		EN856-Type R13	X				
782TC	100R13	J1942		HF	ISO 3862-1 Type R13	X	EN856-Type R13	X		X		X
787TC		J1754, J1942		HF	ISO18752-DC	X		X		X		
791TC	100R15	J1942		HF	ISO 3862-1 Type R15	X		X		X		
792ST	100R15				ISO 3862-1 Type R15			X				
792TC	100R15	J1942		HF	ISO 3862-1 Type R15	X		X		X		
797TC		J1754, J1942		HF	ISO18752-DC	X		X		X		
801								X				
804												
811HT with 81		J1942		HF								
821												
821FR												
836								X				
881		J1942		H, HF				X				

Notes:

(1) U.S.C.G./MTH (Marine Technical & Hazardous Materials Branch) hoses, hose assemblies and appropriate fittings meet 46CFR56.60-25(c) for use on commercial vessels. Hoses and hose assemblies meet the requirements of SAE J1942. Hose fittings meet the requirements of SAE J1475.

F = Fuel and lube systems.
H = Hydraulic Systems.

*Some hoses are accepted for different pressures for F and H. Also, not all sizes are accepted for all applications. See HPD approval bulletin #APR-004 or consult the Parker Hose Products Division, Technical Services Department, for details. The Canadian Coast Guard accepts all hoses accepted by the U.S. Coast Guard.

(2) Det Norske Veritas (DnV) approvals are with permanent (crimp) type fittings only. See HPD Approval Bulletin #APR-006 or consult the Parker Hose Products Division, Technical Services Department, for details.

(3) Hose with MSHA (Mine Safety and Health Administration) approved flame resistant cover will be marked accordingly on the layline.

(4) 221FR is type accepted by Lloyd's Register. It meets the requirements of the American Boat and Yacht Council. 221FR is certified to meet the EC Directive 94/25/EC in accordance with ISO 7840.

For questions on standards and specifications please contact the Hose Products' Technical Services Department at (440) 943-5700.



A pplication

Standards and Specifications

JIS - Adapters

JIS B8363 Code	Parker Part Number	Mates with End Configuration
A1	F3T4	FU
A2	F3P4	GU
A3	F63P4	UT
E1	C3T4	FU
E2	C3P4	GU
E3	V3T4	FU
E4	V3P4	GU

Note: See website at www.Parker/tfd.com, Catalog 4300 or call (614) 279-7070 for additional information.

JIS - Hose Fittings

JIS B8363 Code	Parker End Configuration Code	Fitting Series 43	Fitting Series 70	Fitting Series 71	Fitting Series 73	Fitting Series 78	Fitting Series 79
R	UT	X		X			
F	FU	X		X			
C	GU	X	X	X	X	X	
MF	MU	X		X			
S	15	X	X	X	X	X	
4S	17	X	X	X	X	X	
9S	19	X	X	X	X	X	
H	6A		X	X	X	X	X
4H	6F			X	X	X	X
9H	6N		X	X	X	X	X

Note: Parker Hose Standards are listed on page E-14 and E-15

A pplication

Assembly Methods

JIC 37° and SAE 45° Flare

Parker's recommended assembly method for JIC 37° flare and SAE 45° flare is the Flats From Wrench Resistance (FFWR) method. This includes steel as well as other materials.

The torque values assigned by size are for reference only, and are only applicable to Parker system components using the FFWR method with trivalent chromate passivation on zinc plating of carbon steel components without lubrication.

Dash Size	Flats From Wrench Resistance (FFWR)	Swivel Nut Torque	
		Newton Meters (Ref)	Pound Feet (Ref)
-4	2	18	13
-5	2	23	17
-6	1-1/2	30	22
-8	1-1/2	57	42
-10	1-1/2	81	60
-12	1-1/4	114	84
-16	1	160	118
-20	1	228	168
-24	1	265	195
-32	1	360	265

Seal-Lok®

Parker's recommended assembly method for Seal-Lok® connections is the torque method.

Dash Size	Swivel Nut Torque		Flats From Wrench Resistance (FFWR)
	Newton Meters (+10% / -0)	Pound Feet (+10% / -0)	
-4	25	18	1/2 - 3/4
-6	40	30	1/2 - 3/4
-8	55	40	1/2 - 3/4
-10	80	60	1/2 - 3/4
-12	115	85	1/3 - 1/2
-16	150	110	1/3 - 1/2
-20	205	150	1/3 - 1/2
-24	315	230	1/3 - 1/2
-32	-	-	-

Note: The assembly torques listed are higher than the test torques published in SAE J1453.

Torque Conversion Equivalents

Torque Conversion Equivalents		
Pound Inch - Pound Foot - Newton Meter		
Pound Foot x 12	=	Pound Inch
Pound Foot x 1.356	=	Newton Meter
Newton Meter x 8.850	=	Pound Inch
Newton Meter x 0.737	=	Pound Foot
Pound Inch x .083	=	Pound Foot
Pound Inch x 0.113	=	Newton Meter

The torque values for other materials are as follows:

- Brass fittings and adapters - 65% of the torque value for steel.
- Stainless steel, and Monel - Use 5% higher than listed for steel. Threads to be lubricated for these materials.
- Dissimilar metals - use torque value designated for the lower of the two metals.
- All fittings are dry except as noted above.

The Flats From Wrench Resistance (FFWR) and torque values listed above are consistent with the values recommended by Parker Tube Fittings Division (614) 279-7070 or www.parker.com/tfd.



Identifying Fitting Types

A

In general fittings can be identified by their visual appearance, their sealing surface/sealing type or by their thread type/form. Viewing the following pages, the visual identification will be self explanatory. The sealing mechanism and the method of thread identification, however, needs further explanation

Determining Sealing Mechanisms:

- Thread interface
- O-ring
- Matching angle or metal-to-metal joint
- Mated angle with O-ring

Thread Interface

The sealing is assured by the flattening of the edges of the threads when the male is screwed into the female fitting. Typically the front of the male fittings is narrower than the back of the fittings – often referred to as tapered threads.

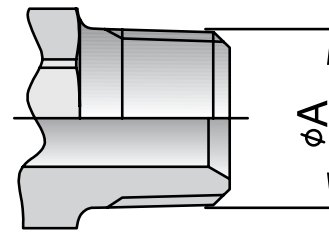

B

O-ring

The O-ring on the male is compressed against the corresponding female and assures the seal. This type of sealing mechanism should be the preferred choice for high-pressure applications.

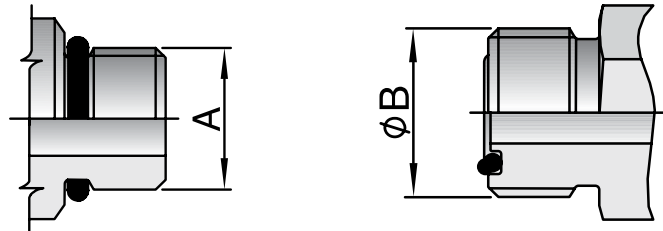

D

Matching Angle or Metal-to-Metal Joint

Sealing takes place where the two angled faces of the male and corresponding female meet and are wedged into one another by the tightening of the threaded nut. The sealing surfaces can either be convex or concave (seat) on the male or in the head of the pipe of the female as shown.

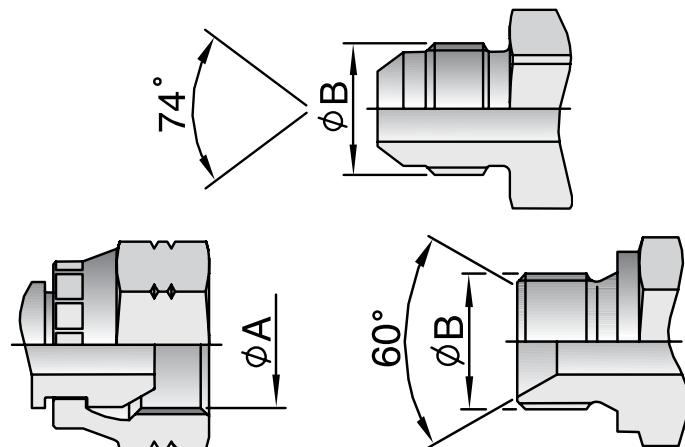

E

Matching Angle with O-ring

These fittings combine the functionality of both the matching angle seal with the O-ring. The O-ring is in the angled sealing surface of the fitting so that when the threaded male and female are screwed together the sealing surfaces wedge together and at the same time deform the O-ring between them.

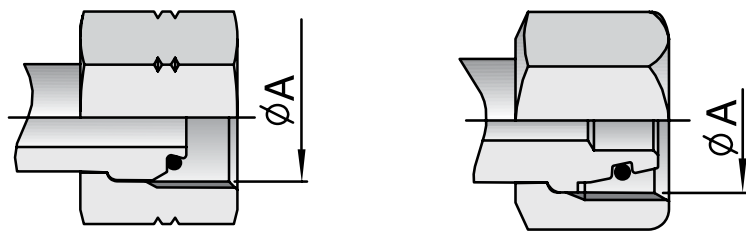

Determining the Thread Type

In general of the threads of various fittings look similar and hinder the easy identification of the thread. To assure the correct identification, the threads must be measured and compared to the tables listed in the following section.

Thread Gauge

Using a thread gauge, the number of threads per inch can be determined.

Holding the gauge and coupling threads in front of a lighted background helps to obtain an accurate measurement.

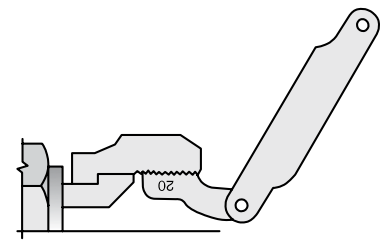
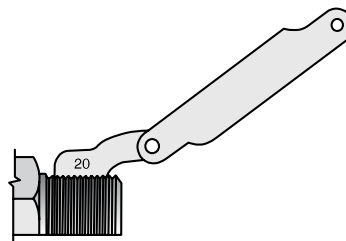

Caliper Measure

A vernier caliper should be used to measure the thread diameter of the largest point. (Outside diameter (O.D.) of male threads – Inside Diameter (I.D.) of female threads.)

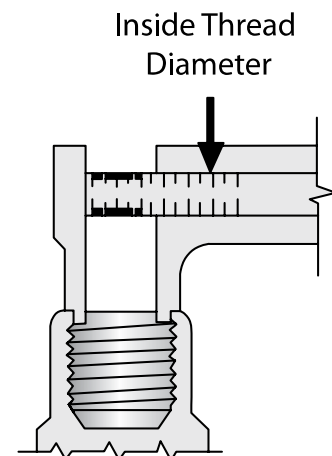
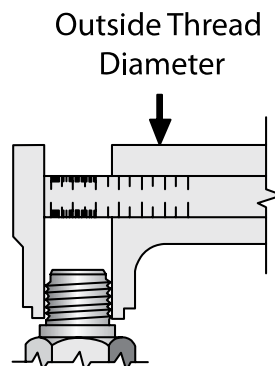

A

B

C

D

E

German DIN Hose Fittings

Often referred to as metric fittings, these fittings seal using the angled sealing surfaces (metal-to-metal) or the combination of metal-to-metal with O-rings.

They are available in very light (LL), light (L) or heavy series (S).

The sealing face angles are either 24° with or without O-rings, or 24°/60° universal cones.

Identification is made by measuring the thread size and also the tube outside diameter.

Defined by the outside diameter and the pitch (distance between 2 crests of the thread) example: M22x1.5 - pitch of 1.5mm.

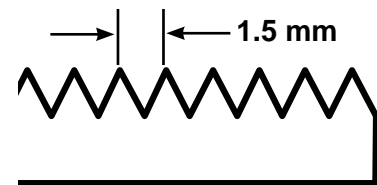

A

DIN Very Light Series (LL)

The male 60° cone will mate with the female 60° cone only.

The male has a 60° sealing angle (seat) and straight metric thread. The female has a 60° seat and straight metric thread.

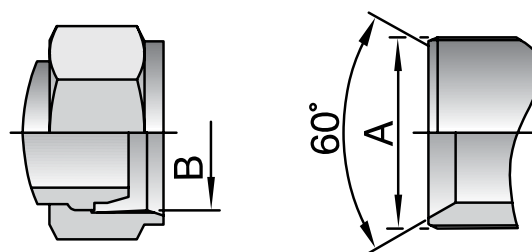

B

Standard

DIN 20078 Part 3 ¹⁾

Parker end configurations
C0

Tube O.D. (DN)	Thread metric	ØA (mm)	ØB (mm)
20	M30x1.5	30.00	28.50
25	M38x1.5	38.00	36.50
32	M45x1.5	45.00	43.50
40	M52x1.5	52.00	50.50
50	M65x2	65.00	63.00

C

DIN Light (L) and Heavy Series (S) without O-ring

The male 24° cone will mate with the female universal 24° or 60° cone only.

The male has a 60° sealing angle (seat) and straight metric threads. The female has a 24° and 60° universal seat and straight metric threads.

D

Standard

DIN 20078 Part 2 ¹⁾

(previously known as DIN 20078 A, D & E)

Parker end configurations
light series

C3, C4, C5, C6

(Often also referred to as “Ball nose cones”)

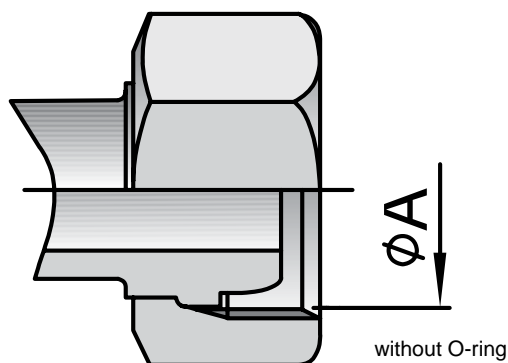

E

¹⁾ obsolete standard, no exact replacement

DIN 24° Light (L) and Heavy Series (S) with O-ring

The male has a 24° sealing angle cone seat with straight metric threads.

The female has a 24° convex cone with O-ring and a swivel straight metric threaded nut.

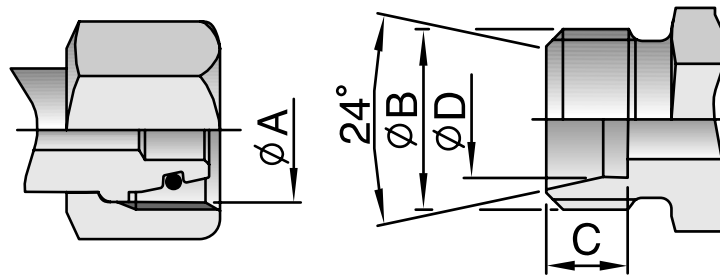

with O-ring

Standard

ISO 12151-2 / ISO 8434-1 & ISO 8434-4

(Previously

DIN 20 078 Part 4, 5, 8, 9)

Parker end configurations light series

CA, CE, CF, D0

Parker end configurations heavy series

C9, 0C, 1C, D2

Tube O.D. (mm)	Spec.	Thread metric	ØA (mm)	ØB (mm)	C (mm)	ØD (mm)
6.00	6L	M12X1.5	10.50	12.00	7.00	6.20
6.00	6S	M14X1.5	12.50	14.00	7.00	6.20
8.00	8L	M14x1.5	12.50	14.00	7.00	8.20
8.00	8S	M16x1.5	14.50	16.00	7.00	8.20
10.00	10L	M16x1.5	14.50	16.00	7.00	10.20
10.00	10S	M18x1.5	16.50	18.00	7.50	10.20
12.00	12L	M18x1.5	16.50	18.00	7.00	12.20
12.00	12S	M20x1.5	18.50	20.00	7.50	12.20
14.00	14S	M22x1.5	20.50	22.00	8.00	14.20
15.00	15L	M22x1.5	20.50	22.00	7.00	15.20
16.00	16S	M24x1.5	22.50	24.00	8.50	16.20
18.00	18L	M26x1.5	24.50	26.00	7.50	18.20
20.00	20S	M30x2	27.90	30.00	10.50	20.20
22.00	22L	M30x2	27.90	30.00	7.50	22.20
25.00	25S	M36x2	33.90	36.00	12.00	25.20
28.00	28L	M36x2	33.90	36.00	7.50	28.20
30.00	30S	M42x2	39.90	42.00	13.50	30.20
35.00	35L	M45x2	42.90	45.00	10.50	35.30
38.00	38S	M52x2	49.90	52.00	16.00	38.30
42.00	42L	M52x2	49.90	52.00	11.00	42.30

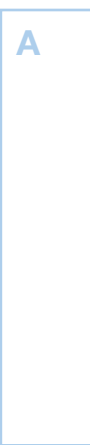

British Standard Pipe (BSP)

Also referred to as Whitworth threads, the BSP thread type fittings seal use metal-to-metal angled surfaces or a combination of metal-to-metal and an O-ring.

The angle of the sealing surfaces is 60° for both forms.

There are two popular thread forms:

British Standard Pipe Parallel (BSPP) and British Standard Pipe Tapered (BSPT).

Identification is made by measuring the outside diameter of the thread and the number of threads per inch (25.4 mm)

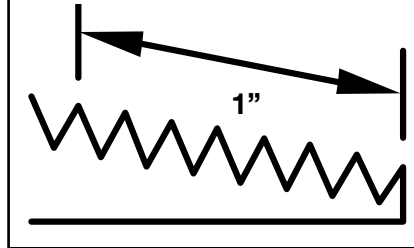

A

BSPP BS5200

Parker end configurations
92, B1, B2, B4, D9

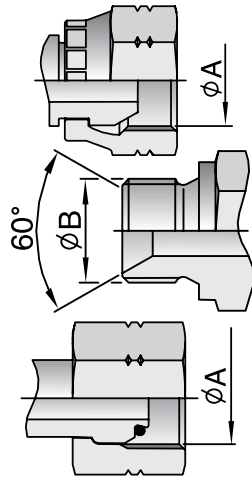

Tube I.D./O.D. (mm)	Size	Thread BSP	ØA (mm)	ØB (mm)
6/10	-2	1/8x28	8.60	9.70
8/13	-4	1/4x19	11.50	13.20
12/17	-6	3/8x19	14.90	16.70
15/21	-8	1/2x14	18.60	20.90
18/23	-10	5/8x14	20.60	22.90
20/27	-12	3/4x14	24.10	26.40
26/34	-16	1x11	30.30	33.20
33/42	-20	1-1/4x11	38.90	41.90
40/49	-24	1-1/2x11	44.90	47.80
50/60	-32	2x11	56.70	59.60

B

BSPP

metal-to-metal with O-ring
Standard
ISO 12151-6

Some Parker end configurations may be non-standard parts.

C

BSPT

fittings seal through the thread interface mechanism. Care should be taken not to confuse the BSPT fitting with the NPTF male fitting. BSPT has a 55° thread angle. NPTF has 60° thread angle.

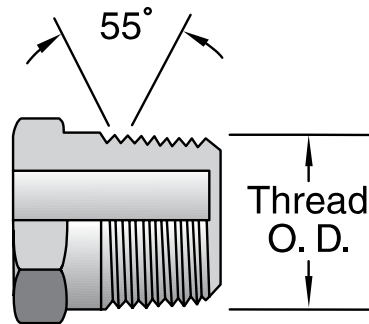

Tube I.D./O.D. (mm)	Size	Thread BSP	ØA (mm)
5/10	-2	1/8x28	9.73
8/13	-4	1/4x19	13.16
12/17	-6	3/8x19	16.66
15/21	-8	1/2x14	20.96
20/27	-12	3/4x14	26.44
26/34	-16	1x11	33.25
33/42	-20	1-1/4x11	41.91
40/49	-24	1-1/2x11	47.80
50/60	-32	2x11	59.61

D

Parker end configuration
91

BSP Flat Seal

These fittings have BSP parallel threads but the sealing surface is flat. The seal is made when the composite seal is compressed against the female flat face.

Some Parker end configurations may be non-standard parts.

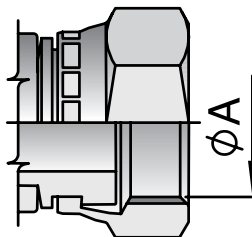

Tube I.D./O.D. (mm)	Size	Thread BSP	ØA (mm)
6/10	-2	1/8x28	8.6
8/13	-4	1/4x19	11.5
12/17	-6	3/8x19	14.9
15/21	-8	1/2x14	18.6
18/23	-10	5/8x14	20.6
20/27	-12	3/4x14	24.1
26/34	-16	1x11	30.3

E

French Gas fittings

Typical to the French market the French Gas fittings have a 24° sealing surfaces seat with metric straight threads. Although similar to German DIN fittings the threads differ in some sizes as the French Gas fittings have fine threads in all sizes whereas the German DIN fittings use standard threads in the larger sizes.

French Metric 24° Cone Gas Fittings

The sealing mechanism is metal-to-metal.

The fittings are not specified in any international standard.

Some Parker end configurations may be non-standard parts.

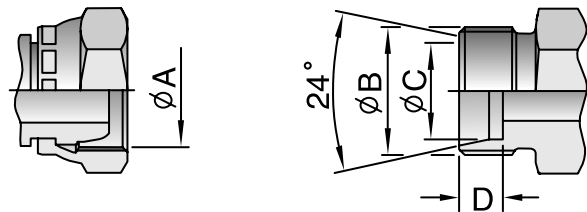

Tube O.D. (mm)	Spec.	Thread metric	ØA (mm)	ØB (mm)	ØC (mm)	D (mm)
6.00	6N	M12x1	11.00	12.00	6.20	9.00
8.00	8N	M14x1.5	12.50	14.00	8.15	9.00
10.00	10N	M16x1.5	14.50	16.00	10.20	9.00
12.00	12N	M18x1.5	16.50	18.00	12.15	9.00
13.25	13G	M20x1.5	18.50	20.00	13.50	9.00
14.00	14N	M20x1.5	18.50	20.00	14.15	9.00
15.00	15N	M22x1.5	20.50	22.00	15.15	9.00
16.00	16N	M24x1.5	22.50	24.00	16.15	9.00
16.75	17G	M24x1.5	22.50	24.00	17.00	9.00
18.00	18N	M27x1.5	25.50	27.00	18.15	9.00
20.00	20N	M27x1.5	25.50	27.00	20.15	9.00
21.25	21G	M30x1.5	28.50	30.00	21.50	9.00
22.00	22N	M30x1.5	28.50	30.00	22.15	9.00
25.00	25N	M33x1.5	31.50	33.00	25.15	9.00
26.75	27G	M36x1.5	34.50	36.00	27.00	9.00
28.00	28N	M36x1.5	34.50	36.00	28.25	9.00
30.00	30N	M39x1.5	37.50	39.00	30.25	9.00
32.00	32N	M42x1.5	40.50	42.00	32.25	9.00
33.25	34G	M45x1.5	43.50	45.00	33.80	9.00
35.00	35N	M45x1.5	43.50	45.00	35.25	9.00
38.00	38N	M48x1.5	46.50	48.00	38.25	9.00
40.00	40N	M52x1.5	50.50	52.00	40.35	9.00
42.25	42G	M52x1.5	50.50	52.00	42.55	9.00
48.25	49G	M58x2	55.90	58.00	49.00	11.00



North American Thread Types

This type of fitting uses the thread interface to seal and as such has a tapered thread that deforms and forms the seal.

They have 30° sealing angle surfaces, forming a 60° inverted (concave) seat. The fittings are most frequently seen on machines of US origin.

A

Dryseal American Standard Taper Pipe Thread (NPTF)

The NPTF male will mate with the NPTF, NPSF, or NPSM females. Care should be taken not to confuse the NPTF fitting with the BSPT male fitting. NPTF fittings have a 60° thread angle. BSPT has a 55° thread angle.

Standard
SAE J516

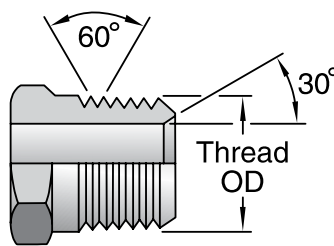

Size	Thread NPTF	ØA (mm)	ØB (mm)
-2	1/8x27	10.24	8.73
-4	1/4x18	13.61	11.90
-6	3/8x18	17.05	15.90
-8	1/2x14	21.22	19.05
-12	3/4x14	26.56	24.60
-16	1x11.5	33.22	30.95
-20	1-1/4x11.5	41.98	39.69
-24	1-1/2x11.5	48.05	45.24
-32	2x11.5	60.09	57.15

ØA dimension is measured on the 4th pitch of the thread

B

Parker end configuration
01

C

SAE JIC 37°

Commonly referred to as JIC fittings, these metal-to-metal sealing type fittings have a 37° flare (sealing surface angle) and straight United National Fine Threads (UNF).

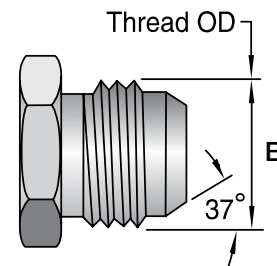
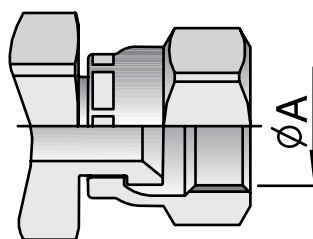

The original design specification for the fittings comes from the Society of Automotive Engineers (SAE) and these fittings are the most common American fitting types in Europe.

Standard

ISO 12151-5, ISO8434-2 and
SAE J516

Parker JIC hose fittings are fully compatible with Parker Triple-Lok Tube Fittings and adapters.

Tube O.D. (inch)	Tube O.D. (mm)	Thread UNF	Size	ØA (mm)	ØB (mm)
3/16		3/8x24	-3	8.60	9.50
1/4	6	7/16x20	-4	10.00	11.10
5/16	8	1/2x20	-5	11.60	12.70
3/8	10	9/16x18	-6	13.00	14.30
1/2	12	3/4x16	-8	17.60	19.10
5/8	14-15-16	7/8x14	-10	20.50	22.20
3/4	18-20	1-1/16x12	-12	24.60	27.00
7/8	22	1-3/16x12	-14	28.30	30.10
1	25	1-5/16x12	-16	31.30	33.30
1-1/4	30-32	1-5/8x12	-20	39.20	41.30
1-1/2	38	1-7/8x12	-24	45.60	47.60
2		2-1/2x12	x32	61.50	63.50

Parker end configurations
03, 06/68, 37/3V, 39/3W, 41/3Y, L9

D

E

SAE 45° Flare

The angle of the flare is commonly used as a name when referring to these metal-to-metal sealing fittings. The female fittings have a 90° concave inverted seat, created by the 45° angle sealing surfaces.

The SAE 45° flare male will mate with an SAE 45° flare female only or a dual seat JIC 37°/SAE45°.

Standard

SAE J516

Parker end configurations

04, 08/68, 77/3V, 79/3W, 81/3Y

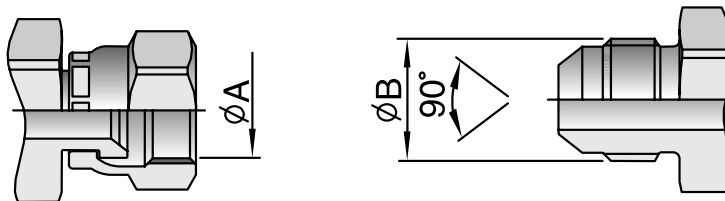

Tube O.D. (inch)	Size	Thread UNF	ØA (mm)	ØB (mm)
1/4	x4	7/16x20	9.90	11.10
5/16	-5	1/2x20	11.50	12.70
3/8	-6	5/8x18	14.30	15.90
1/2	-8	3/4x16	17.50	19.10
5/8	-10	7/8x14	20.60	22.20
3/4	-12	1-1/16x14	25.00	27.00

SAE O-ring (Boss Type)

This male fitting has straight threads, a sealing face and an O-ring. It is compatible only with female boss type fittings generally found in the ports of machines. Sealing is achieved through the O-ring of the male and through the sealing face of the female.

Parker end configuration

05

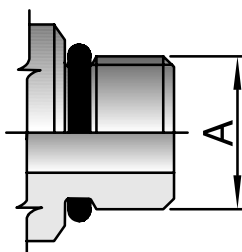

Thread UNF	Size	ØA (mm)
5/16x24	-2	7.93
3/8x24	-3	9.52
7/16x20	-4	11.11
1/2x20	-5	12.70
9/16x18	-6	14.28
3/4x16	-8	19.10
7/8x14	-10	22.22
1-1/16x12	-12	27.00
1-3/16x12	-14	30.10
1-5/16x12	-16	33.30
1-5/8x12	-20	41.30
1-7/8x12	-24	47.60
2-1/2x12	-32	63.50

O-ring Face Seal (ORFS)

ORFS fittings are becoming the most popular international fitting type used on global OEM machines due to their high level of sealing and their good vibration resistance. The fittings use the O-ring compression mechanism to seal.

The female fittings have flat faces and straight threaded UNF swivel nuts.

The male fittings have the O-ring in a groove in the flat face.

Seen as a major advantage, these fittings offer the possibility to build the hose assemblies into fixed distances/spaces, without having to move back other system components due the flat faces of the male and female fittings – the hose assembly can be slotted in.

Standard

ISO 12151-1, ISO8434-3 and SAE J516

Parker end configurations

JC, JM/J0, JS, JU, J1, J3, J5, J7, J9

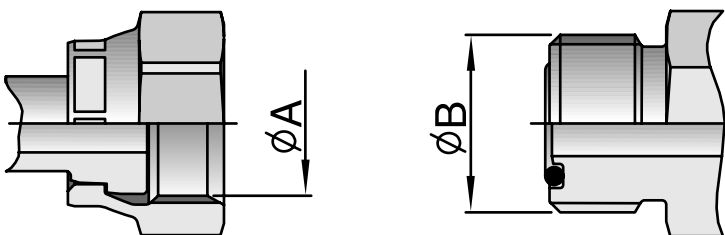

Tube O.D. (inch)	Tube O.D. (mm)	Thread UNF	Size	ØA (mm)	ØB (mm)
1/4	6	9/16x18	-4	13.00	14.20
3/8	10	11/16x16	-6	15.90	17.50
1/2	12	13/16x16	-8	19.10	20.60
5/8	16	1x14	-10	23.80	25.40
3/4	20	1-3/16x12	-12	28.20	30.10
1	25	1-7/16x12	-16	34.15	36.50
1-1/4	32	1-11/16x12	-20	40.50	42.90
1-1/2	38	2x12	-24	48.80	50.80



Flange Fittings
Code 61 and Code 62

The 4-bolt split flange (or full flange) fitting is used worldwide for connecting high-pressure hoses typically to pumps, motors and cylinders, where the hose assemblies are subjected to large pressure loadings. The sealing mechanism is through compression of the O-ring in the face of the flange head against the surface of the port/connection.

The flange fittings are generally separated into two pressure classes referred to as 3000 psi (SFL) or 6000 psi (SFS).

ISO 12151-3 refers to the flange fittings as code 61 for the 3000 psi and code 62 for the 6000 psi. In addition to these flanges, customer-specific Komatsu® and CATERPILLAR® flanges can also be found in the market.

Parker end configurations

Code 61 (3000 psi)

15, 16, 17, 19, P5, P7, P9

5000 psi (Code 61 dimensions)

4A, 4F, 4N

Code 62 (6000 psi)

6A, 6F, 6N, PA, PF, PN, 89

Caterpillar flange

XA, XF, XG, XN

Although not in the SAE or the ISO standard the size -10 (5/8) flange head is gaining popularity. This flange is often found on Komatsu equipment or hydrostatic drives in agricultural machines.

- Standard Code 61 for 3000 to 5000 psi max., depending on size
- High Pressure Code 62 for 6000 psi max. regardless of size

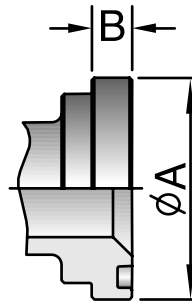

Flange (inch)	Size	Code 61 MPa / psi	Code 62 MPa / psi
1/2	-8	34.5 / 5000	41.3 / 6000
3/4	-12	34.5 / 5000	41.3 / 6000
1	-16	34.5 / 5000	41.3 / 6000
1-1/4	-20	27.5 / 4000	41.3 / 6000
1-1/2	-24	20.7 / 3000	41.3 / 6000
2	-32	20.7 / 3000	41.3 / 6000

Note: 5000 psi in size -20/-24/-32 with 4A, 4F and 4N fittings and 50H flange halves.

Code 61 – SAE – 3000 psi

Flange (inch)	Size	ØA (mm)	B (mm)	O-Ring
1/2	-8	30.18	6.73	18.64x3.53
3/4	-12	38.10	6.73	24.99x3.53
1	-16	44.45	8.00	32.92x3.53
1-1/4	-20	50.80	8.00	37.69x3.53
1-1/2	-24	60.33	8.00	47.22x3.53
2	-32	71.42	9.53	56.74x3.53
2-1/2	-40	84.12	9.53	69.44x3.53
3	-48	101.60	9.53	85.32x3.53

Code 62 – SAE – 6000 psi

Flange (inch)	Size	ØA (mm)	B (mm)	O-Ring
1/2	-8	31.75	7.75	18.64x3.53
3/4	-12	41.28	8.76	24.99x3.53
1	-16	47.63	9.53	32.92x3.53
1-1/4	-20	53.98	10.29	37.69x3.53
1-1/2	-24	63.50	12.57	47.22x3.53
2	-32	79.38	12.57	56.74x3.53

CATERPILLAR®

Flange (inch)	Size	ØA (mm)	B (mm)	O-Ring
3/4	-12	41.28	14.22	25.40x5.00
1	-16	47.63	14.22	31.90x5.00
1-1/4	-20	53.98	14.22	38.20x5.00
1-1/2	-24	63.50	14.22	44.70x5.00

Komatsu®

Flange (inch)	Size	ØA (mm)	B (mm)	O-Ring
5/8	-10	34.25	6.00	21.7x3.5

A

B

C

D

E

4-Bolt Split Flange

A 4-bolt split flange is used to attach the flange fittings to their ports.

- Standard Code 61 for 3000 to 5000 psi max., depending on size
- High Pressure Code 62 for 6000 psi max., regardless of size

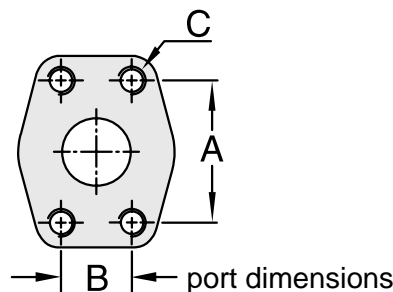

Code 61 – SAE – 3000 psi

Flange (inch)	Size	A (mm)	B (mm)	C	
				(inch)	(metr.)
1/2	-8	38.1	17.5	5/16x18	M8x1.25
3/4	-12	47.6	22.3	3/8x16	M10x1.5
1	-16	52.4	26.2	3/8x16	M10x1.5
1-1/4	-20	58.7	30.2	7/16x14	M10x1.5
1-1/2	-24	69.9	35.7	1/2x13	M12x1.75
2	-32	77.8	42.8	1/2x13	M12x1.75*

Code 62 – SAE – 6000 psi

Flange (inch)	Size	A (mm)	B (mm)	C	
				(inch)	(metr.)
1/2	-8	40.5	18.2	5/16x18	M8x1.25
3/4	-12	50.8	23.8	3/8x16	M10x1.5
1	-16	57.2	27.8	7/16x14	M12x1.75
1-1/4	-20	66.7	31.8	1/2x13	M12x1.75*
1-1/2	-24	79.4	36.5	5/8x11	M16x2
2	-32	96.8	44.4	3/4x10	M20x2.5

*M14x2 still used in the market but no longer in accordance with ISO 6162

Replacing Caterpillar® 6000 PSI Flange Fittings with SAE Code 62 Flange Fittings and Parker “Caterpillar®” Style Flange Fittings

Caterpillar® has a proprietary 6000 PSI hydraulic flange fitting for use on their equipment. This fitting is similar to the SAE Code 62 hydraulic flange (SAE J518). Flange diameters and bolt hole spacing are the same. The Caterpillar® flange head is thicker (.560” in all sizes) and the configuration and location of the O-ring groove is different, requiring the use of a special O-ring.

The Caterpillar® 6000 PSI flange fitting can be replaced with a Parker “Caterpillar®” style flange fitting

such as the 1XA78 using the existing Caterpillar® flange halves and bolts. In this case the XARG O-ring would be used. The fitting could also be replaced with a standard Code 62 flange fitting such as the 16A78. In this case use HFH flange halves or the HFHFHK kit with the standard SAE O-ring (711510).

Do not use the Caterpillar® 6000 PSI split flange halves on SAE Code 62 flange fittings or SAE Code 62 flange halves on Caterpillar® 6000 PSI flange fittings.

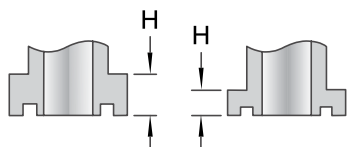

Size	H (in)	H (in)	
		Caterpillar®	SAE Code 62
3/4	(-12)	.560	.345
1	(-16)	.560	.375
1-1/4	(-20)	.560	.405
1-1/2	(-24)	.560	.495

Procedure	P-ring P/N	Flange Half P/N	Flange Kit P/N
When replacing Caterpillar® 6000 PSI Flange Fittings with Parker “Caterpillar® Style” Fittings:	XARG-Size	Use existing flange halves and bolts	Use existing flange halves and bolts
When replacing Caterpillar® 6000 PSI Flange Fittings with SAE Code 61 Flange Fittings:	711510*	HFH-Size	HFHFHK-Size

Japanese fittings

The Japanese Industrial Standard (JIS) is seen on most Japanese equipment and uses a 30° sealing angle seat and either British Standard Pipe Parallel or metric threads.

Care must be taken not to confuse the JIS fittings with BSP or JIC fittings.

Japanese fittings - JIS

The sealing mechanism of the fittings is the 30° metal-to-metal angled surfaces

Parker end configurations

MU, XU (Metric)

FU (BSP)

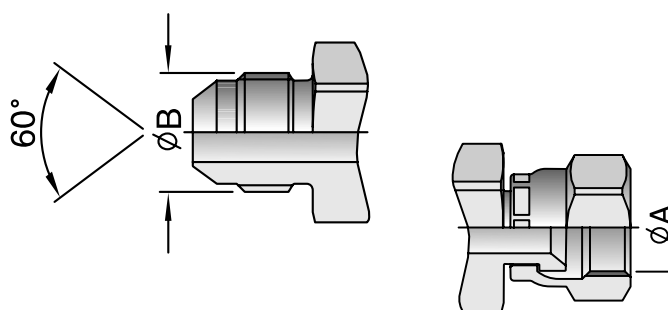

JIS 30° metric









Symbol	Thread metric	ØA (mm)	ØB (mm)
MU-6	M14x1.5	12.50	14.00
MU-9	M18x1.5	16.50	18.00
MU-12	M22x1.5	20.50	22.00
MU-15	M27x2	25.00	27.00
MU-19	M27x2	25.00	27.00
MU-25	M33x2	31.00	33.00
MU-32	M42x2	40.00	42.00
MU-38	M50x2	48.00	50.00
MU-50	M60x2	58.00	60.00









JIS 30° BSP

Symbol	Thread BSP	ØA (mm)	ØB (mm)
GUI-3	1/8x28	8.60	9.70
GUI-5/-6	1/4x19	11.50	13.20
GUI-8/-9	3/8x19	14.90	16.70
GUI-12	1/2x14	18.60	20.90
GUI-15/-19	3/4x14	24.10	26.40
GUI-25	1x11	30.30	33.20
GUI-32	1-1/4x11	38.90	41.90
GUI-38	1-1/2x11	44.90	47.80
GUI-50	2x11	56.70	59.60

A Application

Thread Guide

								
size	NPTF Pipe Thread Size	SAE (JIC) 37 Flare Thread Size	SAE 45 Flare Thread Size	O-Ring Style Straight Thread Size	SAE Inverted Flare Thread Size	PTT 30 Flare Thread Size	SAE Flare-less Thread Size	Seal-Lok Thread
2	1/8 - 27	5/16 - 24	5/16 - 24	5/16 - 24	-	-	5/16 - 24	-
3	-	3/8 - 24	3/8 - 24	3/8 - 24	-	-	3/8 - 24	-
4	1/4 - 18	7/16 - 20	7/16 - 20	7/16 - 20	7/16 - 24	-	7/16 - 20	9/16 - 18
5	-	1/2 - 20	1/2 - 20	1/2 - 20	1/2 - 20	-	1/2 - 20	-
6	3/8 - 18	9/16 - 18	5/8 - 18	9/16 - 18	5/8 - 18	-	9/16 - 18	11/16-16
8	1/2 - 14	3/4 - 16	3/4 - 16	3/4 - 16	3/4 - 18	-	3/4 - 16	13/16 - 16
10	-	7/8 - 14	7/8 - 14	7/8 - 14	7/8 - 18	-	7/8 - 14	1 - 14
12	3/4 - 14	1 1/16 - 12	1 1/6 - 14	1 1/16 - 12	-	-	1 1/16 - 12	1 3/16 - 12
14	-	1 3/16 - 12	-	1 3/16 - 12	-	-	1 3/16 - 12	-
16	1 - 11 1/2	1 5/16 - 12	-	1 5/16 - 12	-	1 5/16 - 14	1 5/16 - 12	1 7/16 - 12
20	1 1/4 - 11 1/2	1 5/8 - 12	-	1 5/8 - 12	-	1 5/8 - 14	1 5/8 - 12	1 11/16 - 12
24	1 1/2 - 11 1/2	1 7/8 - 12	-	1 7/8 - 12	-	1 7/8 - 14	1 7/8 - 12	2-12
32	2 - 11 1/2	2 1/2 - 12	-	2 1/2 - 12	-	2 1/2 - 12	2 1/2 - 12	-

									
Fitting Size	DIN "L" Swivel Female Thread Size	DIN "S" Swivel Female Thread Size	DIN "L" Male Stud Thread Size	DIN "S" Male Stud Thread Size	Male BSPP Thread Size	BSP Swivel Female Thread Size	French Swivel Female Gaz Series	French Swivel Female Metric Series	French Male Stud Metric Series
4	-	-	-	-	1/4x19	1/4x19	--	-	-
6	M12x1,5	M14x1,5	M12x1,5	M14x1,5	3/8x19	3/8x19	-	-	M12x1
8	M14x1,5	M16x1,5	M14x1,5	M16x1,5	1/2x14	1/2x14	-	-	M14x1,5
10	M16x1,5	M18x1,5	M16x1,5	M18x1,5	5/8x14	5/8x14	-	-	M16x1,5
12	M18x1,5	M20x1,5	M18x1,5	M20x1,5	3/4x14	3/4x14	-	-	M18x1,5
-	-	-	-	-	-	-	M20x1,5	-	-
14	-	M22x1,5	-	M22x1,5	-	-	-	-	M20x1,5
15	M22x1,5	-	M22x1,5	-	-	-	-	-	M22x1,5
16	-	M24x1,5	-	M24x1,5	1x11	1x 11	-	-	M24x1,5
-	-	-	-	-	-	-	M24x1,5	-	-
18	M26x1,5	-	M26x1,5	-	-	-	-	-	M27x1,5
20	-	M30x2	-	M30x2	1 1/4x11	1 1/4x11	-	-	M27x1,5
-	-	-	-	-	-	-	M30x 1,5	-	-
22	M30x2	-	M30x2	-	-	-	-	-	M30x1,5
25	-	M36x2	-	M36x2	1 1/2x11	1 1/2x11	-	-	M33x1,5
-	-	-	-	-	-	-	M36x1,5	-	-
28	M36x2	-	M36x2	-	-	-	-	-	M36x1,5
30	-	M42x2	-	M42x2	2x11	2x11	-	-	M39x1,5
33	-	-	-	-	-	-	M45x1,5	-	-

A

B

C

D

E

A Application

Standard Fitting Configurations by Connection and End Code

A

B

C

D

E

	Description	End Code
Pipe	Male NPTF Pipe - Rigid - Straight	01
	Male NPTF Pipe - Swivel - Straight	13
	Male NPTF Pipe - Swivel - 90° Elbow	1L
	Male API Pipe - Rigid - Straight	AP
	Female NPTF Pipe - Rigid - Straight	02
	Female NPSM Pipe - Swivel - Straight (60° Cone)	07
	Female NPTF Pipe - Swivel - Straight	S2
	Female NPSM Pipe - Gasket Joint - Swivel - Straight	7G
	Female Grease Connection - SPL-PTF Taper Thread - Rigid Straight - ½ x 27	GJ
	Male NPTF Pipe - Rigid - 45° Elbow	31
Male NPTF Pipe - Rigid - 90° Elbow or Side Outlet	21	
SAE Str. Ttd.	Male SAE Straight Thread with O-Ring - Rigid - Straight	05
	Male SAE Straight Thread with O-Ring - Swivel - Straight	0G
	Male SAE Straight Thread with O-Ring - Adjustable - 45° Elbow	25
	Male SAE Straight Thread with O-Ring - Swivel - 90° Elbow	0L
Flare	Male SAE Straight Thread with O-Ring - Adjustable - 90° Elbow	35
	Male JIC 37° - Rigid - Straight	03
	Male JIC 37° - Bulkhead without Locknut - Straight	LB
	Female JIC 37° - Swivel - Straight	06
	Female JIC 37° - Swivel - 45° Elbow - Short Drop	37
	Female JIC 37° - Swivel - 45° Elbow - Medium Drop	L7
	Female JIC 37° - Swivel - 90° Elbow - Short Drop	39
	Female JIC 37° - Swivel - 90° Elbow - Medium Drop	L9
	Female JIC 37° - Swivel - 90° Elbow - Long Drop	41
	Female JIC 37° - Swivel - Straight	48
	Female JIC 37° - Swivel - 150° Elbow	4V
	Male SAE 45° - Rigid - Straight	04
	Female SAE 45° - Swivel - Straight	08
	Female SAE 45 / Swivel - 45° Elbow	77
	Female SAE 45 / Swivel - 90° Elbow	79
	Inverted Flare	Female SAE 45 / Swivel - 90° Elbow - Long Drop
Female JIC 37°/SAE 45° Dual Flare - Swivel - Straight		68
Male Inverted SAE 45° - Swivel - Straight		28
Male Inverted SAE 45° - Swivel - 45° Elbow		67
Male Inverted SAE 45° - Swivel - 90° Elbow		69
Male Inverted SAE 45° - Swivel - 90° Elbow - Long (In-Line)		71
Female Inverted SAE 45° - Rigid - Straight		29
Tube-O	Male Tube-O - Swivel - Straight - Short Pilot	S5
	Male Tube-O - Swivel - Straight - Short Pilot with Charge Port for R12	S5-PR
	Male Tube-O - Swivel - Straight - Long Pilot	45
	Male Tube-O - Swivel - Straight - Long Pilot with Charge Port for R12	45-PR

	Description	End Code
Tube-O	Male Tube-O - Swivel - Straight - Long Pilot with Charge Port for R134a	45-PT
	Female Tube-O - Swivel - 90° Elbow - Long Pilot	5L
	Female Tube-O - Swivel - 90° Elbow - Long Pilot with Charge Port for R12	5L-PB
	Female Tube-O - Swivel - 90° Elbow - Long Pilot with Charge Port for R12	5L-PR
	Female Tube-O - Swivel - 90° Elbow - Long Pilot with Charge Port for R134a	5L-PT
	Male Tube-O - Swivel - 90° Elbow - Long Pilot	5M
	Male Tube-O - Swivel - 90° Elbow - Long Pilot with Charge Port for R12	5M-PR
	Male Tube-O - Swivel - 90° Elbow - Long Pilot with Charge Port for R134a	5M-PT
	Male Tube-O - Swivel - 90° Elbow - Long Pilot with Charge Port for R134a	5M-PV
	Male Tube-O - Rigid - Straight - Internal Long Pilot (3-Step)	5G
	Male Tube-O - Rigid - Straight - Internal Long Pilot (3-Step) with Charge Port for R12	5G-PR
	Male Tube-O - Swivel - 45° Elbow - Short Pilot	5R
	Male Tube-O - Swivel - 45° Elbow - Long Pilot	5P
	Male Tube-O - Swivel - 45° Elbow - Long Pilot with Charge Port for R134a	5P-PT
	Male Tube-O - Swivel - 90° Elbow - Short Pilot	5K
	Male Tube-O - Swivel - 90° Elbow - Short Pilot with Charge Port for R134a	5K-PB
	Male Tube-O - Swivel - 90° Elbow - Short Pilot with Charge Port for R12	5K-PR
	Female Tube-O - Swivel - Straight - Short Pilot	5S
	Female Tube-O - Swivel - Straight - Long Pilot	59
Female Tube-O - Swivel - Straight - Long Pilot with Charge Port for 134a	59-PB	
Female Tube-O - Swivel - Straight - Long Pilot with Charge Port	59-PT	
Female Tube-O - Swivel - 45° Elbow - Short Pilot	5H	
Female Tube-O - Swivel - 45° Elbow - Long Pilot	5N	
Female Tube-O - Swivel - 45° Elbow - Long Pilot with Charge Port	5N-PB	
Female Tube-O - Swivel - 45° Elbow - Long Pilot with Charge Port	5N-PT	
Female Tube-O - Swivel - 90° Elbow - Short Pilot	5T	
Compressor	Female Compressor - Swivel - 45° Elbow	5V
	Female Compressor - Swivel - 90° Elbow	5W
	Female Compressor - Swivel - 90° Elbow - Block Type	5Z
	Female Compressor - Swivel - 135° Elbow	RV
	Female Compressor - Swivel - 180° Elbow - Block Type	RZ
Flange	Two Hole (2.25" X 0.44") Flange - Rigid - 90° Elbow	2H
	SAE Code 61 Flange Head - Straight	15
	SAE Code 61 Flange Head - Straight (5,000 psi)	4A
	SAE Code 61 Flange Head - 22½° Elbow -	16

Continued on next page

A Application

Continued from previous page

	Description	End Code
Flange	SAE Code 61 Flange Head-30° Elbow	26
	SAE Code 61 Flange Head-45° Elbow	17
	SAE Code 61 Flange Head-45° Elbow (5,000 psi)	4F
	SAE Code 61 Flange Head-60° Elbow	27
	SAE Code 61 Flange Head - 67½° Elbow	18
	SAE Code 61 Flange Head - 90° Elbow	19
	SAE Code 61 Flange Head - 90° Elbow - (5,000 psi)	4N
	SAE Code 61 Flange Head - 90° Elbow - Long Drop	89
	SAE Code 61 Flange Head - 110° Elbow	2U
	SAE Code 62 Flange Head - Straight	6A
	SAE Code 62 Flange Head - 22½° Elbow	6B
	SAE Code 62 Flange Head - 30° Elbow	6E
	SAE Code 62 Flange Head - 45° Elbow	6F
	SAE Code 62 Flange Head - 60° Elbow	6G
	SAE Code 62 Flange Head - 90° Elbow	6N
Seal-Lok	Caterpillar® Flange Head - Straight	XA
	Caterpillar® Flange Head - 22½° Elbow	XB
	Caterpillar® Flange Head - 30° Elbow	XE
	Caterpillar® Flange Head - 45° Elbow	XF
	Caterpillar® Flange Head - 60° Elbow	XG
	Caterpillar® Flange Head - 67½° Elbow	XM
	Caterpillar® Flange Head - 90° Elbow	XN
	Male Seal-Lok - Rigid - Straight (with O-Ring)	J0
	Male Seal-Lok - Bulkhead without Locknut - Straight (with O-Ring)	JB
	Female Seal-Lok - Swivel - Straight - Long	JS
	Female Seal-Lok - Swivel - Straight - Short	JC
	Female Seal-Lok - Swivel - 221/2° Elbow	J6
	Female Seal-Lok - Swivel - 45° Elbow	J7
	Female Seal-Lok - Swivel - 90° Elbow - Short Drop	J9
	Female Seal-Lok - Swivel - 90° Elbow - Medium Drop	J5
Female Seal-Lok - Swivel - 90° Elbow - Long Drop	J1	
Metric	Female Metric Swivel - Straight (30° Flare)	MU
	Female Metric - Swivel - Straight (30° Flare)	XU
	Male Metric L - Rigid - Straight (24° Cone)	D0
	Male Standpipe Metric L - Rigid - Straight	1D
	Female Metric - Swivel - Straight (Ball Nose)	C0
	Female Metric L - Swivel - Straight (Ball Nose)	C3
	Female Metric L - Swivel - 45° Elbow (Ball Nose)	C4

Standard Fitting Configurations by Connection and End Code

	Description	End Code
Metric	Female Metric L - Swivel - 90° Elbow (Ball Nose)	C5
	Female Metric L - Swivel - Straight (24° Cone with O-Ring)	CA
	Female Metric L - Swivel - 45° Elbow (24° Cone with O-Ring) -	CE
	Female Metric L - Swivel - 90° Elbow (24° Cone with O-Ring) -	CF
	Male Metric S - Rigid - Straight (24° Cone)	D2
	Male Standpipe Metric S - Rigid - Straight	3D
	Female Metric S - Swivel - Straight (Ball Nose)	C6
	Female Metric S - Swivel - 45° Elbow (Ball Nose)	C7
	Female Metric S - Swivel - 90° Elbow (Ball Nose)	C8
	Female Metric S - Swivel - Straight (24° Cone with O-Ring)	C9
BSP	Female Metric S - Swivel - 45° Elbow (24° Cone with O-Ring)	0C
	Female Metric S - Swivel - 90° Elbow (24° Cone with O-Ring)	1C
	Male BSP Taper Pipe - Rigid - Straight	91
	Female BSP Parallel Pipe - Swivel - Straight (60° Cone)	92
	Male BSP Parallel Pipe - Rigid - Straight (60° Cone)	D9
	Female BSP Parallel Pipe - Swivel - 45° Elbow (60° Cone)	B1
	Female BSP Parallel Pipe - Swivel - 90° Elbow (60° Cone)	B2
	Female BSP Parallel Pipe - Swivel - 90° Elbow Block Type (60° Cone)	B4
	Female BSP Parallel Pipe - Swivel - Straight (Flat Seat)	B5
	Male BSP Taper Pipe - Rigid - 45° Elbow	BV
Fr. Gaz	Male BSP Taper Pipe - Rigid - 90° Elbow or Side Outlet	BZ
	Female BSP Parallel Pipe - Swivel - Straight (30° Flare)	FU
	Male BSP Taper Pipe - Rigid - Straight (60° Cone)	UT
	Female BSP Parallel Pipe - Swivel - Straight (60° Cone)	GU
	Female BSP Parallel Pipe - Swivel - 45° Elbow (60° Cone)	G1
	Female BSP Parallel Pipe - Swivel - 90° Elbow (60° Cone)	G2
	Male French Gaz Series - Rigid - Straight (24° Cone)	FG
	Female French Gaz Series - Swivel - Straight (Ball Nose)	F4
	DIN Metric Banjo - Straight	49
	88 Series Heavy Duty Hose Clamp (Double Bolt Hose Clamp)	88DB
Specialty	88 Series Hose Clamp- <i>SAE 100R4 Two-Bolt Clamp</i>	88HC-H
	88 Series Hose Clamp (Worm Gear)	88HC
	Push-Lok Union	82
	Hose Splicer	88
	Male Standpipe - Rigid - Straight (Inch Size Tube O.D.)	34
	Male Ferulok Flareless-Rigid-Straight (24° Cone with Nut and Ferrule)	11
	Female Ferulok Flareless - Swivel - Straight (24° Cone)	12
	Female Air Brake Jounce Line - Swivel - Straight	7B
	Male Refrigerant Tube Mender - Straight (with Nut and Ferrule)	T1
	Female PTT 30° - Swivel	32
Male SAE Compression Seat (without Nut or Sleeve)	61	

A

B

C

D

E

A Application

Metric Conversion

A

METRIC to ENGLISH EQUIVALENTS ENGLISH to METRIC EQUIVALENTS

inches x 25.4 = millimeters (mm)
 inches x 2.54 = centimeters (cm)
 feet x .3048 = meters (m)
 yard x .9144 = meters (m)
 psi x .0689 = bar
 psi x .0069 = Megapascals (MPa)
 psi x .0703 = Kilogram force per square centimeter (Kgf/cm²)
 pound force x 4.448 = Newtons
 pound · inch x .113 = Newton · meters (N · m)
 pound · foot x 1.356 = Newton · meters (N · m)
 millimeter x .0394 = inch (in)
 centimeter x .3937 = inch (in)
 meters ÷ 3.281 = feet (ft)
 meters x 1.0936 = yards (yd)
 bar x 14.5 = psi
 Megapascals x 145.0 = psi
 Kilogram force per square centimeter x 14.22 = psi
 Newtons x .2248 = pounds force (lbf)
 Newton · meter x 8.850 = pound · inches (lb · in)
 Newton · meter x .737 = pound feet (lb · ft)

B

C

D

E

METRIC I.D. KIT

INTERNATIONAL HOSE FITTING IDENTIFICATION KIT

The booklet, gauges and caliper contained in this fitting I.D. Kit, can be used to identify most types of hydraulic hose fittings and adapters including:

- U.S. Standards
- British Standard Pipe
- German (DIN) Metric
- French Metric and GAZ
- Japanese Standards (JIS)

Contents of Kit:

- Instruction Book with Tables
- Screw Pitch Gauge for U.S. Threads
- International Gauge for Metric and British Threads
- Inch and Millimeter Caliper
- Carry Case

For information, contact your local distributor or the Parker Catalog Service Department - 1-800-272-7537 or 1-614-279-7070.

MILLIMETERS to FRACTIONS to DECIMALS

MM	INCHES		MM	INCHES		MM	INCHES		MM	INCHES	
	FRACTION	DECIMAL		FRACTION	DECIMAL		FRACTION	DECIMAL		FRACTION	DECIMAL
0.3969	1/64	0.0156	6.7469	17/64	0.2656	13.0969	33/64	0.5156	19.4469	49/64	0.7656
0.7938	1/32	0.0312	7.1438	9/32	0.2812	13.4938	17/32	0.5312	19.8438	25/32	0.7812
1.1906	3/64	0.0468	7.5406	19/64	0.2968	13.8906	35/64	0.5468	20.2406	51/64	0.7968
1.5875	1/16	0.0625	7.9375	5/16	0.3125	14.2875	9/16	0.5625	20.2375	13/16	0.8125
1.9844	5/64	0.0781	8.3344	21/64	0.3281	14.6844	37/64	0.5781	21.0344	53/64	0.8281
2.3812	3/32	0.0937	8.7312	11/32	0.3437	15.0812	19/32	0.5937	21.4312	27/32	0.8437
2.7781	7/64	0.1093	9.1281	23/64	0.3593	15.4781	39/64	0.6093	21.8281	55/64	0.8593
3.1750	1/8	0.1250	9.5250	3/8	0.3750	15.8750	5/8	0.6250	22.2250	7/8	0.8750
3.5719	9/64	0.1406	9.9219	25/64	0.3906	16.2719	41/64	0.6406	22.6219	57/64	0.8906
3.9688	5/32	0.1562	10.3188	13/32	0.4062	16.6688	21/32	0.6562	23.0188	29/32	0.9062
4.3656	11/64	0.1718	10.7156	27/64	0.4218	17.0656	43/64	0.6718	23.4156	59/64	0.9218
4.7625	3/16	0.1875	11.1125	7/16	0.4375	17.4625	11/16	0.6875	23.8125	15/16	0.9375
5.1594	13/64	0.2031	11.5094	29/64	0.4531	17.8594	45/64	0.7031	24.2094	61/64	0.9531
5.5562	7/32	0.2187	11.9062	15/32	0.4687	18.2562	23/32	0.7187	24.6062	31/32	0.9687
5.9531	15/64	0.2343	12.3031	31/64	0.4843	18.6531	47/64	0.7343	25.0031	63/64	0.9843
6.3500	1/4	0.2500	12.7000	1/2	0.5000	19.0500	3/4	0.7500	25.4000	1	1.0000



Chemical Resistance Information

Warning: This chemical compatibility guide must not be used in conjunction with any other compatibility guides from previous or future catalog editions, bulletins or publications. Incorrect use of these charts could result in death, personal injury or property damage.

Hose Selection by Medium and Hose Type

This hose compatibility chart is a ready reference of Parker hose compatibility with various fluid media. It is intended as a guide to chemical compatibility with inner tube materials and assembly lubricant applied internally. The specific recommendations are based upon field experience, the advice of various polymer or fluid suppliers, and specific laboratory experiments. **It must be stressed, however, that this information is offered only as a guide.** Final hose selection depends also upon pressure, fluid temperature, ambient temperature, and special requirements or variations, which may not be known by Parker Hannifin. Legal and other regulations must be followed with particular care. Where an external compatibility problem may occur, or for fluids not listed, we encourage you to first contact the fluid manufacturer for a recommendation prior to contacting your Parker Hannifin Field Representative or the Technical Service Department, Hose Products Division, Wickliffe, Ohio.

Use the Chart as Follows:

1. Locate medium to be carried using the Chemical Resistance Table on the following pages.
2. Select suitability of hose and fitting material from the table based on the letter rating in the table. See resistance rating key below for explanation of compatibility ratings. See list of numerals below for an explanation when a numeral, or a numeral and a letter rating are present in the table.
3. The Column headings on the Chemical Resistance Table, I, II, III, IV, V, refer to specific groups of hoses.
4. Locate hose part number under Column I, II, III, IV, V from the list below.
5. For fitting material availability refer to appropriate fitting section of catalog.
6. Check hose specifications in this catalog. Contact Hose Division Technical Service Department on any items not cataloged.

Resistance Rating Key

A = Preferred, good to excellent with little or no change in physical properties.

F = Fair, marginal or conditional with noticeable affects on physical properties.

X = Unsuitable, severe affects on physical properties.

~ = No rating, insufficient information.

Note: All data based on 70°F unless otherwise noted.

Please visit www.Parkerhose.com for the latest information.

Numerals

1. For air or gaseous applications above 250 PSI (1,7 MPa), the cover should be pin pricked. The service life for air or gaseous applications can be unpredictable, especially at higher pressures. Contact Technical Service Department for more information.
2. Legal and insurance regulations must be considered. Contact Technical Service Department for more information.
3. Push-Lok hoses 801 and 836 are approved for diesel fuel applications only when coupled with HY series fittings.
4. Use 285, 235 or 244 hoses. The compatibility of the systems refrigeration oil with these hoses needs to be evaluated on a case by case basis. Contact HPD Technical Service Department for more information. Do not use mineral oil or Alkyl Benzene refrigeration oils with 244 hose. Chemical compatibility does not imply low permeation.
5. 150°F (65°C) maximum.
6. Satisfactory at some concentrations and temperatures, unsatisfactory at others.
7. For phosphate ester fluids use 304, 424, 774, F42 or 804 hoses.
8. Acceptable for flushing hose assemblies.
9. 221FR hose recommended.
10. For dry air applications, hoses with inner tubes from columns IV, and V are preferred. See hose specifications for maximum recommended temperatures with air.
11. Use SS23CG or SS25UL
12. Use SS23CG

Hose Types

Column I

AX, BXX, P35, 201, 341, 601, 701, 711 721, 721TC, 721ST, 731, 761, 781, 791TC, 881

Column II

SS25UL, 301LT, 351TC, 351ST, 421WC, 431, 451TC, 451ST, 471TC, 471ST, 472LT, 722LT, 772LT, 792LT, 801, 811, 811HT

Column III

JK, 221FR, 302, 422, 472TC, 482TC, 482ST, 722TC, 772TC, 772ST, 782TC, 782ST, 787TC, 792TC, 792ST, 797TC, 821

Column IV

206, 213, 266, 293, 426, 611HT, 821FR, 836, 436

Column V

F42, 304, 424, 774, 804

Caution:

The fluid manufacturer's recommended maximum operating temperature for any specific name-brand fluid should be closely observed by the user. Specific name brand fluids can vary greatly between manufacturers even though they are considered to be from the same family or type of fluids. Using fluids above the manufacturers maximum recommended temperature can cause the fluid to break down, creating by-products that can be harmful to elastomers or other materials used in the system. When selecting a hose type, both the fluid manufacturer and hose manufacturers maximum temperature limit must be taken into consideration, with the lower of the two taking precedence.

A

B

C

D

E

Media

Chemical Resistance Information (Page 1 of 9)

Warning: This chemical compatibility guide must not be used in conjunction with any other compatibility guides from previous or future catalog editions, bulletins or publications. Incorrect use of these charts could result in death, personal injury or property damage.

MEDIA	I	II	III	IV	V	Steel	Brass	SS
3M FC-75	A	A	A	A	A	A	A	A
Acetic Acid	X	X	X	A	6	X	X	A
Acetone	X	X	X	A	A	A	A	A
Acetylene	X	X	X	X	X	~	~	~
Aeroshell 31	F	A	A	F	~	A	A	A
AEROSHELL Turbine Oil 500	X	X	F	X	X	A	A	A
Air	A,1,10	A,1,10	A,1,10	A,1,10	A,1,10	A	A	A
Air (dry)	X	F,1,10	F,1,10	A,1,10	A,1,10	A	A	A
Alcohol (Methanol-Ethanol)	F	F	F	F	F	F	A	A
Americas Choice AW ISO 46	~	F	F	~	~	~	~	~
Ammonia (Anhydrous)	X	X	X	X	X	X	X	X
Ammonium Chloride	A	A	A	A	A	X	X	X
Ammonium Hydroxide	F	F	F	A	A	F	X	A
Ammonium Nitrate	A	A	A	F	A	F	X	A
Ammonium Phosphate	A	A	A	A	A	X	X	F
Ammonium Sulfate	A	A	A	A	A	F	X	F
Amoco 32 Rykon	X	A	A	F	X	A	A	A
Ampol PE 46	X	X	X	X	A,7	A	A	A
AMSOIL Synthetic ATF	F	A	A	A	X	A	A	A
Amyl Alcohol	X	X	X	F	F	X	A	A
Anderol 495,497,500,750	X	X	X	F	X	A	A	A
Aniline	X	X	X	F	A	A	X	A
Animal Fats	X	F	F	F	F	6	6	A
Aquacent Light, Heavy	X	A	A	X	X	A	A	A
Aries/Athena	F	F	F	~	X	A	A	A
Aromatic 100,150	X	F	F	~	X	A	A	A
Arrow 602P	A	A	A	A	X	A	A	A
Asphalt	X	F	F	F	X	F	F	A
ASTM #3 Oil	F	F	F	F	X	A	A	A
Astrol 1044AW	A	A	A	~	X	A	A	A
ATF-M	F	A	A	A	X	A	A	A
Automotive Brake Fluid	X	X	X	X	~	X	X	X
AW 32,46,68	F	A	A	A	X	A	A	A
BCF	F	F	F	F	~	A	A	A
Benz Petraulic 32,46,68,100,150,220,320,460	F	A	A	A	X	A	A	A
Benzene, Benzol	X	X	X	F	X	A	A	A
Benzgrind HP 15	~	A	A	A	X	A	A	A
Benzine	X	X	X	F	X	A	A	A
Bio Diesel B20	~	A	A	A	X	A	A	A
Bio-Soy, Agri Industries	X	A	A	X	X	A	A	A
Biodegradable Hydraulic Fluid 112B	X	A	A	X	~	A	A	A
Borax	F	F	F	F	A	F	A	A
Boric Acid	A	A	A	X	A	X	6	A
Brayco 882	X	A	A	A	X	A	A	A

A

B

C

D

E

Media

Chemical Resistance Information (Page 2 of 9)

Warning: This chemical compatibility guide must not be used in conjunction with any other compatibility guides from previous or future catalog editions, bulletins or publications. Incorrect use of these charts could result in death, personal injury or property damage.

MEDIA	I	II	III	IV	V	Steel	Brass	SS
Brayco Micronic 745	~	A	A	F	X	A	A	A
Brayco Micronic 776RP	F	A	A	F	X	A	A	A
Brayco Micronic 889	X	F	F	~	X	A	A	A
Brine	F	F	F	A	A	X	F	F
Butane			See numerals 2 and 11			A	A	A
Butyl Alcohol, Butanol	F	F	F	F	F	F	F	A
Calcium Chloride	A	A	A	F	A	F	F	X
Calcium Hydroxide	A	A	A	A	A	A	A	A
Calcium Hypochlorite	X	X	X	A	A	X	F	X
Calibrating Fluid	A	A	A	A	X	A	A	A
Carbon Dioxide, gas	F	F	F	F	6	A	A	A
Carbon Dioxide, liquid	X	X	X	X	X	X	X	X
Carbon Disulfide	X	X	X	F	X	A	F	A
Carbon Monoxide (hot)	F	F	F	F	6	F	6	A
Carbon Tetrachloride	X	X	X	F	X	6	6	6
Carbonic Acid	F	F	F	X	F	X	X	F
Castor Oil	A	A	A	A	A	A	A	A
Castrol 5000	X	F	F	A	X	A	A	A
Cellosolve Acetate	X	X	X	X	A	X	X	A
Cellugard	A	A	A	~	A	A	A	A
Cellulube 90, 150, 220 300, 550, 1000	X	X	X	~	A	A	A	A
Chevron Clarity AW 32, 46, 68	A	A	A	A	X	A	A	A
Chevron FLO-COOL 180	F	F	F	~	X	A	A	A
Chevron FR-8, 10, 13, 20	X	X	X	X	A,7	A	A	A
Chevron Hydraulic Oils AW MV 15, 32, 46, 68, 100	A	A	A	A	X	A	A	A
Chevron HyJet IV (9)	X	X	X	X	A,7	A	A	A
Chevron Rykon MV	F	A	A	~	~	A	A	A
Cindol 3204 PBR	~	A	A	A	X	A	A	A
Citric Acid	F	A	A	X	A	X	X	6
Commonwealth EDM 242, 244	A	A	A	~	X	A	A	A
CompAir CN300	X	X	X	F	X	A	A	A
CompAir CS100, 200, 300, 400	X	X	X	F	X	A	A	A
Coolanol 15, 20, 25, 35, 45	A	A	A	A	A	A	A	A
Copper Chloride	F	A	A	X	A	X	X	X
Copper Sulfate	A	A	A	X	A	X	X	F
Cosmolubric HF-122, HF-130, HF-144	X	F	A	X	X	A	A	A
Cosmolubric HF-1530	X	F	A	X	X	A	A	A
Cottonseed Oil	F	A	A	F	X	A	A	A
CPI CP-4000	X	X	X	F	X	A	A	A
Crude Petroleum Oil	F	A	A	A	X	F	F	A
CSS 1001 Dairy Hydraulic Fluid	F	A	A	A	X	A	A	A
Daphne AW32	A	A	A	A	X	A	A	A
Dasco FR 201-A	A	A	A	~	X	A	A	A
Dasco FR150, 200, 310	F	A	A	~	A	A	A	A
Dasco FR300, FR2550	X	X	X	~	X	A	A	A

A

B

C

D

E

Media

Chemical Resistance Information (Page 3 of 9)

Warning: This chemical compatibility guide must not be used in conjunction with any other compatibility guides from previous or future catalog editions, bulletins or publications. Incorrect use of these charts could result in death, personal injury or property damage.

A

B

C

D

E

MEDIA	I	II	III	IV	V	Steel	Brass	SS
Dasco FR355-3	X	F	A	X	X	A	A	A
Deicer Fluid 419R	A	A	A	~	~	A	A	A
Deionized Water	A	A	A	A	A	F	F	A
Dexron II ATF	F	A	A	A	X	A	A	A
Dexron III ATF (to 170°F)	A	A	A	A	X	A	A	A
Dexron III ATF (to 212°F)	X	F	F	A	X	A	A	A
Dexron III ATF (to 250°F)	X	X	X	F	X	A	A	A
Dexron III ATF (to 300°F)	X	X	X	X	X			
Dexron VI ATF (to 170°F)	A	A	A	A	X	A	A	A
Dexron VI ATF (to 212°F)	X	F	F	A	X	A	A	A
Dexron VI ATF (to 250°F)	X	X	X	X	X	A	A	A
Dexron VI ATF (to 300°F)	X	X	X	X	X			
DexronIIIE/Mercon (at 212°F)	X	A	A	A	X	A	A	A
Diesel Fuel (Standard and Ultra Low Sulfur)	F,3	A,3	A,3	A,3	X	A	A	A
Diester Fluids	X	X	X	F	X	A	A	A
Dow Corning 2-1802 Sullair (24KT)	~	~	~	F	~	A	A	A
Dow Corning DC 200, 510, 550, 560, FC126	A	A	A	F	~	A	A	A
Dow HD50-4	F	F	F	~	~	~	~	A
Dow Sullube 32	~	~	~	F	~	A	A	A
Dowtherm A,E	X	X	X	F	X	A	A	A
Dowtherm G	X	X	X	X	X	A	A	A
Duro AW-16, 31	A	A	A	~	X	A	A	A
Duro FR-HD	A	A	A	~	X	A	A	A
EcoSafe FR-68	A	A	A	~	~	A	A	A
Envirologic 3032, 3046, 3068	A	A	A	~	~	~	~	~
Ethanol	F	F	F	F	F	F	A	A
Ethers	X	X	X	F	X	A	A	A
Ethyl Acetate	X	X	X	F	F	F	A	A
Ethyl Alcohol	F	F	F	F	F	F	A	A
Ethyl Cellulose	F	F	F	F	F	X	F	F
Ethyl Chloride	X	X	X	X	A	F	F	F
Ethylene Dichloride	X	X	X	F	X	X	A	X
Ethylene Glycol	F	A	A	A	A	A	F	A
Exxon 2380 Turbo Oil	X	F	F	X	X	A	A	A
Exxon 3110 FR	A	A	A	A	X	A	A	A
Exxon Esstic	A	A	A	A	A	A	A	A
Exxon Mobil Rarus SHC 1026	~	~	~	A	~	A	A	A
Exxon Nuto H 46, 68	A	A	A	A	X	A	A	A
Exxon Tellura Industrial Process Oils	A	A	A	A	X	A	A	A
Exxon Terresstic, EP	A	A	A	A	A	A	A	A
Exxon Turbo Oil 2380	X	F	F	F	X	A	A	A
Exxon Univolt 60, N61	F	A	A	A	X	A	A	A
FE 232 (Halon)	X	X	X	X	F	A	A	A

Media

Chemical Resistance Information (Page 4 of 9)

Warning: This chemical compatibility guide must not be used in conjunction with any other compatibility guides from previous or future catalog editions, bulletins or publications. Incorrect use of these charts could result in death, personal injury or property damage.

MEDIA	I	II	III	IV	V	Steel	Brass	SS
Fenso 150	~	A	A	~	X	A	A	A
Formaldehyde	X	X	X	A	A	X	F	A
Formic Acid	X	X	X	X	A	X	6	X
Freons see refrigerants	~	~	~	~	~	~	~	~
Fuel Oil	F	A	A	A	X	A	A	A
Fyre-Safe 120C, 126, 155, 1090E, 1150, 1220, 1300E	X	X	X	X	A,7	A	A	A
Fyre-Safe 200C, 225, 211	F	A	A	A	A	A	A	A
Fyre-Safe W/O	A	A	A	A	X	A	A	A
Fyrguard 150, 150-M, 200	A	A	A	A	A	A	A	A
Fyrquel 60, 90, 150, 220, 300, 550, 1000	X	X	X	X	A,7	A	A	A
Fyrquel EHC, GT, LT, VPF	X	X	X	X	A,7	A	A	A
Fyrtek MF, 215, 290, 295	X	X	X	X	X	A	A	A
Gardner-Denver GD5000, GD8000	X	X	X	F	X	A	A	A
Gasoline			See numeral 9			A	A	A
Glue	F	F	F	~	X	A	F	A
Glycerine, Glycerol	A	A	A	A	A	A	F	A
Grease	A	A	A	A	X	A	A	A
Green Plus ES	X	A	A	X	~	A	A	A
Greens Care 32, 46	F	A	A	F	~	A	A	A
Gulf-FR Fluid P37, P40, P43, P45, P47	X	X	X	F	A	A	A	A
H-515 (NATO)	A	A	A	~	X	A	A	A
Halon 1211, 1301	F	F	F	F	~	A	A	A
Helium Gas	X	X	X	X	X	A	A	A
Heptane	X	F	F	A	X	A	A	A
Hexane	X	F	F	A	X	A	A	A
HF-20, HF-28	~	A	A	A	A	A	A	A
Houghto-Safe 1055, 1110, 1115, 1120, 1130 (9)	X	X	X	X	A,7	A	A	A
Houghto-Safe 271 to 640	F	A	A	F	A	A	A	A
Houghto-Safe 419 Hydraulic Fluid	A	A	A	~	X	A	A	A
Houghto-Safe 419R Deicer Fluid	A	A	A	~	~	A	A	A
Houghto-Safe 5046, 5046W, 5047-F	A	A	A	A	X	A	A	A
HP 100C (Jack hammer oil)	F	A	A	A	X	A	A	A
HPWG 46B	F	A	A	F	~	A	A	A
Hul-E-Mul	A	A	A	~	X	A	A	A
Hychem C, EP1000, RDF	A	A	A	A	A	A	A	A
Hydra Safe E-190	A	A	A	F	X	A	A	A
Hydra-Cut 481, 496	A	A	A	~	X	A	A	A
Hydrafluid 760	A	A	A	~	X	A	A	A
Hydrochloric Acid	X	X	X	X	X	X	X	X
Hydrofluoric Acid	X	X	X	X	X	X	6	X
Hydrogen Gas	X	X	X	X	X	A	A	A
Hydrogen Peroxide	X	X	X	F	X	X	X	6
Hydrogen Sulfide	X	X	X	X	A	X	X	6
Hydrolube	A	A	A	F	A	A	A	A

A

B

C

D

E



Chemical Resistance Information

(Page 5 of 9)

Warning: This chemical compatibility guide must not be used in conjunction with any other compatibility guides from previous or future catalog editions, bulletins or publications. Incorrect use of these charts could result in death, personal injury or property damage.

MEDIA	I	II	III	IV	V	Steel	Brass	SS
Hydrolubric 120-B, 141, 595	F	A	A	F	A	A	A	A
Hydosafe Glycol 200	A	A	A	A	A	A	F	A
HyJet IV	X	X	X	X	A,7	A	A	A
Hyspin SP 10	~	A	A	A	~	A	A	A
Ideal Yellow 77	A	A	A	A	X	A	A	A
Imol S150 to S550	X	X	X	~	~	A	A	A
Ingersoll Rand SSR Coolant	X	X	X	F	X	A	A	A
Isocyanates	F	F	F	F	X	A	~	A
Isooctane	X	F	F	A	X	A	A	A
Isopar H	X	X	X	X	X	A	A	A
Isopropyl Alcohol	F	F	F	F	F	F	A	A
Jayflex DIDP	X	X	X	X	A	A	A	A
JP3 and JP4	X	A,3	A,3	~	X	A	A	A
JP5	X	A,3	A,3	F,3	X	A	A	A
JP9	X	X	X	X	X	A	~	A
Kaeser 150P, 175P, 325R, 687R	X	X	X	F	X	A	A	A
Kerosene	X	A	A	F	X	A	A	A
KSL-214, 219, 220, 222	X	X	X	F	X	A	A	A
Lacquer	X	X	X	F	X	X	A	A
Lacquer Solvents	X	X	X	F	X	X	A	A
Lactic Acids	X	X	X	X	X	X	X	A
Lindol HF	X	X	X	F	A	A	A	A
Linseed Oil	A	A	A	A	A	A	A	A
LP-Gas			See numeral 11			A	A	A
Magnesium Chloride	A	A	A	A	A	X	X	X
Magnesium Hydroxide	F	F	F	A	A	F	F	F
Magnesium Sulfate	A	A	A	A	A	A	F	A
Mercaptans	X	X	X	X	X	~	~	~
Methane			See numeral 12			A	A	A
Methanol	F	F	F	F	F	F	A	A
Methyl Alcohol	F	F	F	F	F	F	A	A
Methyl Chloride	X	X	X	F	X	A	A	A
Methyl Ethyl Ketone (MEK)	X	X	X	F	X	F	A	A
Methyl Isopropyl-Ketone	X	X	X	X	X	F	A	A
Metsafe FR303-M, FR303	X	X	X	X	X	A	A	A
Metsafe FR310, FR315, FR330, FR350	X	X	X	X	F, 7	A	A	A
Microzol-T46	X	A	A	~	X	A	A	A
MIL-B-46176A	X	X	X	X	X	X	X	X
MIL-H-46170	X	F	F	F	X	A	A	A
MIL-H-5606	F	A	A	A	X	A	A	A
MIL-H-6083	F	A	A	A	X	A	A	A
MIL-H-7083	F	A	A	A	X	A	A	A
MIL-H-83282	F	A	A	A	X	A	A	A
MIL-L-2104, 2104B	F	A	A	A	X	A	A	A

A

B

C

D

E



Chemical Resistance Information

(Page 6 of 9)

Warning: This chemical compatibility guide must not be used in conjunction with any other compatibility guides from previous or future catalog editions, bulletins or publications. Incorrect use of these charts could result in death, personal injury or property damage.

MEDIA	I	II	III	IV	V	Steel	Brass	SS
MIL-L-23699	X	X	X	X	X	A	A	A
MIL-L-7808	F	A	A	~	X	A	A	A
Mine Guard FR	A	A	A	~	A	A	A	A
Mineral Oil	A	A	A	F	X	A	A	A
Mineral Spirits	8	8	8	8	X	A	A	A
Mobil Aero HFE	F	A	A	F	X	A	A	A
Mobil DTE 11M, 13M, 15M, 16M, 18M, 19M	F	A	A	A	X	A	A	A
Mobil DTE 22, 24, 25, 26	F	A	A	A	X	A	A	A
Mobil EAL 224H	X	A	A	X	~	A	A	A
Mobil EAL Artic 10, 15, 22,32, 46, 68, 100	X	X	X	X	X	A	A	A
Mobil EAL Evirosyn 46	A	A	A	A	X	A	A	A
Mobil Glygoyle 11, 22, 30, 80	A	A	A	~	X	A	A	A
Mobil HFA	F	A	A	A	X	A	A	A
Mobil Jet 2	X	F	F	A	X	A	A	A
Mobil Nyvac 20, 30, 200, FR	F	A	A	F	A	A	A	A
Mobil Rarus 824, 826, 827	X	X	X	F	X	A	A	A
Mobil SHC 500 Series	A	A	A	A	X	A	A	A
Mobil SHC 600 Series	F	A	A	A	X	A	A	A
Mobil SHC 800 Series	F	A	A	A	X	A	A	A
Mobil SHL 624	~	A	A	A	X	A	A	A
Mobil Vactra Oil	A	A	A	F	X	A	A	A
Mobil XRL 1618B	X	X	X	X	A,7	A	A	A
Mobilfluid 423	F	A	A	A	X	A	A	A
Mobilgear SHC 150, 220, 320, 460, 680	F	F	F	F	X	A	A	A
Mobilrama 525	A	A	A	F	X	A	A	A
Molub-Alloy 890	X	X	X	F	X	A	A	A
Moly Lube 'HF' 902	F	F	F	F	X	A	A	A
Monolec 6120 Hydraulic Oil	A	A	A	A	X	A	A	A
Morpholine (pure additive)	X	X	X	X	X	X	X	A
Naptha	X	F	F	A	X	A	A	A
Napthalene	X	X	X	F	X	A	A	A
Natural Gas			See numeral 12			A	A	A
Nitric Acid	X	X	X	X	X	X	X	F
Nitrobenzene	X	X	X	F	X	X	X	A
Nitrogen, gas	F,1	F,1	F,1	F,1	F,1	A	A	A
Nitrogen, liquid	X	X	X	X	X	X	X	X
NORPAR 12, 13, 15	8	8	8	8	X	A	A	A
Nuto H 46, 68	A	A	A	A	X	A	A	A
Nyvac 20, 30, 200, FR	F	A	A	F	A	A	A	A
Nyvac Light	X	X	X	~	A	A	A	A
Oceanic HW	F	A	A	F	X	A	A	A
Oxygen	X	X	X	X	X	X	A	A
Ozone	F	F	F	~	A	A	A	A
Pacer SLC 150, 300, 500, 700	X	X	X	F	X	A	A	A

A

B

C

D

E

MEDIA

Chemical Resistance Information (Page 7 of 9)

Warning: This chemical compatibility guide must not be used in conjunction with any other compatibility guides from previous or future catalog editions, bulletins or publications. Incorrect use of these charts could result in death, personal injury or property damage.

MEDIA	I	II	III	IV	V	Steel	Brass	SS
Pennzbell AWX	F	A	A	F	X	A	A	A
Perchloroethylene	X	X	X	X	X	F	X	A
Petroleum Ether	X	F	F	F	X	A	A	A
Petroleum Oils	A	A	A	A	X	A	A	A
Phenol (Carbolic Acid)	X	X	X	A	X	X	F	A
Phosphate Ester Blends	X	X	X	X	X	A	A	A
Phosphate Esters	X	X	X	X	A,7	A	A	A
Phosphoric Acid	X	X	X	X	X	X	X	F
Plurasafe P 1000, 1200	F	A	A	A	F	A	A	A
Polyalkylene Glycol	A	A	A	~	X	A	A	A
Polyol Ester	X	F	A	X	X	A	A	A
Potassium Chloride	A	A	A	A	A	X	F	F
Potassium Hydroxide	X	X	X	F	A	6	X	A
Potassium Sulfate	A	A	A	A	A	A	A	A
Propane			See numeral 11			A	A	A
Propylene Glycol	F	A	A	A	A	F	F	F
Pydraul 10-E, 29-E, 50-E, 65-E, 90-E, 115-E	X	X	X	X	A,7	A	A	A
Pydraul 230-C, 312-C, 68-S	X	X	X	X	A,7	A	A	A
Pydraul 60, 150, 625, F9	X	X	X	X	A,7	A	A	A
Pydraul 90, 135, 230, 312, 540, MC	X	X	X	X	X	A	A	A
Pydraul A-200	X	X	X	F	X	A	A	A
Pyro Gard 43, 230, 630	X	X	X	X	X	A	A	A
Pyro Gard C, D, R, 40S, 40W	F	A	A	F	X	A	A	A
Pyro Guard 53, 55, 51, 42	X	X	X	X	A,7	A	A	A
Quakerol 641, 720	X	F	A	X	F	A	A	A
Quintolubric 700	A	A	A	A	A	A	F	A
Quintolubric 807-SN	F	A	A	~	X	A	A	A
Quintolubric 822, 833	X	F,5	A,5	X	X	A	A	A
Quintolubric 822-68EHC (71°C, 160°F maximum)	X	F,5	A,5	~	~	A	A	A
Quintolubric 888	X	F,5	A,5	X	X	A	A	A
Quintolubric 957, 958	F	A	A	F	A	A	A	A
Quintolubric N822-300	~	~	A	~	~	A	A	A
Rando	A	A	A	A	X	A	A	A
Rayco 782	X	F	A	X	X	X	X	X
Refrigerant 124			See numeral 4			A	A	A
Refrigerant Freon 113, 114	X	X	X	X	X	A	A	A
Refrigerant Freon 12			See numeral 4			A	A	A
Refrigerant Freon 22			See numeral 4			A	A	A
Refrigerant Freon 502			See numeral 4			A	A	A
Refrigerant HFC134A			See numeral 4			A	A	A
Reolube Turbofluid 46	X	X	X	X	A,7	A	A	A
Rotella	A	A	A	A	X	A	A	A
Royal Bio Guard 3032, 3046, 3068, 3100	X	~	A	X	X	A	A	A
Royco 2200, 2210, 2222, 2232, 2246, 2268	X	X	X	X	X	A	A	A
Royco 4032, 4068, 4100, 4150	X	X	X	F	X	A	A	A



Chemical Resistance Information

(Page 8 of 9)

Warning: This chemical compatibility guide must not be used in conjunction with any other compatibility guides from previous or future catalog editions, bulletins or publications. Incorrect use of these charts could result in death, personal injury or property damage.

MEDIA	I	II	III	IV	V	Steel	Brass	SS
Royco 756, 783	A	A	A	A	X	A	A	A
Royco 770	X	F	F	F	X	A	A	A
RTV Silicone Adhesive Sealants	X	X	X	X	X	A	A	A
Safco-Safe T10, T20	~	~	~	~	A	F	F	A
Safety-Kleen ISO 32, 46, 68 hydraulic oil	F	A	A	~	X	A	A	A
Safety-Kleen Solvent	F,8	F,8	F,8	F,8	X	A	A	A
Santoflex 13	F	F	F	~	F	A	A	A
Santosafe 300	X	X	X	~	X	A	A	A
Santosafe W/G 15 to 30	~	~	~	A	A	A	A	A
Schaeffer Oil #112 HTC @ 158°F max	A	A	A	~	X	A	A	A
Schaeffer Oil #112 HTC @ 158°F to 212°F	F	F	F	~	X	A	A	A
Schaeffer Oil #275 Dilex Supreme @ 158°F max	A	A	A	~	X	A	A	A
Schaeffer Oil #275 Dilex Supreme @ 158°F to 212°F	F	F	F	~	X	A	A	A
Sea Water	F	F	F	F	A	X	F	A
Sewage	F	F	F	A	F	X	F	A
Shell 140 Solvent	8	8	8	8	X	A	A	A
Shell Clavus HFC 68	X	X	X	X	X	A	A	A
Shell Comptella Oil	F	F	F	A	X	A	A	A
Shell Comptella Oil S 46, 68	F	F	F	A	X	A	A	A
Shell Comptella Oil SM	F	F	F	A	X	A	A	A
Shell Diala A, (R) Oil AX	F	A	A	F	X	A	A	A
Shell FRM	~	~	~	~	X	A	A	A
Shell IRUS 902, 905	A	A	A	~	A	A	A	A
Shell Pella-A	A	A	A	A	X	A	A	A
Shell Tellus	F	A	A	A	X	A	A	A
Shell Thermia Oil C	A	A	A	A	X	A	A	A
Shell Turbo R	X	F	F	A	X	A	A	A
SHF 220, 300, 450	X	X	A	X	X	A	A	A
Silicate Esters	A	F	F	A	X	A	A	A
Silicone Oils	A	A	A	~	~	A	A	A
Silicone Sealants	X	X	X	X	X	A	A	A
Skydrol 500B-4, LD-4	X	X	X	X	A,7	A	A	A
Soap Solutions	X	F	F	F	A	A	A	A
Soda Ash, Sodium Carbonate	A	A	A	A	A	A	F	A
Sodium Bisulfate	F	F	F	A	A	F	A	F
Sodium Chloride	F	F	F	A	A	X	F	A
Sodium Hydroxide	X	X	X	A	A	A	X	A
Sodium Hypochlorite	F	F	F	X	F	X	X	X
Sodium Nitrate	F	F	F	A	A	A	F	A
Sodium Peroxide	X	X	X	X	A	X	X	A
Sodium Silicate	A	A	A	A	A	A	A	A
Sodium Sulfate	A	A	A	A	A	A	A	A
Soybean Oil	F	A	A	A	A	A	A	A
SSR Coolant	X	X	X	F	X	A	A	A
Steam	X	X	X	X	X	F	A	A

A

B

C

D

E



Chemical Resistance Information

(Page 9 of 9)

Warning: This chemical compatibility guide must not be used in conjunction with any other compatibility guides from previous or future catalog editions, bulletins or publications. Incorrect use of these charts could result in death, personal injury or property damage.

MEDIA	I	II	III	IV	V	Steel	Brass	SS
Stoddard Solvent	8	8	8	8	X	A	A	A
Sulfur Chloride	X	X	X	F	X	X	X	X
Sulfur Dioxide	X	X	X	X	F	X	F	F
Sulfur Trioxide	X	X	X	F	F	X	X	X
Sulfuric Acid 0%-30% Room Temp	F,6	F,6	F,6	X	F,6	6	X	6
Summa-20, Rotor, Recip	X	X	X	F	X	A	A	A
Summit DSL-32,68,100,125	X	X	X	F	X	A	A	A
Sun Minesafe, Sun Safe	X	F	F	F	X	A	A	A
Sundex 8125	X	F	F	~	A	A	A	A
Suniso 3GS	A	A	A	A	X	A	A	A
Sun-Vis 722	X	F	F	~	X	A	A	A
Super Hydraulic Oil 100, 150, 220	A	A	A	A	X	A	A	A
SUVA MP 39, 52, 66	X	X	X	X	X	A	A	A
SYNCON Oil	X	X	X	X	X	A	A	A
Syndale 2820	X	F	F	~	~	A	A	A
Synesstic 32,68,100	X	X	X	X	X	A	A	A
Syn-Flo 70,90	X	X	X	F	X	A	A	A
SYN-O-AD 8478	X	X	X	X	A,7	A	A	A
Tannic Acid	F	A	A	F	A	X	F	X
Tar	F	F	F	F	X	X	F	A
Tellus (Shell)	F	A	A	A	X	A	A	A
Texaco 760 Hydrafluid	~	~	~	~	X	A	A	A
Texaco 766, 763 (200 - 300)	~	~	~	~	A	F	F	A
Texaco A-Z Oil	A	A	A	F	X	A	A	A
Texaco Spindura Oil 22	F	F	F	F	X	A	A	A
Texaco Way Lubricant 68	A	A	A	A	X	A	A	A
Thanol-R-650-X	X	F	F	~	X	A	A	A
Thermanol 60	X	X	X	X	X	A	A	A
Toluene, Toluol	X	X	X	X	X	A	A	A
Transmission Oil	A	A	A	A	X	A	A	A
Tribol 1440	X	F	F	X	X	A	A	A
Trichloroethylene	X	X	X	F	X	X	A	A
Trim-Sol	F	A	A	F	X	A	A	A
Turbinol 50, 1122, 1223	X	X	X	X	A,7	A	A	A
Turpentine	X	X	X	F	X	A	A	A
Ucon Hydrolubes	F	A	A	F	A	A	A	A
UltraChem 215,230,501,751	X	X	X	F	X	A	A	A
Univis J26	A	A	A	A	X	A	A	A
Unleaded Gasoline			See numeral 9		~	A	A	A
Unocal 66/3 Mineral Spirits	8	8	8	8	X	A	A	A
Urea	F	F	F	A	F	F	~	F
Urethane Formulations	A	A	A	A	~	A	A	A
Van Straaten 902	A	A	A	A	X	A	A	A
Varnish	X	X	X	F	X	F	F	A
Varsol	8	F	F	8	X	A	A	A
Versilube F44, F55	~	A	A	A	~	A	A	A
Vinegar	X	X	X	F	A	F	X	A
Vital 29, 4300, 5230, 5310	X	X	X	X	X	A	A	A
Volt Esso 35	A	A	A	A	X	A	A	A
Water	F	A	A	A	A	F	A	A
Water / Glycols	A	A	A	A	A	A	F	A
Xylene, Xylol	X	X	X	X	X	A	A	A
Zerol 150	A	A	A	A	X	A	A	A
Zinc Chloride	A	A	A	X	A	X	X	F
Zinc Sulfate	A	A	A	X	A	X	A	A

A

B

C

D

E

Pressure

Pressure Rating of Hose End Connections

PRESSURE RATINGS HOSE ASSEMBLIES - PSI

THE MAXIMUM DYNAMIC WORKING PRESSURE OF THE HOSE ASSEMBLY IS THE LESSER OF THE RATED WORKING PRESSURE OF THE HOSE AND THE END CONNECTIONS USED.

Hose End Connection Description	Part Number Codes	Inch Size Fittings (psi)												
		-2	-4	-5	-6	-8	-10	-12	-16	-20	-24	-32	-40	-48
Male Pipe (NPTF)	01	12,000	12,000		10,000	10,000		7,500	6,500	5,000	3,000	2,500		
Female Pipe (NPTF, NPSM)	02 & 07	7,500	7,000		6,000	5,000		4,000	3,000	2,500	2,000	2,000		
Male Pipe (BSP)	91 & D9	5,000	9,000		8,000	6,250		5,000	4,000	3,500	3,000	3,000		
Female Pipe (BSP)	92, B1, B2 & B4	5,000	9,000		8,000	6,250	5,500	5,000	4,000	3,500	3,000	3,000		
JIS	FU, GU, MU & UT		5,000		5,000	5,000		4,000	3,000	2,500	1,500	1,500		
O-Ring Swivel and 45° Flare*	13, 1L, S2, 0G, 0L, 48, 08, 77 & 79		3,000	3,000	3,000	3,000	2,750	2,250	2,000	1,625	1,250	1,125		
37° Flare and Straight Thread*	03, 05, 06**, 37, 39**, 41, L7 & L9		6,000	6,000	5,000	5,000	5,000	5,000	4,000	3,000	2,500	2,500		
SAE Flareless	11 & 12		6,000	6,000	5,600	5,600	4,200	4,200	3,500	3,500	3,000	3,000		
SAE Inverted Flare	28, 67 & 69		2,750	2,500	2,250	2,000								
Seal-Lok® (O-ring Face Seal)	JM, JC, JS, J0, J1, J5, J7 & J9		9,200		9,200	9,200	6,000	6,000	6,000	4,000	4,000			
SAE Flanges Code 61	15, 16, 17, 18, 19, 26, 27 & 89						5,000	5,000	5,000	4,000	4,000	3,000	2,500	2,000
SAE Flanges Code 61 Special	4A, 4F & 4N									5,000	5,000	5,000		
SAE Flanges Code 62	6A, 6E, 6F, 6G, 6N, XA, XF, XG & XN							6,000	6,000	6,000	6,000	6,000		

For adapter pressure ratings, see Tube Fittings Division catalog 4300.

*NOTE: 45°, 37° and Seal-Lok Torque Tables are on page E-17

**NOTE: For pressure rating of 01, 06 and 39 end configurations in 73, 77, 78, and 79 series, see each description in Section B.

Hose End Connection Description	Part Number Codes	Metric Fittings (psi)															
		-6	-8	-10	-12	-14	-15	-16	-18	-20	-22	-25	-28	-30	-35	-38	-42
DIN Light "L" without O-Ring	C3, C4, C5 & 1D	3,500	3,500	3,500	3,500		3,500		2,250		2,250		1,400		1,400		1,400
DIN Light "L" with O-Ring	D0, CA, CE & CF	4,500	4,500	4,500	4,500		4,500		2,250		2,250		2,250		2,250		2,250
DIN Heavy "S" without O-Ring	C6, C7, C8 & 3D		9,000	9,000	9,000	9,000		5,750		5,750		5,750		3,500		3,500	
DIN Heavy "S" with O-Ring	C9, 0C, 1C & D2		9,000	9,000	9,000	9,000		6,000		6,000		6,000		6,000		4,500	
DIN 20078 Form C	C0									900		900		900		900	
Banjo	49	3,000	3,000	3,000	3,000		3,000		3,000	3,000	3,000						
French Metric	F9 & FA			3,000	3,500	2,000		2,250	2,000	1,900				1,750			

Hose End Connection Description	Part Number Codes	French Gaz Fittings (psi)				
		-13	-17	-21	-27	-33
French Gaz	F4, FG, GJ & GE	5,250	3,900	3,700	3,000	2,500

*NOTE: ALL THE ABOVE RATINGS ARE BASED ON LOW CARBON STEEL HOSE FITTINGS. HIGHER PRESSURE RATINGS CAN BE ATTAINED WITH MEDIUM CARBON AND ALLOY STEEL HOSE FITTINGS AND MATING ADAPTERS.

PRESSURE RATING OF HOSE - PSI

THE MAXIMUM WORKING PRESSURES OF HOSES ARE LISTED WITH EACH HOSE DESCRIPTION IN SECTION A.

A
B
C
D
E

Pressure

Metric Pressure Conversions

A

B

C

D

E

PRESSURE CONVERSIONS									
Kilo-Pascals (kPa)	Mega-Pascals (MPa)	Bar (bar)	Kilograms per Square Centimeter (Kgf/cm ²)	lbs per Square Inch (psi)	lbs per Square Inch (psi)	Kilo-Pascals (kPa)	Mega-Pascals (MPa)	Bar (bar)	Kilograms per Square Centimeter (Kgf/cm ²)
100	0,1	1,00	1.0	14.50	10	68.9	0,07	0,7	0.70
200	0,2	2,00	2.0	29.00	20	137.9	0,14	1,4	1.41
300	0,3	3,00	3.1	43.50	30	206.8	0,21	2,1	2.11
400	0,4	4,00	4.1	58.00	40	275.8	0,28	2,8	2.81
500	0,5	5,00	5.1	72.50	50	344.7	0,34	3,4	3.52
600	0,6	6,00	6.1	87.00	60	413.7	0,41	4,1	4.22
700	0,7	7,00	7.1	101.50	70	482.6	0,48	4,8	4.92
800	0,8	8,00	8.2	116.00	80	551.6	0,55	5,5	5.63
900	0,9	9,00	9.2	130.50	90	620.5	0,62	6,2	6.33
1000	1,0	10,00	10.2	145.00	100	689.0	0,70	6,9	7.00
2000	2,0	20,00	20.4	290.10	200	1379.0	1,40	13,8	14.10
3000	3,0	30,00	30.6	435.10	300	2068.0	2,10	20,7	21.10
4000	4,0	40,00	40.8	580.20	400	2758.0	2,80	27,6	28.10
5000	5,0	50,00	51.0	725.20	500	3447.0	3,40	34,5	35.20
6000	6,0	60,00	61.2	870.20	600	4137.0	4,10	41,4	42.20
7000	7,0	70,00	71.4	1015.30	700	4826.0	4,80	48,3	49.20
8000	8,0	80,00	81.6	1160.30	800	5516.0	5,50	55,2	56.30
9000	9,0	90,00	91.8	1305.30	900	6205.0	6,20	62,1	63.30
10000	10,0	100,00	102.0	1450.00	1000	6895.0	6,90	68,9	70.30
20000	20,0	200,00	204.0	2901.00	2000	13790.0	13,80	137,9	140.70
30000	30,0	300,00	306.0	4351.00	3000	20684.0	20,70	206,8	211.00
40000	40,0	400,00	408.0	5802.00	4000	27579.0	27,60	275,8	281.30
50000	50,0	500,00	510.0	7252.00	5000	34474.0	34,50	344,7	351.60
60000	60,0	600,00	612.0	8702.00	6000	41369.0	41,40	413,7	421.90
70000	70,0	700,00	714.0	10153.00	7000	48263.0	48,30	482,6	492.30
80000	80,0	800,00	816.0	11603.00	8000	55158.0	55,20	551,6	562.60
90000	90,0	900,00	918.0	13053.00	9000	62053.0	62,10	620,5	632.90
100000	100,0	1000,00	1020.0	14504.00	10000	68948.0	68,90	689,0	703.00
200000	200,0	2000,00	2040.0	29008.00	20000	137895.0	137,90	1379,0	1406.00
300000	300,0	3000,00	3060.0	43511.00	30000	206843.0	206,80	2068,0	2110.00
					40000	275790.0	275,80	2758,0	2813.00

C Conversions

PSI and MPa or N/mm2 Conversions

Pounds per Square Inch (abbrev. PSI) - A basic unit of pressure or tension measurement in the Imperial or English System of Weights and Measures.

$$1 \text{ psi} = .006895 \text{ MPa},$$

$$1000 \text{ psi} = 1 \text{ ksi}$$

MegaPascal (abbrev. MPa) - A basic unit of pressure or tension measurement in the International System of Weights and Measures.

$$1 \text{ MPa} = 145 \text{ psi},$$

$$1 \text{ MPa} = 1 \text{ N/mm}^2.$$

For oil field applications, units of measurement smaller than 1 psi usually have little meaning. Units of MPa may often appear with a decimal.

$$\text{Example: } 1000 \text{ psi} = 6.895 \text{ MPa}.$$

1 MegaPascal (MPa) = 1 Newton per Square Millimeter (N/mm²) = 145 Pounds per Square Inch (psi).

Psi, Ksi, MPa, and N/mm² all express force measurement, either pressure (as fluid pressure) or load (as tension). All of these terms may appear as pressure ratings or test pressures, and tensile or yield requirements or test results.

API Spec 6A specifies equipment pressure ratings in both PSI, and MPa as:

2,000 psi	=	13.8 MPa	=	138 bar
3,000 psi	=	20.7 MPa	=	207 bar
5,000 psi	=	34.5 MPa	=	345 bar
10,000 psi	=	69.0 MPa	=	690 bar
15,000 psi	=	103.5 MPa	=	1,035 bar
20,000 psi	=	138.0 MPa	=	1,380 bar

Bar pressure provided for information only.

To express PSI pressures in bars, convert PSI to MPa and move the decimal in the MPa value 1 space to the right, e.g. 5000 PSI = 34.5 MPa = 345 bar.

API Spec 6A specifies material property requirements* as:

Material Designation	Yield		Tensile	
	PSI	MPa	PSI	MPa
36 K	36,000	248	70,000	483
45 K	45,000	310	70,000	483
60 K	60,000	414	85,000	586
75 K	75,000	517	95,000	655

*For Elongation and Reduction of Area, see API Spec 6A. The values specified for these requirements do not require conversion.

A

B

C

D

E

PART NUMBER	PAGE NUMBER	PART NUMBER	PAGE NUMBER	PART NUMBER	PAGE NUMBER
0188	B-198	3788	B-199	11770	B-63
015301	C-14	3988	B-199	11771	B-76
017M	B-6	8888	B-202	11773	B-87
01TB	B-206	10081	B-202	11777	B-100
025411	C-14	10125	B-6	11778	B-111
05TB	B-207	10126	B-11	11843	B-41
201	A-48	10143	B-29	11871	B-77
206	A-48	10170	B-62	11943	B-41
213	A-47	10171	B-72	11970	B-63
239	C-23	10173	B-86	11971	B-77
244	A-55	10177	B-97	11973	B-87
266	A-47	10178	B-110	11977	B-100
271	A-50	10243	B-30	11978	B-111
285	A-54	10326	B-11	12643	B-40
293	A-46	10343	B-32	12671	B-76
302	A-29	10370	B-62	12743	B-41
304	A-43	10371	B-72	12771	B-76
339	C-23	10377	B-97	12826	B-14
422	A-26	10426	B-13	12843	B-38
424	A-42	10443	B-36	13726	B-12
426	A-28	10543	B-31	13743	B-34
431	A-30	10571	B-72	13771	B-73
436	A-31	10577	B-97	13777	B-98
0588	B-198	10626	B-12	13926	B-12
0688	B-199	10643	B-33	13943	B-35
701	A-35	10670	B-62	13970	B-62
711	A-12	10671	B-73	13971	B-74
721	A-16	10673	B-86	13973	B-86
731	A-35	10677	B-97	13977	B-98
761	A-25	10678	B-110	13978	B-110
774	A-43	10743	B-31	14126	B-13
781	A-20	10825	B-6	14143	B-36
801	A-38	10826	B-13	14171	B-74
804	A-40	10843	B-36	14943	B-58
811	A-36	11143	B-37	16726	B-15
821	A-41	11243	B-38	16743	B-39
836	A-40	11343	B-29	16826	B-14
881	A-37	11543	B-39	16926	B-15
1588	B-199	11571	B-75	16943	B-39
1788	B-200	11573	B-86	17726	B-13
1988	B-200	11577	B-99	17743	B-37
2188	B-198	11578	B-110	17926	B-14
2726	C-28	11643	B-40	17943	B-37
2727	C-28	11671	B-75	18971	B-78
3188	B-198	11743	B-40	19243	B-56

A

B

C

D

E

PART NUMBER	PAGE NUMBER	PART NUMBER	PAGE NUMBER	PART NUMBER	PAGE NUMBER
19270	B-67	24120	B-144	711510	D-16
19273	B-92	24121	B-153	871522	C-26
20120	B-142	24130	B-170	881540	C-26
20121	B-152	24142	B-176	101HY	B-127
20122	B-160	24248	C-23	101S6	B-118
20130	B-168	24398	C-23	102HY	B-128
20142	B-174	26120	B-147	103HY	B-130
20320	B-142	26720	B-146	105HY	B-129
20330	B-169	26721	B-154	106HY	B-131
20342	B-175	26920	B-147	106S6	B-118
20420	B-144	26921	B-155	107HY	B-128
20530	B-168	27720	B-145	108HY	B-133
20542	B-174	27721	B-153	10C43	B-55
20620	B-143	27920	B-145	10C70	B-67
20621	B-152	27921	B-154	10C73	B-91
20622	B-160	28120	B-146	10C77	B-107
20623	B-164	30182	B-182	10C78	B-117
20630	B-169	30282	B-183	10G43	B-31
20642	B-175	30382	B-183	10GHY	B-129
20820	B-145	30482	B-185	10L43	B-32
20821	B-153	30682	B-184	10LHY	B-130
20822	B-160	30882	B-185	111HY	B-134
20823	B-164	31382	B-182	113HY	B-127
20830	B-170	32882	B-186	11C43	B-56
20842	B-176	32982	B-186	11C70	B-67
21120	B-146	33482	B-188	11C73	B-92
21230	B-171	33782	B-184	11C77	B-106
21330	B-168	33982	B-184	11C78	B-117
21342	B-174	34182	B-184	11D43	B-51
21520	B-147	34982	B-190	11L43	B-30
21720	B-148	36782	B-186	11LHY	B-128
21920	B-148	36982	B-186	128HY	B-135
22820	B-146	37782	B-185	129HY	B-136
22821	B-154	37982	B-185	12U71	B-78
23220	B-147	38282	B-188	134HY	B-135
23221	B-154	39282	B-189	137HY	B-132
23223	B-164	580661	C-23	139HY	B-132
23720	B-143	601069	C-29	13D43	B-54
23721	B-152	631075	C-23	13DHY	B-139
23730	B-170	631076	C-23	141HY	B-133
23742	B-176	631140	C-23	14526-PR	B-18
23920	B-144	652200	C-28	14526-PT	B-18
23921	B-153	652201	C-28	14A73	B-87
23930	B-170	662451	C-27	14A77	B-100
23942	B-176	711509	D-16	14A78	B-111

A

B

C

D

E



A

B

C

D

E

PART NUMBER	PAGE NUMBER	PART NUMBER	PAGE NUMBER	PART NUMBER	PAGE NUMBER
14AS6	B-118	16F71	B-78	1C977	B-106
14F73	B-87	16F43	B-42	1C978	B-117
14F77	B-100	16F73	B-88	1CA43	B-53
14F78	B-111	16F77	B-101	1CA70	B-68
14FS6	B-118	16E78	B-112	1CA73	B-91
14N73	B-88	16F78	B-113	1CE43	B-53
14N77	B-101	16F79	B-122	1CE70	B-68
14N78	B-112	16FS6	B-119	1CF43	B-53
14NS6	B-118	16G78	B-113	1CF70	B-69
14V43	B-36	16G79	B-122	1D043	B-51
15926-PB	B-20	16N43	B-42	1D0HY	B-139
15926-PT	B-20	16N70	B-64	1D243	B-54
15G26	B-19	16N71	B-79	1D270	B-69
15G26-PR	B-19	16N73	B-88	1D271	B-82
15H26	B-20	16N77	B-102	1D273	B-91
15K26	B-17	16N78	B-113	1D277	B-107
15K26-PB	B-17	16N79	B-123	1D278	B-117
15K26-PR	B-18	16NS6	B-119	1D943	B-56
15L26	B-21	177HY	B-134	1D970	B-69
15L26-PB	B-21	179HY	B-134	1D973	B-92
15L26-PR	B-22	17B25	B-6	1D9HY	B-139
15L26-PT	B-22	17B26	B-22	1EN43	B-50
15M26-PR	B-18	17T3	D-5	1ET43	B-50
15M26-PT	B-19	18A76	B-95	1EU43	B-50
15N26-PB	B-21	18F76	B-95	1F443	B-60
15N26-PT	B-21	18N76	B-95	1FG70	B-66
15P26-PT	B-22	193HY	B-133	1FU43	B-59
15R26	B-17	19T3	D-5	1FU71	B-83
15S26	B-19	1B143	B-57	1G173	B-90
15T26	B-20	1B170	B-67	1G273	B-90
15T3	D-5	1B173	B-93	1GJ43	B-38
15V26	B-23	1B243	B-57	1GJHY	B-134
15W26	B-23	1B270	B-68	1GU43	B-60
15Z26	B-23	1B273	B-93	1GU70	B-66
167HY	B-135	1B443	B-57	1GU71	B-82
169HY	B-136	1B543	B-58	1GU73	B-90
16A43	B-42	1C043	B-55	1GU77	B-107
16A70	B-63	1C343	B-52	1GU78	B-117
16A71	B-78	1C443	B-52	1GUHY	B-140
16A73	B-88	1C543	B-52	1J043	B-43
16A77	B-101	1C643	B-54	1J071	B-79
16A78	B-112	1C943	B-55	1J077	B-105
16A79	B-122	1C970	B-68	1J0HY	B-136
16AS6	B-119	1C971	B-82	1J143	B-48
16B78	B-112	1C973	B-91	1J170	B-65

PART NUMBER	PAGE NUMBER	PART NUMBER	PAGE NUMBER	PART NUMBER	PAGE NUMBER
1J171	B-81	1MU43	B-59	2J920	B-149
1J177	B-105	1MU71	B-83	2J930	B-171
1J1HY	B-138	1RV26	B-23	2J942	B-177
1J543	B-47	1RZ26	B-24	2JS20	B-148
1J570	B-65	1S243	B-30	2JS30	B-171
1J571	B-81	1S526	B-16	2JS42	B-177
1J643	B-45	1S526-PR	B-17	2S521	B-155
1J726	B-16	1T126	B-24	301LT	A-44
1J743	B-46	1UT43	B-60	31D82	B-189
1J770	B-64	1UT71	B-82	31TB	B-206
1J771	B-80	1UTHY	B-140	332T-115V	C-23
1J773	B-89	1X577	B-98	351TC/ST	A-13
1J777	B-105	1X777	B-99	35TB	B-207
1J778	B-116	1X977	B-99	37G82	B-183
1J779	B-123	1XA77	B-102	39T3	D-6
1J7HY	B-137	1XA78	B-114	3B282	B-189
1J926	B-16	1XA79	B-124	3C382	B-192
1J943	B-47	1XAS6	B-119	3C482	B-191
1J970	B-65	1XB77	B-103	3C582	B-192
1J971	B-81	1XB78	B-114	3CA82	B-191
1J973	B-89	1XE78	B-114	3CF82	B-191
1J977	B-106	1XF77	B-102	3D082	B-188
1J978	B-116	1XF78	B-115	3D982	B-189
1J979	B-124	1XF79	B-124	3J182	B-187
1J9HY	B-138	1XG77	B-103	3J782	B-187
1JB43	B-43	1XG78	B-115	3J982	B-187
1JC26	B-15	1XN77	B-103	3JC82	B-187
1JC43	B-44	1XN78	B-115	40B-Cabinet	D-29
1JC70	B-64	1XN79	B-124	41T3	D-6
1JC71	B-79	1XU43	B-59	432-115V	C-27
1JC77	B-104	1XU71	B-83	451 Twin Tough	A-11
1JCHY	B-136	1XUHY	B-140	451ST	A-10
1JS43	B-45	1ZM77	B-107	451TC	A-10
1JS70	B-64	21130	B-171	46-83A	B-193
1JS71	B-80	21TB	B-206	471ST	A-32
1JS73	B-89	221FR	A-53	471TC	A-32
1JS77	B-104	25H21	B-156	471TC Twin Tough	A-33
1JS78	B-116	25L21	B-156	472LT	A-45
1JS79	B-123	25M21	B-155	472TC	A-33
1JSHY	B-137	25N21	B-156	482ST	A-27
1JSS6	B-119	25S21	B-155	482TC	A-27
1L743	B-34	25T21	B-156	4AH3	D-6
1L943	B-35	25TB	B-207	4AJM	D-8
1L971	B-74	2J120	B-149	4FH3	D-7
1LB43	B-33	2J720	B-148	4FJM	D-8

A

B

C

D

E



PART NUMBER	PAGE NUMBER	PART NUMBER	PAGE NUMBER	PART NUMBER	PAGE NUMBER
4NH3	D-7	82C-CVR	C-29	AG-066	D-22
4NJM	D-8	82C-R01	C-8	AG-072	D-22
4PG	D-22	82C-R01-PFD	C-14	AG-084	D-22
5050HK	D-11	82C-R02	C-8	AM	B-190
50H	D-10	83C-080	C-12	AM Banjo Bolt	B-58
5151HK	D-11	83C-0DR	C-27	AS-B	D-20
51H	D-11	83C-CVR	C-29	AS-Y	D-20
59RG	D-18	83C-KDA	C-12	AX	A-34
611HT	A-49	83C-OCB	C-12	BXX	A-34
6AH3	D-7	83C-R02	C-12	C9RG	D-16
6AJM	D-9	83C-R02H	C-12	CL	D-25
6FH3	D-7	83C-S20	C-12	CORG	D-18
6FJM	D-9	83C-S40	C-12	D9DT	D-16
6NH3	D-8	85C-00L	C-8	F42	A-43
6NJM	D-9	85C-00L	C-10	FSC Clamp	D-24
6PG	D-22	85C-0EP	C-16	FS-F	D-23
721ST	A-17	85C-0HP	C-16	FSS Firesleeve Sealant	D-24
721TC	A-16	85C-12V	C-16	FST-711617	D-24
722LT	A-45	85C-1PH	C-8	HC	D-26
722TC	A-14	85C-1PH	C-10	HFH	D-12
72B-Cabinet	D-29	85C-CHD	C-10	HFHFHK	D-12
772TC/ST	A-15	85C-R01	C-10	HG	D-21
782ST	A-21	85C-R02	C-10	Hose Assembly Workstations	D-28
782TC	A-21	85C-STD	C-8	Hose Oil	C-29
787TC	A-18	8888	B-202	HP	D-27
791TC	A-24	88DB	B-202	HP-B	D-27
792LT	A-45	88DB	D-26	HT	D-27
792ST	A-24	88HC	B-202	J0RG	D-17
792TC	A-24	88HC-H	B-202	J788	B-201
797TC	A-22	88HC-H	D-26	J988	B-201
7PG	D-22	8ARG	D-17	JC88	B-201
80C-0DR	C-27	8FH	D-12	JK	A-25
80C-Axx	C-22	8FHFHK	D-12	JS88	B-200
80C-SDR-BASE	C-27	8GC-002	C-22	M1H	D-14
80C-SDR-LG	C-27	8PC-001	C-22	M1M1HK	D-14
80C-SDR-SM	C-27	8PC-00P	C-22	M2H	D-15
80C-SDR-XXXX	C-27	8PC-030	C-22	M2M2HK	D-15
811HT	A-37	8PG	D-22	P35	A-20
81C-R01	C-22	8WC-001	C-22	PG	D-21
81C-R02	C-22	8WC-00P	C-22	PLM-1	B-194
821FR	A-41	94C-080-PFD	C-14	PS-B	D-20
82C-0AP	C-16	Accrolube	C-29	PS-BV	D-19
82C-0EP	C-16	AG	D-22	R12X	D-13
82C-0HP	C-16	AG-050	D-22	R16X	D-13
82C-CHD	C-8	AG-060	D-22		

A

B

C

D

E

PART NUMBER	PAGE NUMBER	PART NUMBER	PAGE NUMBER	PART NUMBER	PAGE NUMBER
R20X	D-13	TH6-10-P33	C-25		
R24X	D-13	TH6-10-P40	C-25		
R32X	D-13	TH6-10-P50	C-25		
RK-12	D-13	TH6-10-P60	C-25		
RK-16	D-13	TH7-4	D-28		
RK-20	D-13	TH7-5-C	D-29		
RK-24	D-13	TH7-5-HT	D-29		
RK-32	D-13	TH7-5-R	D-29		
SG	D-22	TH7-5-S	D-29		
SS23CG	A-51	TH7-6	D-29		
SS25UL	A-52	TH7-6-C	D-29		
T1RG	D-18	TH7-7	D-29		
TH11-1	C-26	TH7-8	D-29		
TH2-7	C-27	TH7-8-F	D-29		
TH2-7-ELS	C-27	TH9-1-26A	C-26		
TH2-7M25-6	C-28	TH9-1-26B	C-26		
TH2-7M25-8	C-28	TH9-1-43A	C-26		
TH3-50-1	C-23	TH9-1-43B	C-26		
TH3-50-2	C-23	TH9-1-70	C-26		
TH3-51	C-23	TH9-1-71	C-26		
TH6-10-4-FFORX	C-25	TH9-1-73	C-26		
TH6-10-EL-7	C-24	TH9-1-77	C-26		
TH6-10-H06	C-25	TH9-1-78	C-26		
TH6-10-H06	C-25	TH9-1-79	C-26		
TH6-10-H06	C-25	TH9-1-HY	C-26		
TH6-10-H10	C-25	TH9-1-XXX	C-26		
TH6-10-H10	C-25	XARG	D-17		
TH6-10-H13	C-25	XCXCHK	D-15		
TH6-10-H13	C-25	XRG-12	D-13		
TH6-10-H16	C-25	XRG-16	D-13		
TH6-10-H16	C-25	XRG-20	D-13		
TH6-10-H19	C-25	XRG-24	D-13		
TH6-10-H19	C-25	XRG-32	D-13		
TH6-10-H25	C-25				
TH6-10-H25	C-25				
TH6-10-H32	C-25				
TH6-10-H38	C-25				
TH6-10-H50	C-25				
TH6-10-HL-9-2	C-24				
TH6-10-P06	C-25				
TH6-10-P10	C-25				
TH6-10-P14	C-25				
TH6-10-P18	C-25				
TH6-10-P22	C-25				
TH6-10-P26	C-25				

A

B

C

D

E

Male Pipe Thread Sizes

A



SAE (JIC) 37° Flare Nose Cone Sizes

B

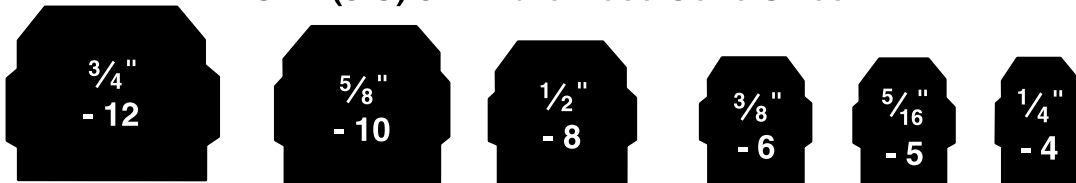

SAE (JIC) 37° Flare Nose Cone Sizes

C

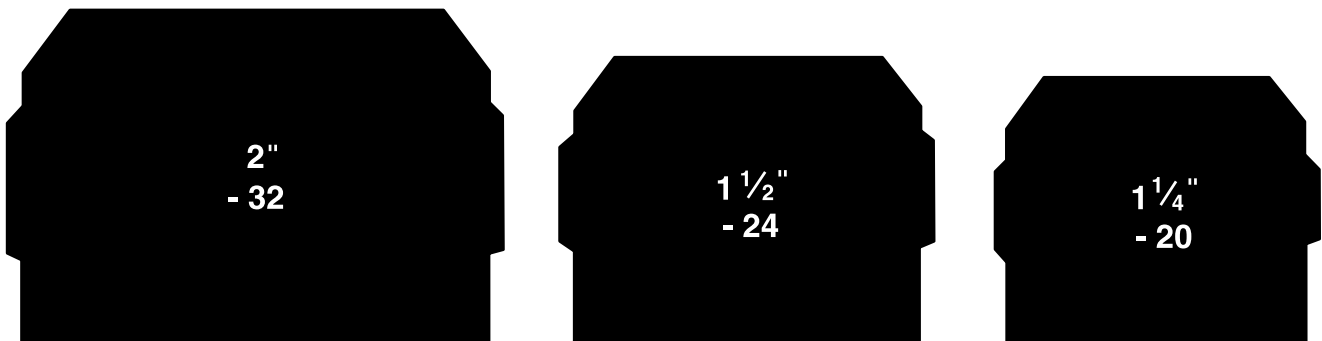

D

E

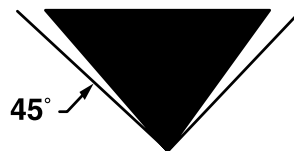
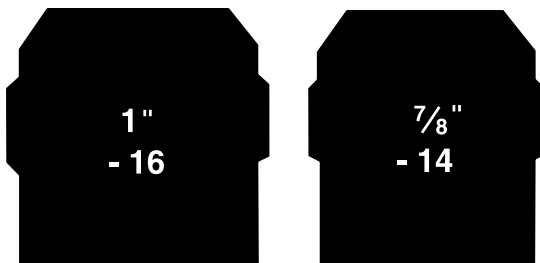

37° and 45° Flare Nose Angles

SAE 45° Flare Nose Cone Sizes

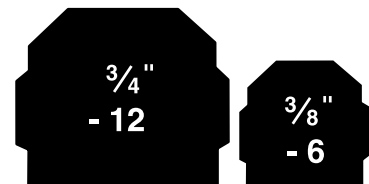

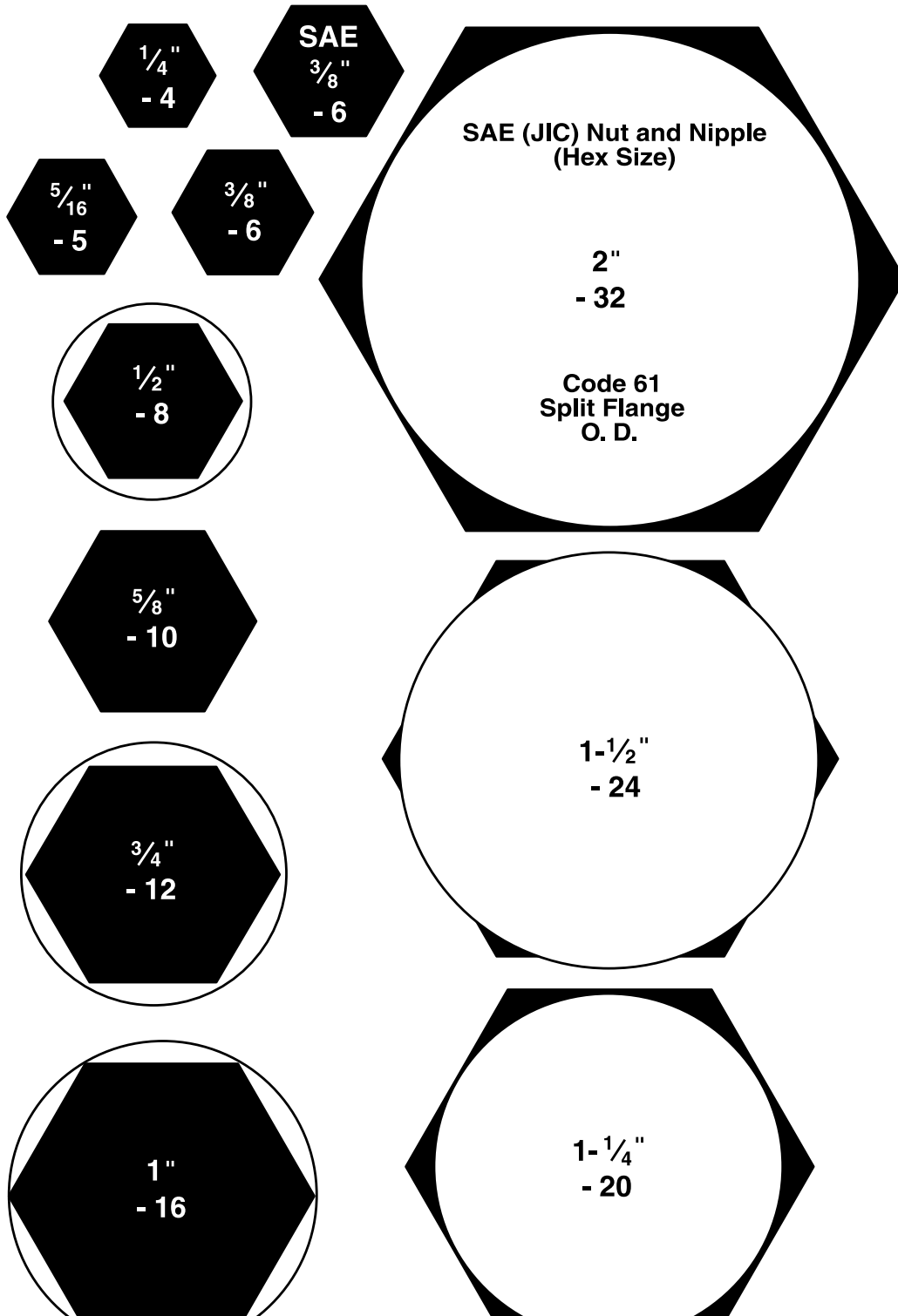

Safety Guide

Parker Safety Guide for Selecting and Using Hose, Tubing, Fittings and Related Accessories

Parker Publication No. 4400-B.1
Revised: November, 2007

WARNING: Failure or improper selection or improper use of hose, tubing, fittings, assemblies or related accessories ("Products") can cause death, personal injury and property damage. Possible consequences of failure or improper selection or improper use of these Products include but are not limited to:

- Fittings thrown off at high speed.
- High velocity fluid discharge.
- Explosion or burning of the conveyed fluid.
- Electrocutation from high voltage electric powerlines.

- Contact with suddenly moving or falling objects that are controlled by the conveyed fluid.
- Injections by high-pressure fluid discharge.
- Dangerously whipping Hose.
- Contact with conveyed fluids that may be hot, cold, toxic or otherwise injurious.
- Sparking or explosion caused by static electricity buildup or other sources of electricity.
- Sparking or explosion while spraying paint or flammable liquids.
- Injuries resulting from inhalation, ingestion or exposure to fluids.

Before selecting or using any of these Products, it is important that you read and follow the instructions below. Only Hose from Parker's Stratoflex Products Division is approved for in flight aerospace applications.

1.0 GENERAL INSTRUCTIONS

1.1 **Scope:** This safety guide provides instructions for selecting and using (including assembling, installing, and maintaining) these Products. For convenience, all rubber and/or thermoplastic products commonly called "hose" or "tubing" are called "Hose" in this safety guide. All assemblies made with Hose are called "Hose Assemblies". All products commonly called "fittings", "couplings" or "adapters" are called "Fittings". All related accessories (including crimping and swaging machines and tooling) are called "Related Accessories". This safety guide is a supplement to and is to be used with the specific Parker publications for the specific Hose, Fittings and Related Accessories that are being considered for use. Parker publications are available at www.parker.com. SAE J1273 (www.sae.org) and ISO 17165 2 (www.ansi.org) also provide recommended practices for hydraulic Hose Assemblies.

1.2 **Fail-Safe:** Hose, Hose Assemblies and Fittings can and do fail without warning for many reasons. Design all systems and equipment in a fail safe mode, so that failure of the Hose, Hose Assembly or Fitting will not endanger persons or property.

1.3 **Distribution:** Provide a copy of this safety guide to each person responsible for selecting or using Hose and Fitting products. Do not select or use Parker Hose or Fittings without thoroughly reading and understanding this safety guide as well as the specific Parker publications for the Products.

1.4 **User Responsibility:** Due to the wide variety of operating conditions and applications for Hose and Fittings, Parker does not represent or warrant that any particular Hose or Fitting is suitable for any specific end use system. This safety guide does not analyze all technical parameters that must be considered in selecting a product. The user, through its own analysis and testing, is solely responsible for:

- Making the final selection of the Products.
- Assuring that the user's requirements are met and that the application presents no health or safety hazards.
- Providing all appropriate health and safety warnings on the equipment on which the Products are used.
- Assuring compliance with all applicable government and industry standards.

1.5 **Additional Questions:** Call the appropriate Parker technical service department if you have any questions or require any additional information. See the Parker publication for the Products being considered or used, or call 1 800 CPARKER, or go to www.parker.com, for telephone numbers of the appropriate technical service department.

2.0 HOSE AND FITTING SELECTION INSTRUCTIONS

2.1 **Electrical Conductivity:** Certain applications require that the Hose be nonconductive to prevent electrical current flow. Other applications require the Hose and the Fittings and the Hose/Fitting interface to be sufficiently conductive to drain off static electricity. Extreme care must be exercised when selecting Hose and Fittings for these or any other applications in which electrical conductivity or nonconductivity is a factor.

The electrical conductivity or nonconductivity of Hose and Fittings is dependent upon many factors and may be susceptible to change. These factors include but are not limited to the various materials used to make the Hose and the Fittings, Fitting finish (some Fitting finishes are electrically conductive while others are nonconductive), manufacturing methods (including moisture control), how the Fittings contact the Hose, age and amount of deterioration or damage or other changes, moisture content of the Hose at any particular time, and other factors.

The following are considerations for electrically nonconductive and conductive

Hose. For other applications consult the individual catalog pages and the appropriate industry or regulatory standards for proper selection.

2.1.1 **Electrically Nonconductive Hose:** Certain applications require that the Hose be nonconductive to prevent electrical current flow or to maintain electrical isolation. For applications that require Hose to be electrically nonconductive, including but not limited to applications near high voltage electric lines, only special nonconductive Hose can be used. The manufacturer of the equipment in which the nonconductive Hose is to be used must be consulted to be certain that the Hose and Fittings that are selected are proper for the application. Do not use any Parker Hose or Fittings for any such application requiring nonconductive Hose, including but not limited to applications near high voltage electric lines, unless (i) the application is expressly approved in the Parker technical publication for the product, (ii) the Hose is marked "nonconductive", and (iii) the manufacturer of the equipment on which the Hose is to be used specifically approves the particular Parker Hose and Fittings for such use.

2.1.2 **Electrically Conductive Hose:** Parker manufactures special Hose for certain applications that require electrically conductive Hose.

Parker manufactures special Hose for conveying paint in airless paint spraying applications. This Hose is labeled "Electrically Conductive Airless Paint Spray Hose" on its layline and packaging. This Hose must be properly connected to the appropriate Parker Fittings and properly grounded in order to dissipate dangerous static charge buildup, which occurs in all airless paint spraying applications. Do not use any other Hose for airless paint spraying, even if electrically conductive. Use of any other Hose or failure to properly connect the Hose can cause a fire or an explosion resulting in death, personal injury, and property damage.

Parker manufactures a special Hose for certain compressed natural gas ("CNG") applications where static electricity buildup may occur. Parker CNG Hose assemblies comply with the requirements of ANSI/IAS NGV 4.2-1999; CSA 12.52-M99, "Hoses for Natural Gas Vehicles and Dispensing Systems" (www.ansi.org). This Hose is labeled "Electrically Conductive for CNG Use" on its layline and packaging. This Hose must be properly connected to the appropriate Parker Fittings and properly grounded in order to dissipate dangerous static charge buildup, which occurs in, for example, high velocity CNG dispensing or transfer. Do not use any other Hose for CNG applications where static charge buildup may occur, even if electrically conductive. Use of other Hoses in CNG applications or failure to properly connect or ground this Hose can cause a fire or an explosion resulting in death, personal injury, and property damage. Care must also be taken to protect against CNG permeation through the Hose wall. See section 2.6, Permeation, for more information. Parker CNG Hose is intended for dispenser and vehicle use at a maximum temperature of 180°F (82°C). Parker CNG Hose should not be used in confined spaces or unventilated areas or areas exceeding 180°F (82°C). Final assemblies must be tested for leaks. CNG Hose Assemblies should be tested on a monthly basis for conductivity per ANSI/IAS NGV 4.2-1999; CSA 12.52-M99.

Parker manufactures special Hose for aerospace in flight applications. Aerospace in flight applications employing Hose to transmit fuel, lubricating fluids and hydraulic fluids require a special Hose with a conductive inner tube. This Hose for in flight applications is available only from Parker's Stratoflex Products Division. Do not use any other Parker Hose for in flight applications, even if electrically conductive. Use of other Hoses for in flight applications or failure to properly connect or ground this Hose can cause a fire or an explosion resulting in death, personal injury and property damage. These Hose assemblies for in flight applications must meet all applicable aerospace industry, aircraft engine and aircraft requirements.

Safety Guide

2.2 Pressure: Hose selection must be made so that the published maximum working pressure of the Hose and Fittings are equal to or greater than the maximum system pressure. The maximum working pressure of a Hose Assembly is the lower of the respective published maximum working pressures of the Hose and the Fittings used. Surge pressures or peak transient pressures in the system must be below the published maximum working pressure for the Hose. Surge pressures and peak pressures can usually only be determined by sensitive electrical instrumentation that measures and indicates pressures at millisecond intervals. Mechanical pressure gauges indicate only average pressures and cannot be used to determine surge pressures or peak transient pressures. Published burst pressure ratings for Hose is for manufacturing test purposes only and is no indication that the Product can be used in applications at the burst pressure or otherwise above the published maximum recommended working pressure.

2.3 Suction: Hoses used for suction applications must be selected to insure that the Hose will withstand the vacuum and pressure of the system. Improperly selected Hose may collapse in suction application.

2.4 Temperature: Be certain that fluid and ambient temperatures, both steady and transient, do not exceed the limitations of the Hose. Temperatures below and above the recommended limit can degrade Hose to a point where a failure may occur and release fluid. Properly insulate and protect the Hose Assembly when routing near hot objects (e.g. manifolds). Do not use any Hose in any application where failure of the Hose could result in the conveyed fluids (or vapors or mist from the conveyed fluids) contacting any open flame, molten metal, or other potential fire ignition source that could cause burning or explosion of the conveyed fluids or vapors.

2.5 Fluid Compatibility: Hose Assembly selection must assure compatibility of the Hose tube, cover, reinforcement, and Fittings with the fluid media used. See the fluid compatibility chart in the Parker publication for the product being considered or used. This information is offered only as a guide. Actual service life can only be determined by the end user by testing under all extreme conditions and other analysis.

Hose that is chemically compatible with a particular fluid must be assembled using Fittings and adapters containing likewise compatible seals.

2.6 Permeation: Permeation (that is, seepage through the Hose) will occur from inside the Hose to outside when Hose is used with gases, liquid and gas fuels, and refrigerants (including but not limited to such materials as helium, diesel fuel, gasoline, natural gas, or LPG). This permeation may result in high concentrations of vapors which are potentially flammable, explosive, or toxic, and in loss of fluid. Dangerous explosions, fires, and other hazards can result when using the wrong Hose for such applications. The system designer must take into account the fact that this permeation will take place and must not use Hose if this permeation could be hazardous. The system designer must take into account all legal, government, insurance, or any other special regulations which govern the use of fuels and refrigerants. Never use a Hose even though the fluid compatibility is acceptable without considering the potential hazardous effects that can result from permeation through the Hose Assembly.

Permeation of moisture from outside the Hose to inside the Hose will also occur in Hose assemblies, regardless of internal pressure. If this moisture permeation would have detrimental effects (particularly, but not limited to refrigeration and air conditioning systems), incorporation of sufficient drying capacity in the system or other appropriate system safeguards should be selected and used.

2.7 Size: Transmission of power by means of pressurized fluid varies with pressure and rate of flow. The size of the components must be adequate to keep pressure losses to a minimum and avoid damage due to heat generation or excessive fluid velocity.

2.8 Routing: Attention must be given to optimum routing to minimize inherent problems (kinking or flow restriction due to Hose collapse, twisting of the Hose, proximity to hot objects or heat sources). For additional routing recommendations see SAE J1273 and ISO 17165-2. Hose Assemblies have a finite life and if possible, should be installed in a manner that allows for ease of inspection and future replacement. Rubber Hose because of its relative short life, should not be used in residential and commercial buildings for HVAC (heating, ventilating and air conditioning) applications.

2.9 Environment: Care must be taken to insure that the Hose and Fittings are either compatible with or protected from the environment (that is, surrounding conditions) to which they are exposed. Environmental conditions including but not limited to ultraviolet radiation, sunlight, heat, ozone, moisture, water, salt water, chemicals and air pollutants can cause degradation and premature failure.

2.10 Mechanical Loads: External forces can significantly reduce Hose life or cause failure. Mechanical loads which must be considered include excessive flexing, twist, kinking, tensile or side loads, bend radius, and vibration. Use of swivel type Fittings or adapters may be required to insure no twist is put into the Hose. Unusual applications may require special testing prior to Hose selection.

2.11 Physical Damage: Care must be taken to protect Hose from wear, snagging, kinking, bending smaller than minimum bend radius and cutting, any of which can cause premature Hose failure. Any Hose that has been kinked or bent to a radius smaller than the minimum bend radius, and any Hose that has been cut or is cracked or is otherwise damaged should be removed and discarded.

2.12 Proper End Fitting: See instructions 3.2 through 3.5. These recommendations may be substantiated by testing to industry standards such as SAE J517 for hydraulic applications, or MIL-A-5070, AS1339, or AS3517 for Hoses from Parker's Stratoflex Products Division for aerospace applications.

2.13 Length: When establishing a proper Hose length, motion absorption, Hose length changes due to pressure, and Hose and machine tolerances and movement must be considered.

2.14 Specifications and Standards: When selecting Hose and Fittings, government, industry, and Parker specifications and recommendations must be reviewed and followed as applicable.

2.15 Hose Cleanliness: Hose components may vary in cleanliness levels. Care must be taken to insure that the Hose Assembly selected has an adequate level of cleanliness for the application.

2.16 Fire Resistant Fluids: Some fire resistant fluids that are to be conveyed by Hose require use of the same type of Hose as used with petroleum base fluids. Some such fluids require a special Hose, while a few fluids will not work with any Hose at all. See instructions 2.5 and 1.5. The wrong Hose may fail after a very short service. In addition, all liquids but pure water may burn fiercely under certain conditions, and even pure water leakage may be hazardous.

2.17 Radiant Heat: Hose can be heated to destruction without contact by such nearby items as hot manifolds or molten metal. The same heat source may then initiate a fire. This can occur despite the presence of cool air around the Hose.

2.18 Welding or Brazing: When using a torch or arc welder in close proximity to hydraulic lines, the hydraulic lines should be removed or shielded with appropriate fire resistant materials. Flame or weld spatter could burn through the Hose and possibly ignite escaping fluid resulting in a catastrophic failure. Heating of plated parts, including Hose Fittings and adapters, above 450°F (232°C) such as during welding, brazing or soldering may emit deadly gases.

2.19 Atomic Radiation: Atomic radiation affects all materials used in Hose assemblies. Since the long-term effects may be unknown, do not expose Hose assemblies to atomic radiation.

2.20 Aerospace Applications: The only Hose and Fittings that may be used for in flight aerospace applications are those available from Parker's Stratoflex Products Division. Do not use any other Hose or Fittings for in flight applications. Do not use any Hose or Fittings from Parker's Stratoflex Products Division with any other Hose or Fittings, unless expressly approved in writing by the engineering manager or chief engineer of Stratoflex Products Division and verified by the user's own testing and inspection to aerospace industry standards.

2.21 Unlocking Couplings: Ball locking couplings or other Fittings with quick disconnect ability can unintentionally disconnect if they are dragged over obstructions, or if the sleeve or other disconnect member, is bumped or moved enough to cause disconnect. Threaded Fittings should be considered where there is a potential for accidental uncoupling.

3.0 HOSE AND FITTING ASSEMBLY AND INSTALLATION INSTRUCTIONS

3.1 Component Inspection: Prior to assembly, a careful examination of the Hose and Fittings must be performed. All components must be checked for correct style, size, catalog number, and length. The Hose must be examined for cleanliness, obstructions, blisters, cover looseness, kinks, cracks, cuts or any other visible defects. Inspect the Fitting and sealing surfaces for burrs, nicks, corrosion or other imperfections. Do NOT use any component that displays any signs of nonconformance.

3.2 Hose and Fitting Assembly: Do not assemble a Parker Fitting on a Parker Hose that is not specifically listed by Parker for that Fitting, unless authorized in writing by the engineering manager or chief engineer of the appropriate Parker division. Do not assemble a Parker Fitting on another manufacturer's

A

B

C

D

E

Safety Guide

A

Hose or a Parker Hose on another manufacturer's Fitting unless (i) the engineering manager or chief engineer of the appropriate Parker division approves the Assembly in writing or that combination is expressly approved in the appropriate Parker literature for the specific Parker product, and (ii) the user verifies the Assembly and the application through analysis and testing. For Parker Hose that does not specify a Parker Fitting, the user is solely responsible for the selection of the proper Fitting and Hose Assembly procedures. See instruction 1.4.

To prevent the possibility of problems such as leakage at the Fitting or system contamination, it is important to completely remove all debris from the cutting operation before installation of the Fittings. The Parker published instructions must be followed for assembling the Fittings on the Hose. These instructions are provided in the Parker Fitting catalog for the specific Parker Fitting being used, or by calling 1 800 CPARKER, or at www.parker.com.

3.3 Related Accessories: Do not crimp or swage any Parker Hose or Fitting with anything but the listed swage or crimp machine and dies in accordance with Parker published instructions. Do not crimp or swage another manufacturer's Fitting with a Parker crimp or swage die unless authorized in writing by the engineering manager or chief engineer of the appropriate Parker division.

3.4 Parts: Do not use any Parker Fitting part (including but not limited to socket, shell, nipple, or insert) except with the correct Parker mating parts, in accordance with Parker published instructions, unless authorized in writing by the engineering manager or chief engineer of the appropriate Parker division.

3.5 Field Attachable/Permanent: Do not reuse any field attachable Hose Fitting that has blown or pulled off a Hose. Do not reuse a Parker permanent Hose Fitting (crimped or swaged) or any part thereof. Complete Hose Assemblies may only be reused after proper inspection under section 4.0. Do not assemble Fittings to any previously used hydraulic Hose that was in service, for use in a fluid power application.

3.6 Pre-Installation Inspection: Prior to installation, a careful examination of the Hose Assembly must be performed. Inspect the Hose Assembly for any damage or defects. DO NOT use any Hose Assembly that displays any signs of nonconformance.

3.7 Minimum Bend Radius: Installation of a Hose at less than the minimum listed bend radius may significantly reduce the Hose life. Particular attention must be given to preclude sharp bending at the Hose to Fitting juncture. Any bending during installation at less than the minimum bend radius must be avoided. If any Hose is kinked during installation, the Hose must be discarded.

3.8 Twist Angle and Orientation: Hose Assembly installation must be such that relative motion of machine components does not produce twisting.

3.9 Securement: In many applications, it may be necessary to restrain, protect, or guide the Hose to protect it from damage by unnecessary flexing, pressure surges, and contact with other mechanical components. Care must be taken to insure such restraints do not introduce additional stress or wear points.

3.10 Proper Connection of Ports: Proper physical installation of the Hose Assembly requires a correctly installed port connection insuring that no twist or torque is transferred to the Hose when the Fittings are being tightened or otherwise during use.

3.11 External Damage: Proper installation is not complete without insuring that tensile loads, side loads, kinking, flattening, potential abrasion, thread damage or damage to sealing surfaces are corrected or eliminated. See instruction 2.10.

3.12 System Checkout: All air entrapment must be eliminated and the system pressurized to the maximum system pressure (at or below the Hose maximum working pressure) and checked for proper function and freedom from leaks. Personnel must stay out of potential hazardous areas while testing and using.

3.13 Routing: The Hose Assembly should be routed in such a manner so if a failure does occur, the escaping media will not cause personal injury or property damage. In addition, if fluid media comes in contact with hot surfaces, open flame or sparks, a fire or explosion may occur. See section 2.4.

3.14 Ground Fault Equipment Protection Devices (GFEPDs): WARNING! Fire and Shock Hazard: To minimize the danger of fire if the heating cable of a Multitube bundle is damaged or improperly installed, use a Ground Fault Equipment Protection Device. Electrical fault currents may be insufficient to trip a conventional circuit breaker.

For ground fault protection, the IEEE 515:1989 (www.ansi.org) standard for heating

cables recommends the use of GFEPDs with a nominal 30 milliampere trip level for "piping systems in classified areas, those areas requiring a high degree of maintenance, or which may be exposed to physical abuse or corrosive atmospheres".

4.0 HOSE AND FITTING MAINTENANCE AND REPLACEMENT INSTRUCTIONS

4.1 Even with proper selection and installation, Hose life may be significantly reduced without a continuing maintenance program. The severity of the application, risk potential from a possible Hose failure, and experience with any Hose failures in the application or in similar applications should determine the frequency of the inspection and the replacement for the Products so that Products are replaced before any failure occurs. A maintenance program must be established and followed by the user and, at minimum, must include instructions 4.2 through 4.7.

4.2 Visual Inspection Hose/Fitting: Any of the following conditions require immediate shut down and replacement of the Hose Assembly:

- Fitting slippage on Hose;
- Damaged, cracked, cut or abraded cover (any reinforcement exposed);
- Hard, stiff, heat cracked, or charred Hose;
- Cracked, damaged, or badly corroded Fittings;
- Leaks at Fitting or in Hose;
- Kinked, crushed, flattened or twisted Hose; and
- Blistered, soft, degraded, or loose cover.

4.3 Visual Inspection All Other: The following items must be tightened, repaired, corrected or replaced as required:

- Leaking port conditions;
- Excess dirt buildup;
- Worn clamps, guards or shields; and
- System fluid level, fluid type, and any air entrapment.

4.4 Functional Test: Operate the system at maximum operating pressure and check for possible malfunctions and leaks. Personnel must avoid potential hazardous areas while testing and using the system. See section 2.2.

4.5 Replacement Intervals: Hose assemblies and elastomeric seals used on Hose Fittings and adapters will eventually age, harden, wear and deteriorate under thermal cycling and compression set. Hose Assemblies and elastomeric seals should be inspected and replaced at specific replacement intervals, based on previous service life, government or industry recommendations, or when failures could result in unacceptable downtime, damage, or injury risk. See section 1.2. Hose and Fittings may be subjected to internal mechanical and/or chemical wear from the conveying fluid and may fail without warning. The user must determine the product life under such circumstances by testing. Also see section 2.5. See section 1.2.

4.6 Hose Inspection and Failure: Hydraulic power is accomplished by utilizing high pressure fluids to transfer energy and do work. Hoses, Fittings and Hose Assemblies all contribute to this by transmitting fluids at high pressures. Fluids under pressure can be dangerous and potentially lethal and, therefore, extreme caution must be exercised when working with fluids under pressure and handling the Hoses transporting the fluids. From time to time, Hose Assemblies will fail if they are not replaced at proper time intervals. Usually these failures are the result of some form of misapplication, abuse, wear or failure to perform proper maintenance. When Hoses fail, generally the high pressure fluids inside escape in a stream which may or may not be visible to the user. Under no circumstances should the user attempt to locate the leak by "feeling" with their hands or any other part of their body. High pressure fluids can and will penetrate the skin and cause severe tissue damage and possibly loss of limb. Even seemingly minor hydraulic fluid injection injuries must be treated immediately by a physician with knowledge of the tissue damaging properties of hydraulic fluid.

If a Hose failure occurs, immediately shut down the equipment and leave the area until pressure has been completely released from the Hose Assembly. Simply

B

C

D

E

Safety Guide & MSDS Statement

shutting down the hydraulic pump may or may not eliminate the pressure in the Hose Assembly. Many times check valves, etc., are employed in a system and can cause pressure to remain in a Hose Assembly even when pumps or equipment are not operating. Tiny holes in the Hose, commonly known as pinholes, can eject small, dangerously powerful but hard to see streams of hydraulic fluid. It may take several minutes or even hours for the pressure to be relieved so that the Hose Assembly may be examined safely.

Once the pressure has been reduced to zero, the Hose Assembly may be taken off the equipment and examined. It must always be replaced if a failure has occurred. Never attempt to patch or repair a Hose Assembly that has failed. Consult the nearest Parker distributor or the appropriate Parker division for Hose Assembly replacement information.

Never touch or examine a failed Hose Assembly unless it is obvious that the Hose no longer contains fluid under pressure. The high pressure fluid is extremely dangerous and can cause serious and potentially fatal injury.

4.7 Elastomeric seals: Elastomeric seals will eventually age, harden, wear and deteriorate under thermal cycling and compression set. Elastomeric seals should be inspected and replaced.

4.8 Refrigerant gases: Special care should be taken when working with refrigeration systems. Sudden escape of refrigerant gases can cause blindness if the escaping gases contact the eye and can cause freezing or other severe injuries if it contacts any other portion of the body.

4.9 Compressed natural gas (CNG): Parker CNG Hose Assemblies should be tested after installation and before use, and at least on a monthly basis per ANSI/IAS NGV 4.2-1999; CSA 12.52-M99 Section 4.2 "Visual Inspection Hose/Fitting". The recommended procedure is to pressurize the Hose and check for leaks and to visually inspect the Hose for damage.

Caution: Matches, candles, open flame or other sources of ignition shall not be used for Hose inspection. Leak check solutions should be rinsed off after use.

5.0 HOSE STORAGE

5.1 Age Control: Hose and Hose Assemblies must be stored in a manner that facilitates age control and first-in and first-out usage based on manufacturing date of the Hose and Hose Assemblies. The shelf life of rubber Hose or Hose Assemblies that have passed visual inspection and a proof test is 10 years (40 quarters) from the date of manufacture. The shelf life of thermoplastic and polytetrafluoroethylene Hose or Hose Assemblies is considered to be unlimited.

5.2 Storage: Stored Hose and Hose Assemblies must not be subjected to damage that could reduce their expected service life and must be placed in a cool, dark and dry area with the ends capped. Stored Hose and Hose Assemblies must not be exposed to temperature extremes, ozone, oils, corrosive liquids or fumes, solvents, high humidity, rodents, insects, ultraviolet light, electromagnetic fields or radioactive materials.

A

B

C

D

E

MSDS (Available upon request.)

Federal OSHA regulation 29 CFR 1910.1200 requires that we transmit to our customers Material Safety Data Sheets for all material covered under the law. If you are an employer in SIC 20-39 who has not yet received them, you are required to obtain them from us and provide the information to employees as directed in Section (b) of the regulation. Please contact the Hose Products Division - Technical Services Department: (PH) 440-943-5700 (FAX) 440-943-3129.

Offer of Sale

The items described in this document and other documents or descriptions provided by Parker Hannifin Corporation, as subsidiaries and its authorized distributors are hereby offered for sale at prices to be established by Parker Hannifin Corporation, its subsidiaries and its authorized distributors. This offer and its acceptance by any customer ("Buyer") shall be governed by all of the following Terms and Conditions. Buyer's order for any such item, when communicated to Parker Hannifin Corporation, its subsidiary or an authorized distributor ("Seller") verbally or in writing, shall constitute acceptance of this offer.

1. **Terms and Conditions of Sale:** All descriptions, quotations, proposals, offers, acknowledgments, acceptances and sales of Seller's products are subject to and shall be governed exclusively by the terms and conditions stated herein. Buyer's acceptance of any offer to sell is limited to these terms and conditions. Any terms or conditions in addition to, or inconsistent with those stated herein, proposed by Buyer in any acceptance of an offer by Seller, are hereby objected to. No such additional, different or inconsistent terms and conditions shall become part of the contract between Buyer and Seller unless expressly accepted in writing by Seller. Seller's acceptance of any offer to purchase by Buyer is expressly conditional upon Buyer's assent to all the terms and conditions stated herein, including any terms in addition to, or inconsistent with those contained in Buyer's offer. Acceptance of Seller's products shall in all events constitute such assent.
2. **Payment:** Payment shall be made by Buyer net 30 days from the date of delivery of the items purchased hereunder. Any claims by Buyer for omissions or shortages in a shipment shall be waived unless Seller receives notice thereof within 30 days after Buyer's receipt of the shipment.
3. **Delivery:** Unless otherwise provided on the face hereof, delivery shall be made F.O.B. Seller's plant. Regardless of the method of delivery, however, risk of loss shall pass to Buyer upon Seller's delivery to a carrier. Any delivery dates shown are approximate only and Seller shall have no liability for any delays in delivery.
4. **Warranty:** Seller warrants that the items sold thereunder shall be free from defects in material or workmanship for a period of 365 days from the date of shipment to Buyer, or 2,000 hours of use, whichever expires first. THIS WARRANTY COMPRISES THE SOLE AND ENTIRE WARRANTY PERTAINING TO ITEMS PROVIDED HEREUNDER. SELLER MAKES NO OTHER WARRANTY, GAURANTEE, OR REPRESENTATION OF ANY KIND WHATSOEVER. ALL OTHER WARRANTIES, INCLUDING BUT NOT LIMITED TO, MERCHANTABILITY AND FITNESS FOR PURPOSE, WHETHER EXPRESS, IMPLIED, OR ARISING BY OPERATION OF LAW, TRADE USAGE, OR COURSE OF DEALING ARE HEREBY DISCLAIMED. NOTWITHSTANDING THE FOREGOING, THERE ARE NO WARRANTIES WHATSOEVER ON ITEMS BUILT OR ACQUIRED WHOLELY OR PARTIALLY, TO BUYER'S DESIGNS OR SPECIFICATIONS.
5. **Limitation Of Remedy:** SELLER'S LIABILITY ARISING FROM OR IN ANY WAY CONNECTED WITH THE ITEMS SOLD OR THIS CONTRACT SHALL BE LIMITED EXCLUSIVELY TO REPAIR OR REPLACEMENT OF THE ITEMS SOLD OR REFUND OF THE PURCHASE PRICE PAID BY BUYER, AT SELLER'S SOLE OPTION. IN NO EVENT SHALL SELLER BE LIABLE FOR ANY INCIDENTAL, CONSEQUENTIAL OR SPECIAL DAMAGES OF ANY KIND OR NATURE WHATSOEVER, INCLUDING BUT NOT LIMITED TO LOST PROFITS ARISING FROM OR IN ANY WAY CONNECTED WITH THIS AGREEMENT OR ITEMS SOLD HEREUNDER, WHETHER ALLEGED TO ARISE FROM BREACH OF CONTRACT, EXPRESS OR IMPLIED WARRANTY, OR IN TORT, INCLUDING WITHOUT LIMITATION, NEGLIGENCE, FAILURE TO WARN OR STRICT LIABILITY.
6. **Changes, Reschedules and Cancellations:** Buyer may request to modify the designs or specifications for the items sold herunder as well as the quantities and delivery dates thereof, or may request to cancel all or part of this order, however, no such requested modification or cancellation shall become part of the contract between Buyer and Seller unless accepted by Seller in a written amendment to this Agreement. Acceptance of any such requested modification or cancellation shall be at Seller's discretion, and shall be upon such terms and conditions as Seller may require.
7. **Special Tooling:** A tooling charge may be imposed for any special tooling, including without limitation, dies, fixtures, molds and patterns, acquired to manufacture items sold pursuant to this contract. Such special tooling shall be and remain Seller's property notwithstanding payment of any charges by Buyer. In no event will Buyer acquire any interest in apparatus belonging to Seller which is utilized in the manufacture of the items sold hereunder, even if such apparatus has been specially converted or adapted for such manufacture and notwithstanding any charges paid by Buyer. Unless otherwise agreed, Seller shall have the right to alter, discard or otherwise dispose of any special tooling or other property in its sole discretion at any time.
8. **Buyer's Property:** Any designs, tools, patterns, materials, drawings, confidential information or equipment furnished by Buyer or any other items which become Buyer's property, may be considered obsolete and may be destroyed by Seller after two (2) consecutive years have elapsed without Buyer placing an order for the items which are manufactured using such property. Seller shall not be responsible for any loss or damage to such property while it is in Seller's possession or control.
9. **Taxes:** Unless otherwise indicated on the face hereof, all prices and charges are exclusive of excise, sales, use, property, occupational or like taxes which may be imposed by any taxing authority upon the manufacture, sale or delivery of the items sold hereunder. If any such taxes must be paid by Seller of Seller is liable for the collection of such tax, the amount thereof shall be in addition to the amounts for the items sold. Buyer agrees to pay all such taxes or to reimburse Seller therefore upon receipt of its invoice. If Buyer claims exemption from any sales, use or other tax imposed by any taxing authority, Buyer shall save Seller harmless from and against any such tax, together with any interest or penalties thereon which may be assessed if the items are held to be taxable.
10. **Indemnity For Infringement of Intellectual Property Rights:** Seller shall have no liability for infringement of any patents, trademarks, copyrights, trade dress, trade secrets or similar rights except as provided in this Part 10. Seller will defend and indemnify Buyer against allegations of infringement of U.S. patents, U.S. trademarks, copyrights, trade dress and trade secrets (hereinafter "Intellectual Property Rights"). Seller will defend at its expense and will pay the cost of any settlement or damages awarded in an action brought against Buyer based on an allegation that an item sold pursuant to this contract infringes in the Intellectual Property Rights of a third party. Seller's obligation to defend and indemnify Buyer is contingent on Buyer notifying Seller within ten (10) days after Buyer becomes aware of such allegations of infringement, and Seller having sole control over the defense of any allegations or actions including all negotiations for settlement or compromise. If an item sold hereunder is subject to a claim that it infringes the Intellectual Property Rights of a third party, Seller may, at its sole expense and options, procure for Buyer the right to continue using said item, replace or modify said item so as to make it noninfringing, or offer to accept return of said item and return the purchase price less a reasonable allowance for depreciation. Notwithstanding the foregoing, Seller shall have no liability for claims of infringement based on information provided by Buyer, or directed to items delivered hereunder for which the designs are specified in whole or part by Buyer, or infringements resulting from the modification, combination or use in a system of any item sold hereunder. The foregoing provisions of this Part 10 shall constitute Seller's sole and exclusive liability and Buyer's sole and exclusive remedy for infringement of Intellectual Property Rights. If a claim is based on information provided by Buyer or if the design for an item delivered hereunder is specified in whole or in part by Buyer, Buyer shall defend and indemnify Seller for all costs, expenses or judgments resulting from any claim that such item infringes any patent, trademark, copyright, trade dress, trade secret or any similiar right.
11. **Force Majeure:** Seller does not assume the risk of and shall not be liable for delay or failure to perform any of Seller's obligations by reason of circumstances beyond the reasonable control of Seller (hereinafter "Events of Force Majeure"). Events of Force Majeure shall include without limitation, accidents, acts of God, strikes or labor disputes, acts, laws, rules or regulations of any government or government agency, fires, floods, delays or failures in delivery of carriers or suppliers, shortages of materials and any other cause beyond Seller's control.
12. **Entire Agreement/Governing Law:** The terms and conditions set forth herein, together with any amendments, modifications and any different terms or conditions expressly accepted by Seller in writing, shall constitute the entire Agreement concerning the items sold, and there are no oral or other representations or agreements which pertain thereto. This Agreement shall be governed in all respects by the law of the State of Ohio. No actions arising out of the sale of the items sold hereunder or this Agreement may be brought by either party more than two (2) years after the cause of action accrues.

A

B

C

D

E

A

B

C

D

E

Parker's Motion & Control Product Groups

At Parker, we're guided by a relentless drive to help our customers become more productive and achieve higher levels of profitability by engineering the best systems for their requirements. It means looking at customer applications from many angles to find new ways to create value. Whatever the motion and control technology need, Parker has the experience, breadth of product and global reach to consistently deliver. No company knows more about motion and control technology than Parker. For further info call 1 800 C-Parker (1 800 272 7537).



Aerospace

Key Markets

Aftermarket services
Commercial transports
Engines
General & business aviation
Helicopters
Launch vehicles
Military aircraft
Missiles
Power generation
Regional transports
Unmanned aerial vehicles

Key Products

Control systems & actuation products
Engine systems & components
Fluid conveyance systems & components
Fluid metering, delivery & atomization devices
Fuel systems & components
Fuel tank inerting systems
Hydraulic systems & components
Thermal management
Wheels & brakes



Automation

Key Markets

Alternative energy
Conveyor & material handling
Factory automation
Food & beverage
Life sciences & medical
Machine tools
Packaging machinery
Paper machinery
Plastics machinery
Primary metals
Safety & security
Semiconductor & electronics
Transportation & automotive

Key Products

AC/DC drives & systems
Air preparation
Electric actuators, gantry robots & slides
Human machine interfaces
Inverters
Manifolds
Miniature fluidics
Pneumatic actuators & grippers
Pneumatic valves & controls
Rotary actuators
Stepper motors, servo motors, drives & controls
Structural extrusions
Vacuum generators, cups & sensors



Climate & Industrial Controls

Key Markets

Agriculture
Air conditioning
Construction Machinery
Food & beverage
Industrial machinery
Life sciences
Oil & gas
Precision cooling
Process
Refrigeration
Transportation

Key Products

Accumulators
Advanced actuators
CO₂ controls
Electronic controllers
Filter driers
Hand shut-off valves
Heat exchangers
Hose & fittings
Pressure regulating valves
Refrigerant distributors
Safety relief valves
Smart pumps
Solenoid valves
Thermostatic expansion valves



Filtration

Key Markets

Aerospace
Food & beverage
Industrial plant & equipment
Life sciences
Marine
Mobile equipment
Oil & gas
Power generation & renewable energy
Process
Transportation
Water Purification

Key Products

Analytical gas generators
Compressed air filters & dryers
Engine air, coolant, fuel & oil filtration systems
Fluid condition monitoring systems
Hydraulic & lubrication filters
Hydrogen, nitrogen & zero air generators
Instrumentation filters
Membrane & fiber filters
Microfiltration
Sterile air filtration
Water desalination & purification filters & systems



Fluid Connectors

Key Markets

Aerial lift
Agriculture
Bulk chemical handling
Construction machinery
Food & beverage
Fuel & gas delivery
Industrial machinery
Life sciences
Marine
Mining
Mobile
Oil & gas
Renewable energy
Transportation

Key Products

Check valves
Connectors for low pressure fluid conveyance
Deep sea umbilicals
Diagnostic equipment
Hose couplings
Industrial hose
Mooring systems & power cables
PTFE hose & tubing
Quick couplings
Rubber & thermoplastic hose
Tube fittings & adapters
Tubing & plastic fittings



Hydraulics

Key Markets

Agriculture
Alternative energy
Construction machinery
Forestry
Industrial machinery
Machine tools
Marine
Material handling
Mining
Oil & gas
Power generation
Refuse vehicles
Renewable energy
Truck hydraulics
Turf equipment

Key Products

Accumulators
Cartridge valves
Electrohydraulic actuators
Human machine interfaces
Hybrid drives
Hydraulic cylinders
Hydraulic motors & pumps
Hydraulic systems
Hydraulic valves & controls
Hydrostatic steering
Integrated hydraulic circuits
Power take-offs
Power units
Rotary actuators
Sensors



Instrumentation

Key Markets

Alternative fuels
Biopharmaceuticals
Chemical & refining
Food & beverage
Marine & shipbuilding
Medical & dental
Microelectronics
Nuclear Power
Offshore oil exploration
Oil & gas
Pharmaceuticals
Power generation
Pulp & paper
Steel
Water/wastewater

Key Products

Analytical Instruments
Analytical sample conditioning products & systems
Chemical injection fittings & valves
Fluoropolymer chemical delivery fittings, valves & pumps
High purity gas delivery fittings, valves, regulators & digital flow controllers
Industrial mass flow meters/ controllers
Process control double block & bleeds
Process control fittings, valves, regulators & manifold valves
Permanent no-weld tube fittings
Precision industrial regulators & flow controllers



Seal

Key Markets

Aerospace
Chemical processing
Consumer
Fluid power
General industrial
Information technology
Life sciences
Microelectronics
Military
Oil & gas
Power generation
Renewable energy
Telecommunications
Transportation

Key Products

Dynamic seals
Elastomeric o-rings
Electro-medical instrument design & assembly
EMI shielding
Extruded & precision-cut, fabricated elastomeric seals
High temperature metal seals
Homogeneous & inserted elastomeric shapes
Medical device fabrication & assembly
Metal & plastic retained composite seals
Shielded optical windows
Silicone tubing & extrusions
Thermal management
Vibration dampening



ENGINEERING YOUR SUCCESS.

Parker Fluid Connectors Group

North American Divisions & Distribution Service Centers

Your complete source for quality tube fittings, hose & hose fittings, brass & composite fittings, quick-disconnect couplings, valves and assembly tools, locally available from a worldwide network of authorized distributors.

Fittings:

Available in inch and metric sizes covering SAE, BSP, DIN, GAZ, JIS and ISO thread configurations, manufactured from steel, stainless steel, brass, aluminum, nylon and thermoplastic.

Hose, Tubing and Bundles:

Available in a wide variety of sizes and materials including rubber, wire-reinforced, thermoplastic, hybrid and custom compounds.

Worldwide Availability:

Parker operates Fluid Connectors manufacturing locations and sales offices throughout North America, South America, Europe and Asia-Pacific.

For information, call toll free...

**1-800-C-PARKER
(1-800-272-7537)**

North American Divisions

Energy Products Division

Stafford, TX
phone 281 566 4500
fax 281 530 5353

Fluid System Connectors Division

Otsego, MI
phone 269 694 9411
fax 269 694 4614

Hose Products Division

Wickliffe, OH
phone 440 943 5700
fax 440 943 3129

Industrial Hose Division

Strongsville, OH
phone 440 268 2120
fax 440 268 2230

Parflex Division

Ravenna, OH
phone 330 296 2871
fax 330 296 8433

Quick Coupling Division

Minneapolis, MN
phone 763 544 7781
fax 763 544 3418

Tube Fittings Division

Columbus, OH
phone 614 279 7070
fax 614 279 7685

Distribution Service Centers

Buena Park, CA

phone 714 522 8840
fax 714 994 1183

Conyers, GA

phone 770 929 0330
fax 770 929 0230

Lakeville, MN

phone 952 469 5000
fax 952 469 5729

Louisville, KY

phone 502 937 1322
fax 502 937 4180

Portland, OR

phone 503 283 1020
fax 503 283 2201

Toledo, OH

phone 419 878 7000
fax 419 878 7001
fax 419 878 7420
(FCG Kit Operations)

Canada

Grimsby, ONT

phone 905 945 2274
fax 905 945 3945
(Contact Grimsby for other Service Center locations.)



Parker Hannifin Corporation

Hose Products Division

30240 Lakeland Boulevard

Wickliffe, OH 44092

phone 440 943 5700

fax 440 943 3129

e-mail HPDSales@Parker.com

www.parker.com